

3J-2I(172・173)

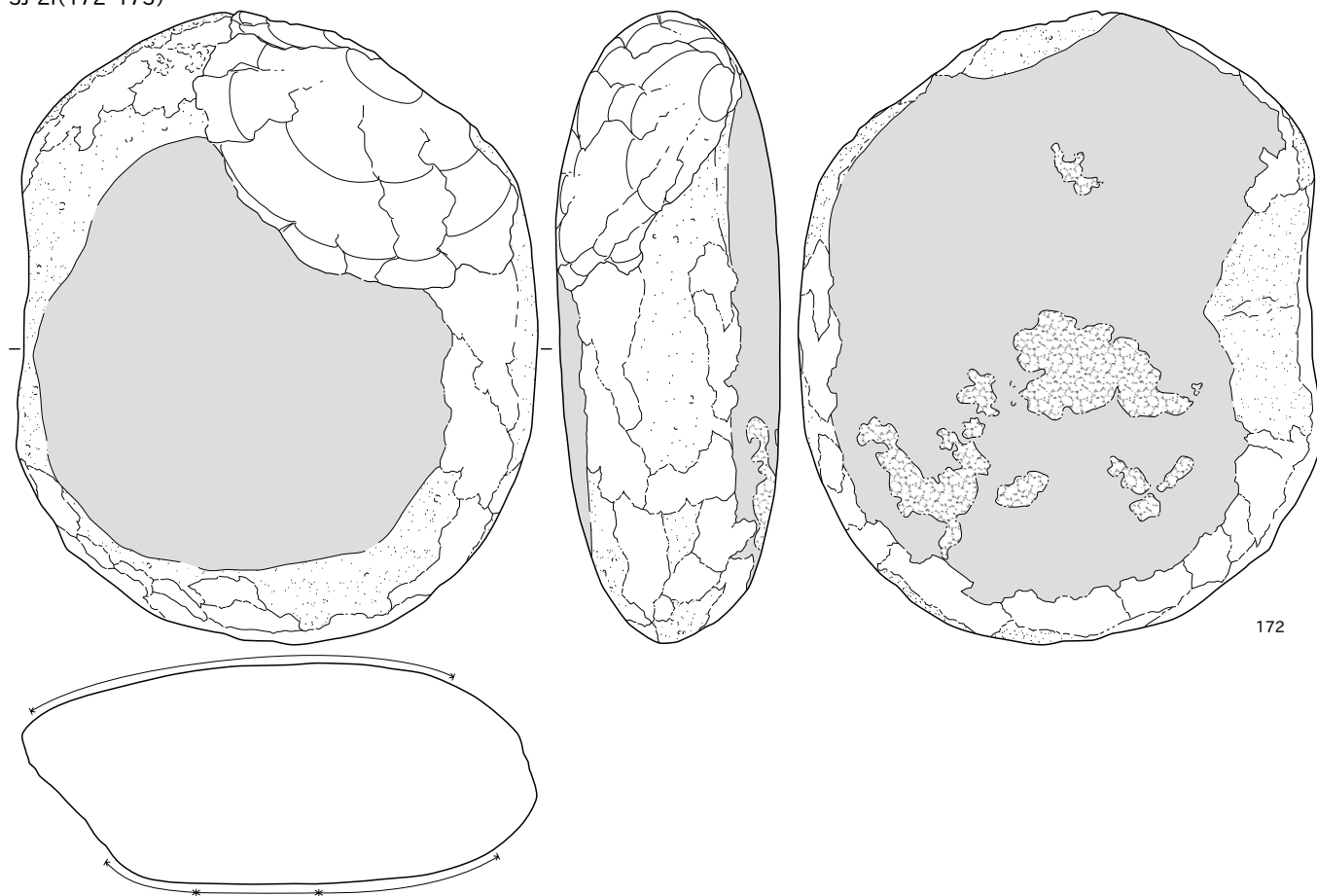

172

173

3J-3H(174・175)

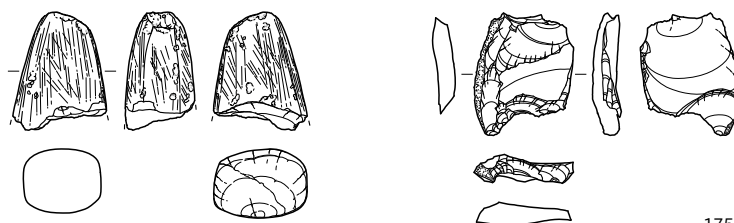

174

175

3J-3I(176・177)

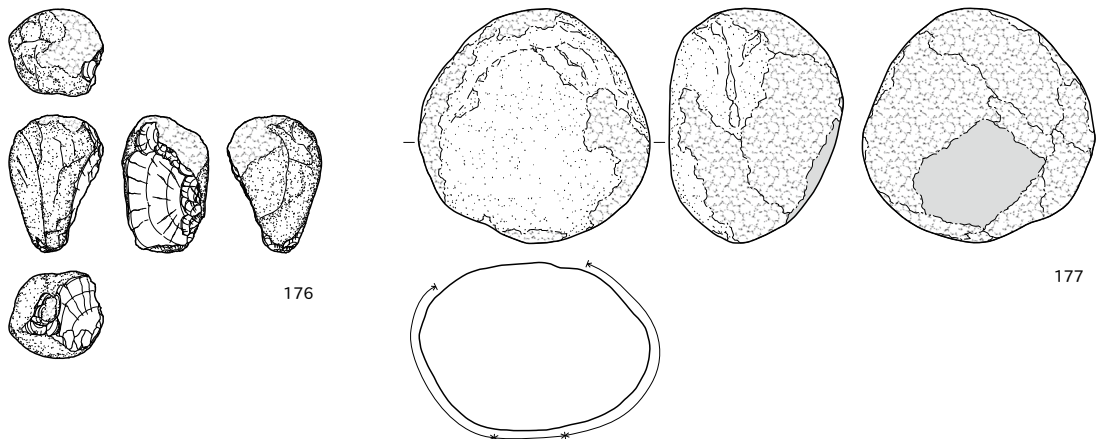

176

177

0 (175) 6cm (3:4)
 0 10cm (1:3)

3J-3I(178)

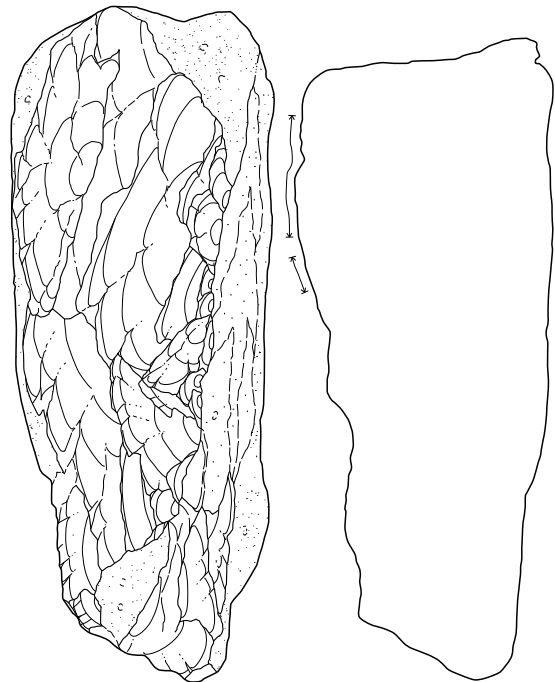
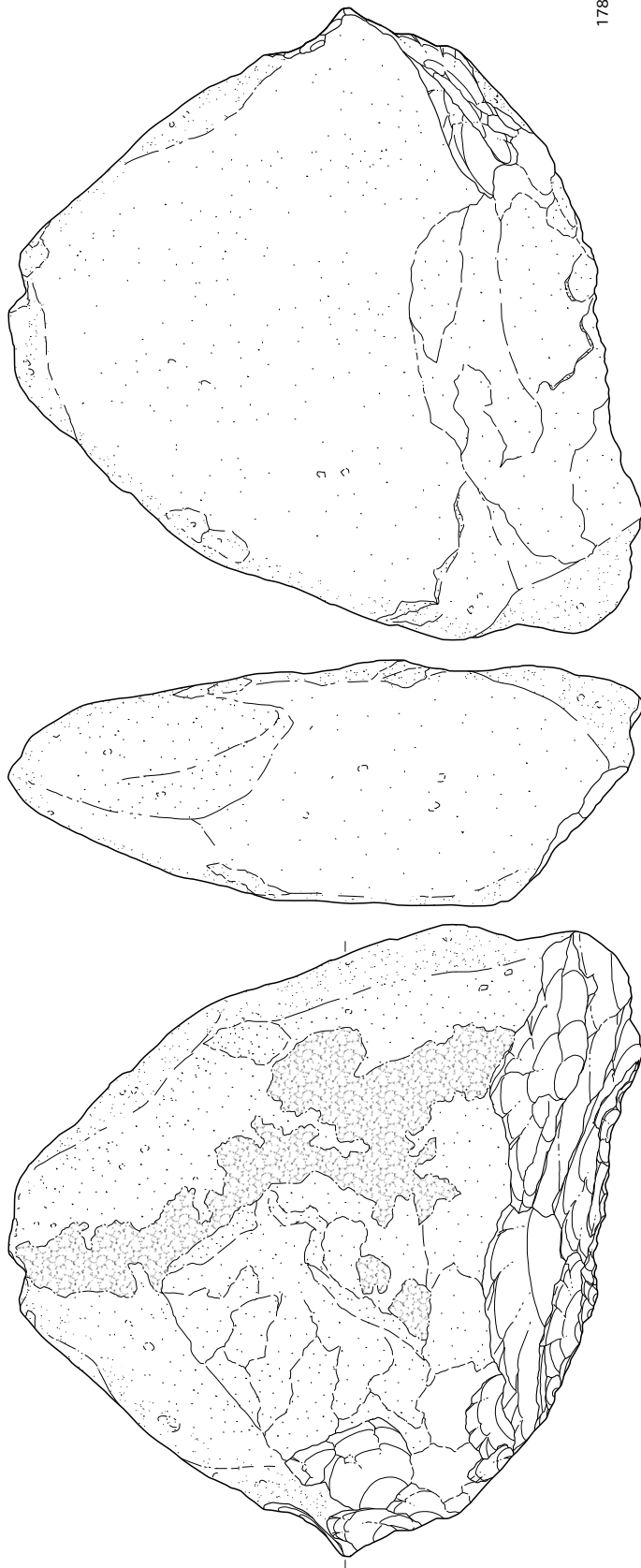

3J-4H(179-180)

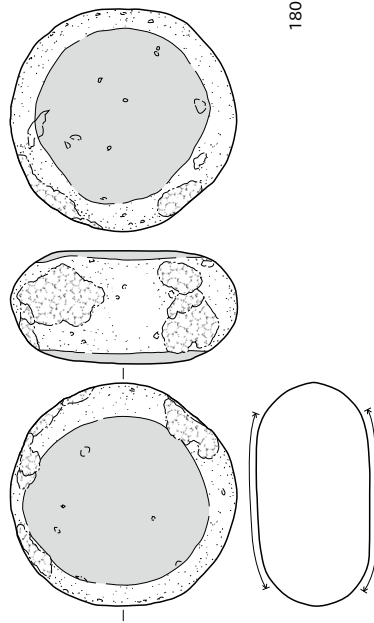
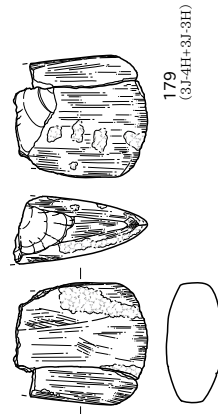

3J-4H(181)

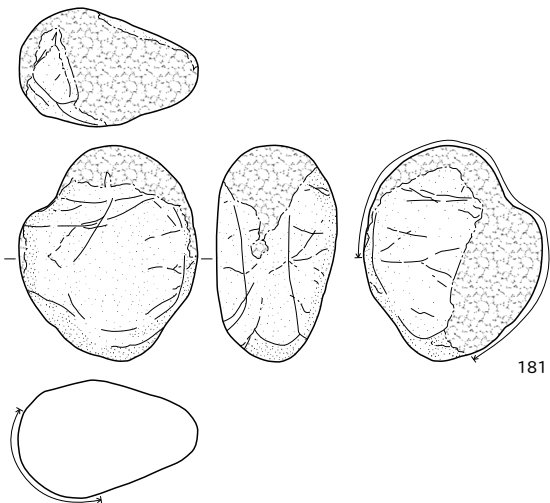

3J-4I(182~185)

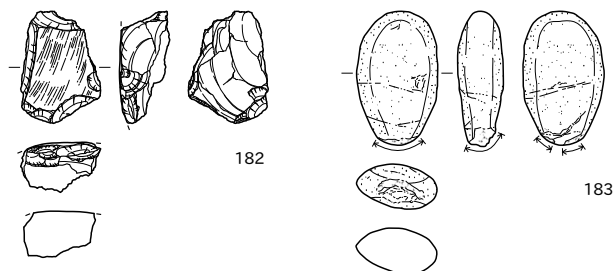

3J-4J(186~188)

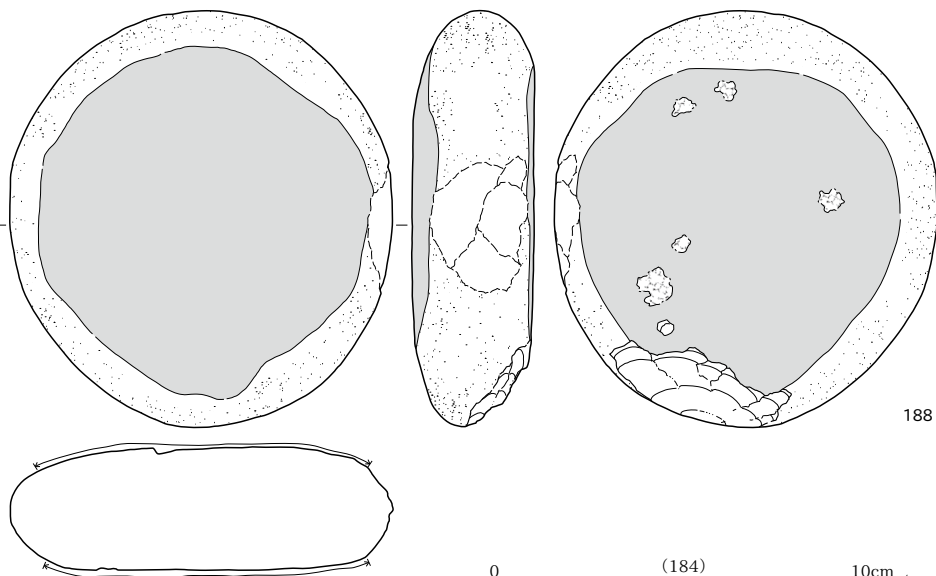
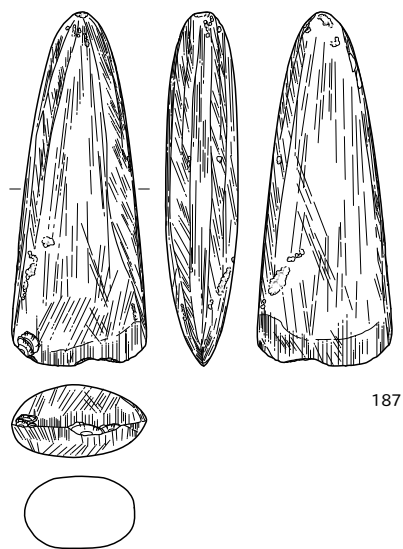
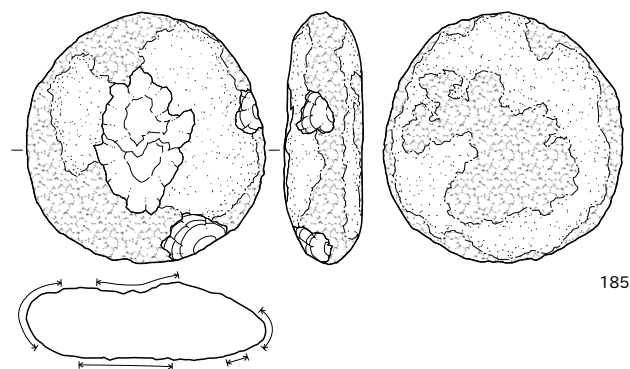
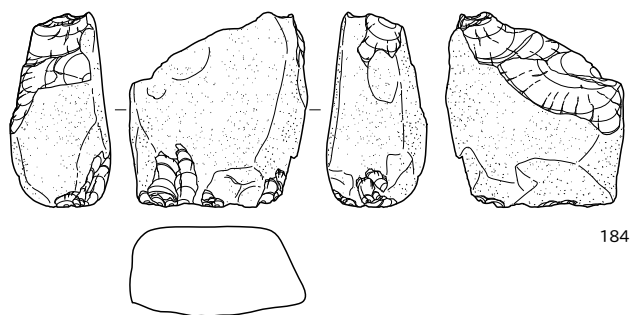
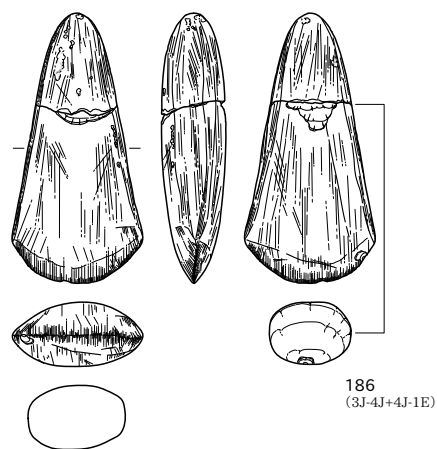

0 (184) 10cm (1:2)
0 10cm (1:3)

3J-5I (190・191)

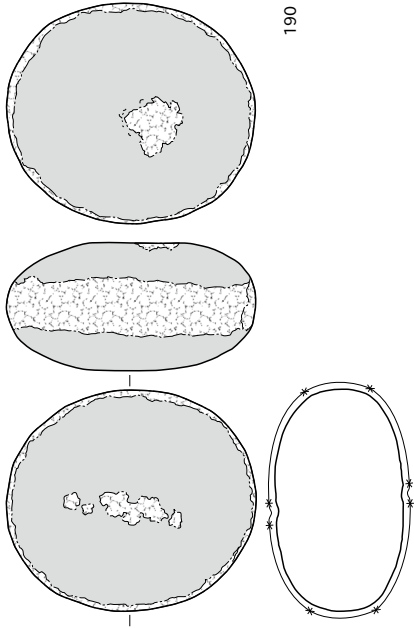

190

3J-4I (189)

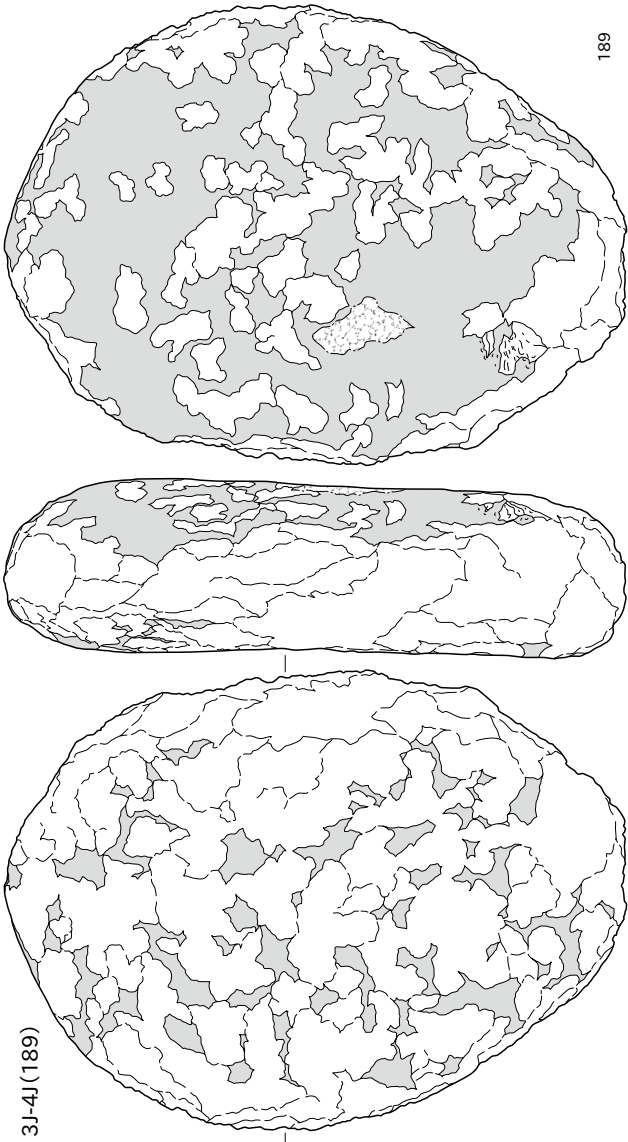

189



191
(3J-5I・J,6H~J,8G-1)



3J-5I (192・193)

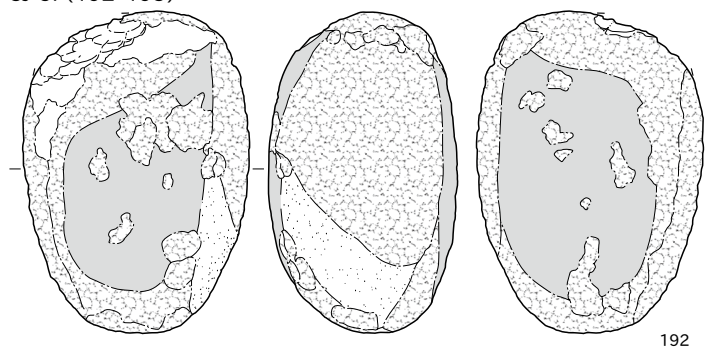

192

193

3J-5J(194~200)

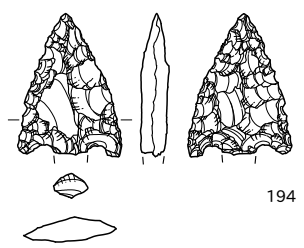
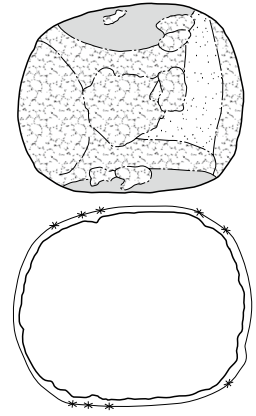

194

195

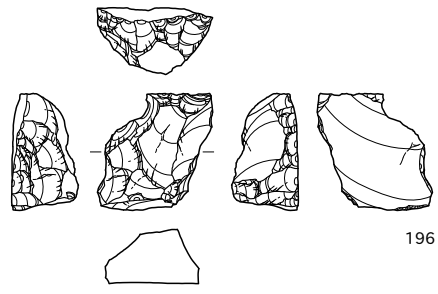

196

198
(3J-5J+3J-5I)

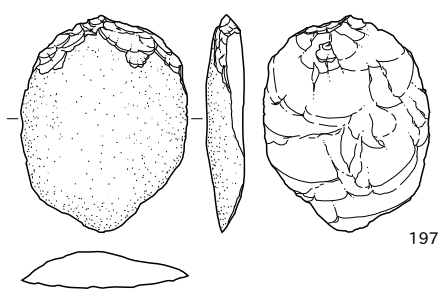

197

199

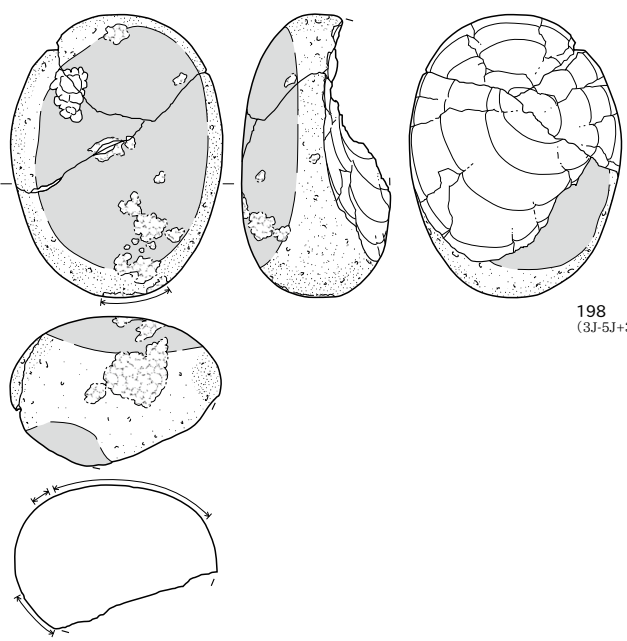

200

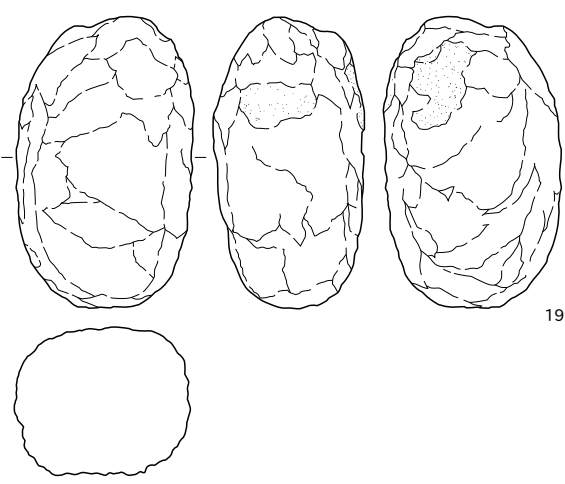

0 (194~196) 6cm (3:4)
0 10cm (1:3)

3J-5J(201~203)

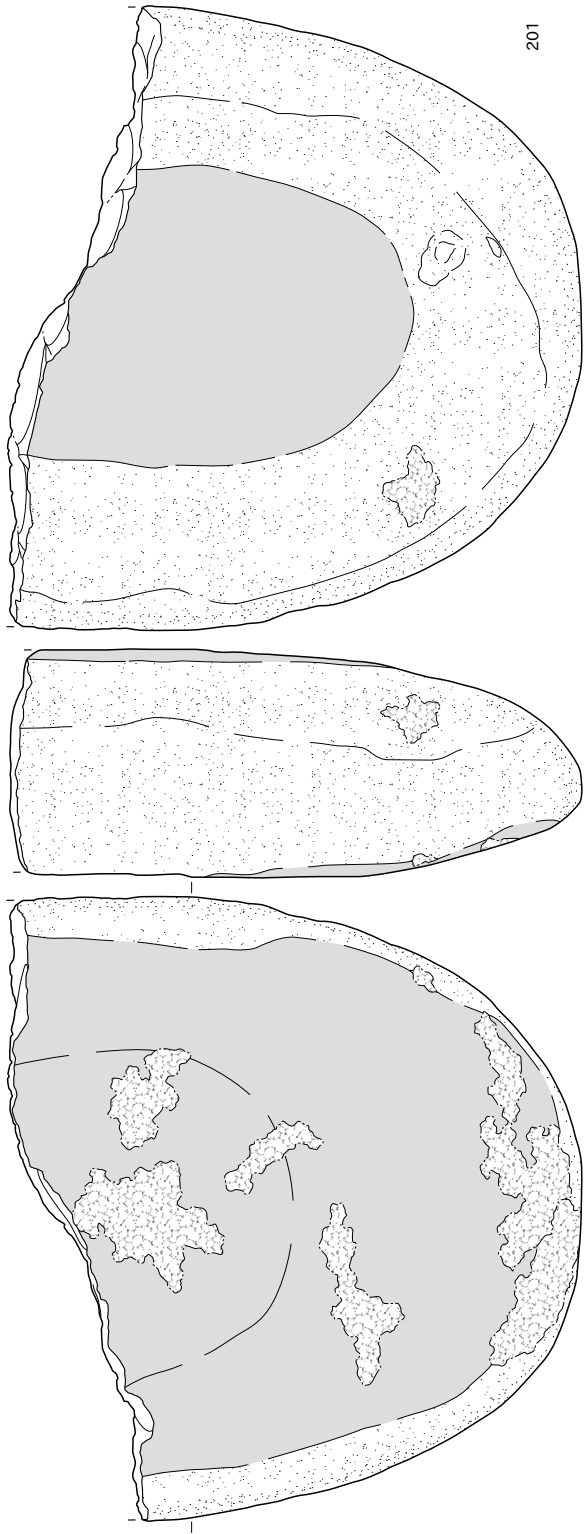

201

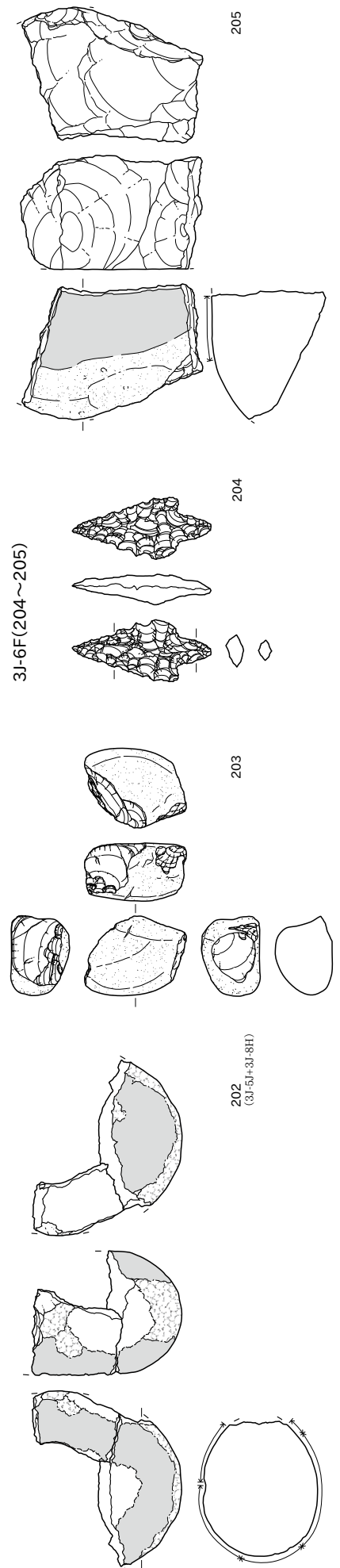
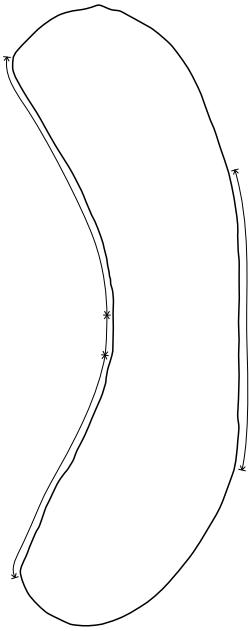

3J-6F(204~205)

202
(3J-5J+3J-8H)

203

204

205



3J-6G(206・207)

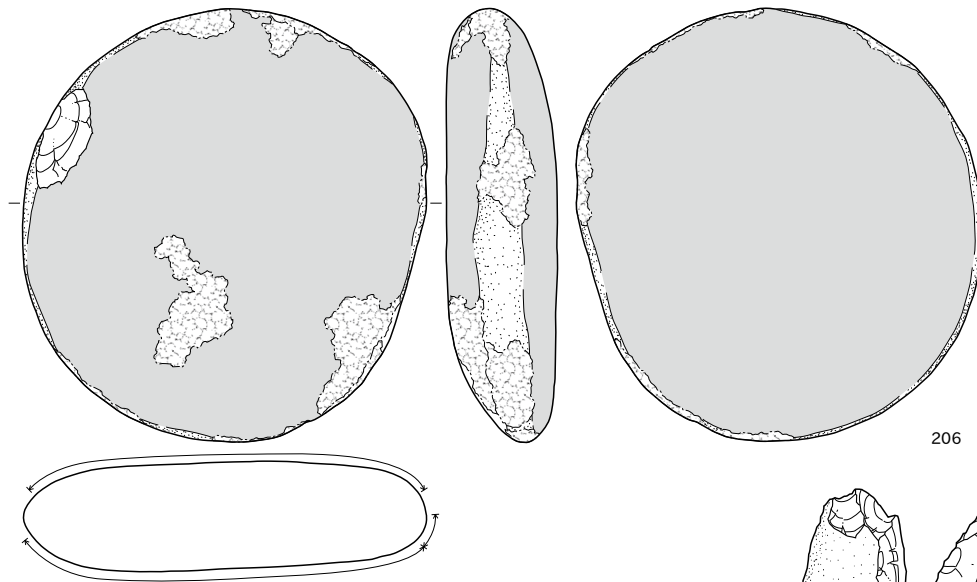

206

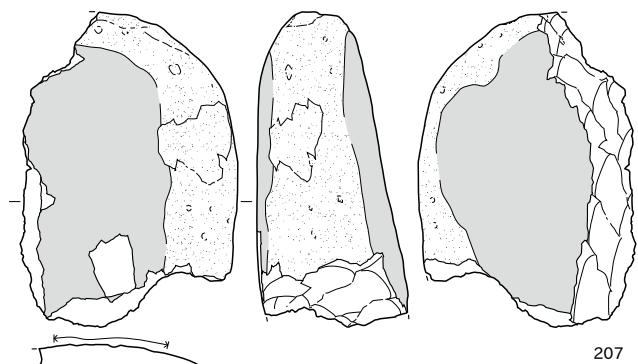

207

3J-6H(208~213)

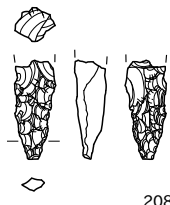

208



209

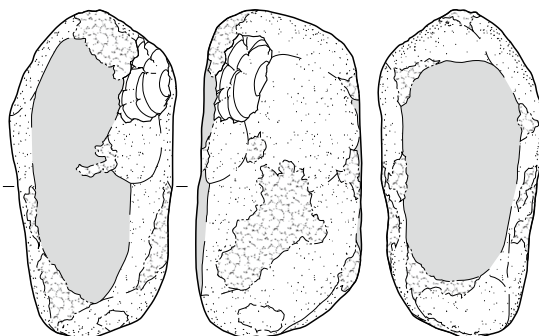

210

211

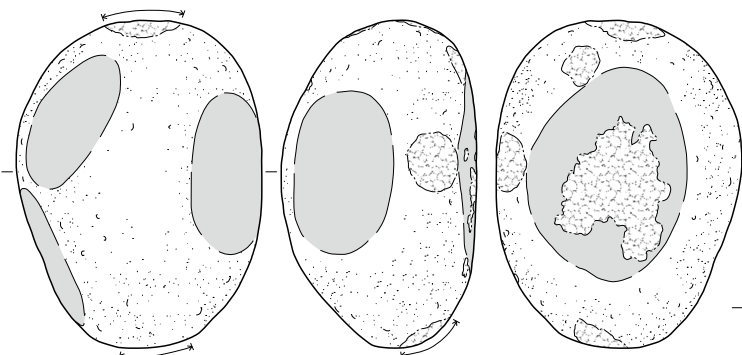

212

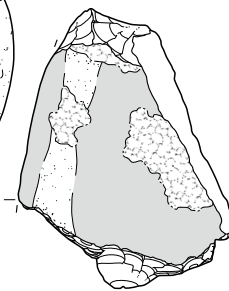

213

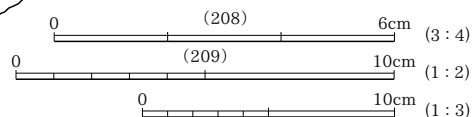
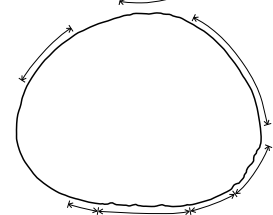

3J-6H(214)

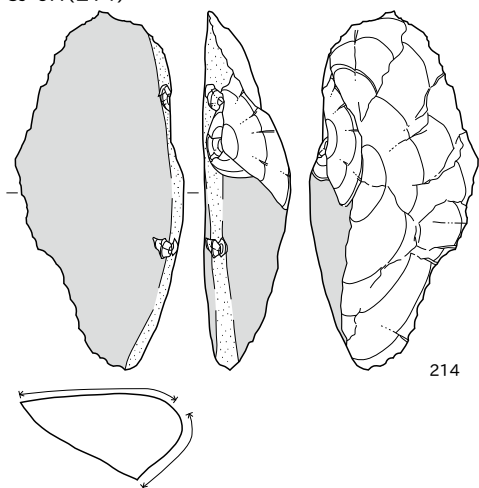

214

3J-6I(215~222)

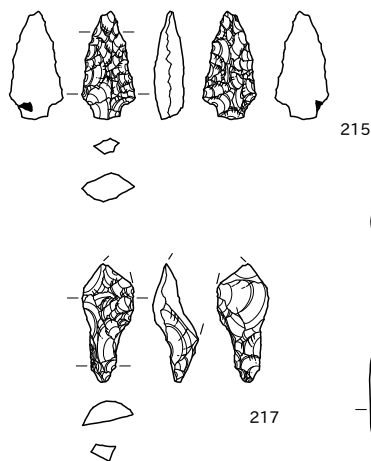

215

217

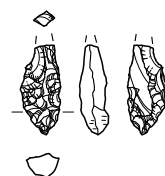

216

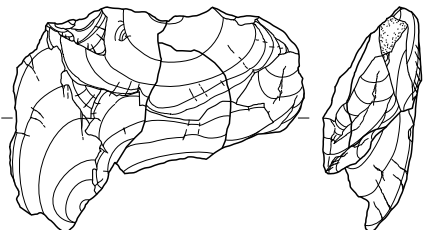

218

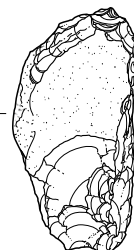
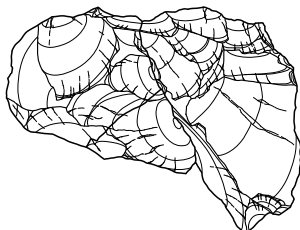
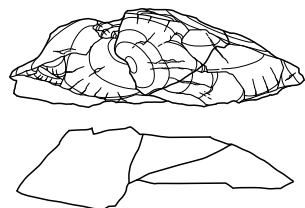

219

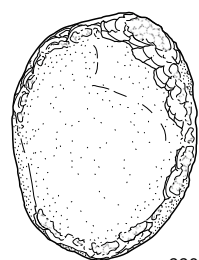
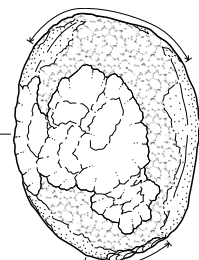
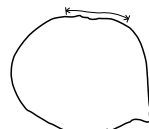

220

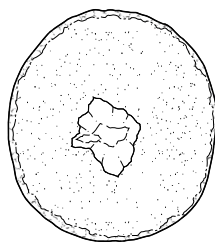
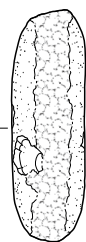
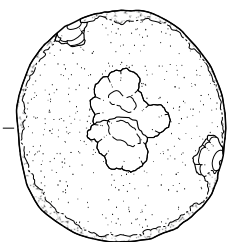
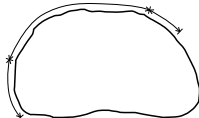

221

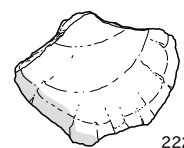
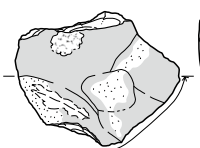
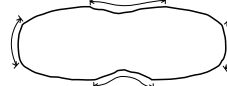

222



3J-6J(223-224)

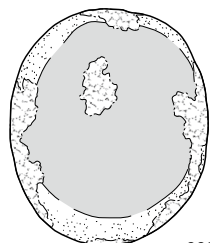
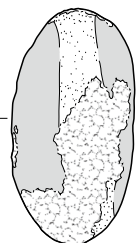
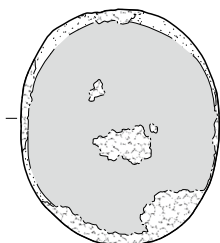

223

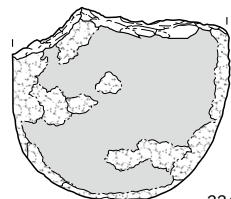
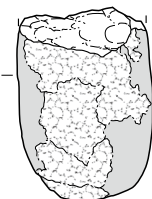
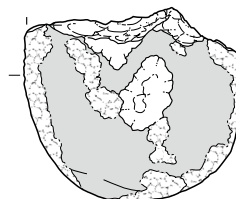
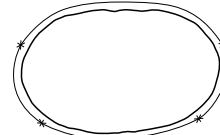

224

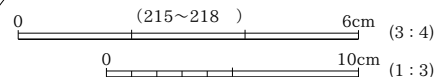
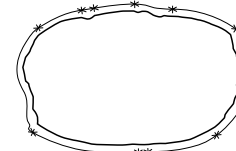

3J-6J(225~228)

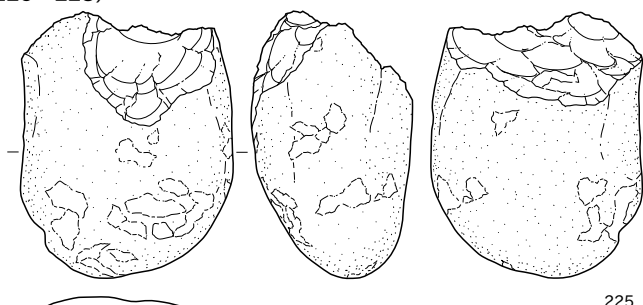

225

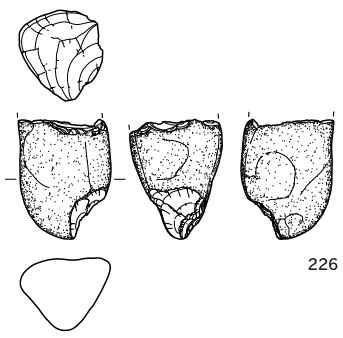

226

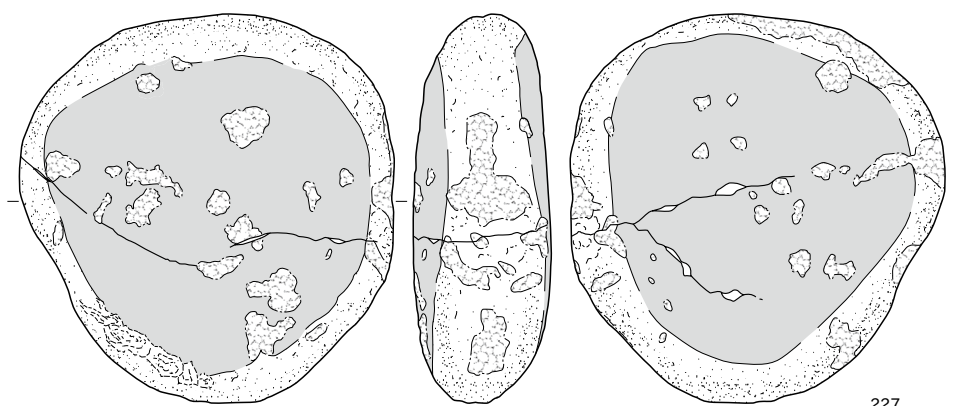
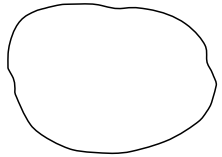

227

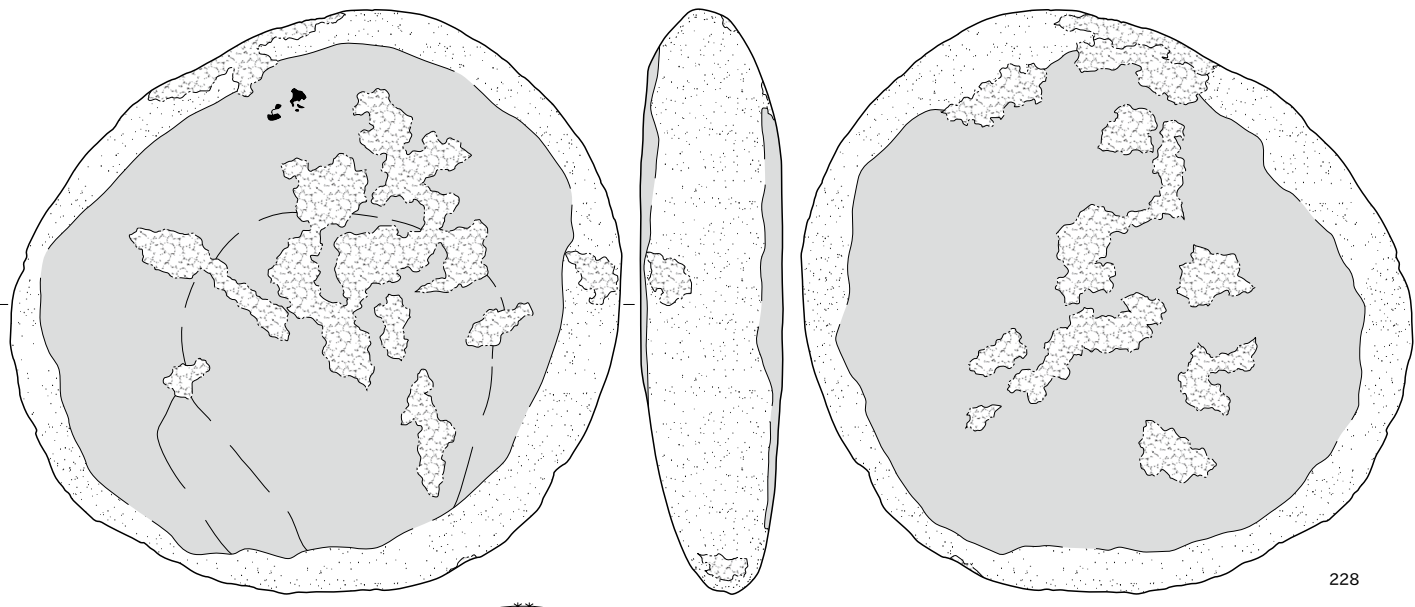
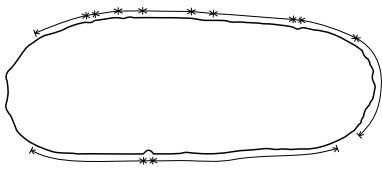

228

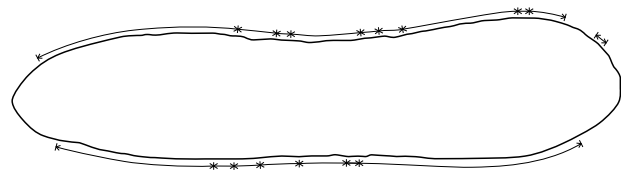

3J-7E(229~231)

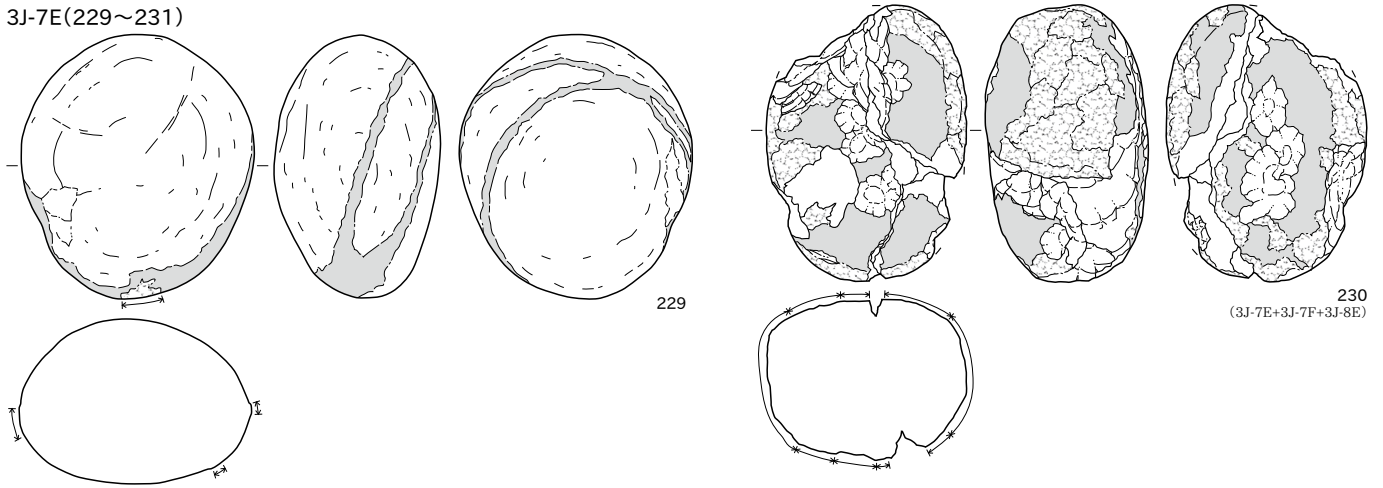

229

230
(3J-7E+3J-7F+3J-8E)

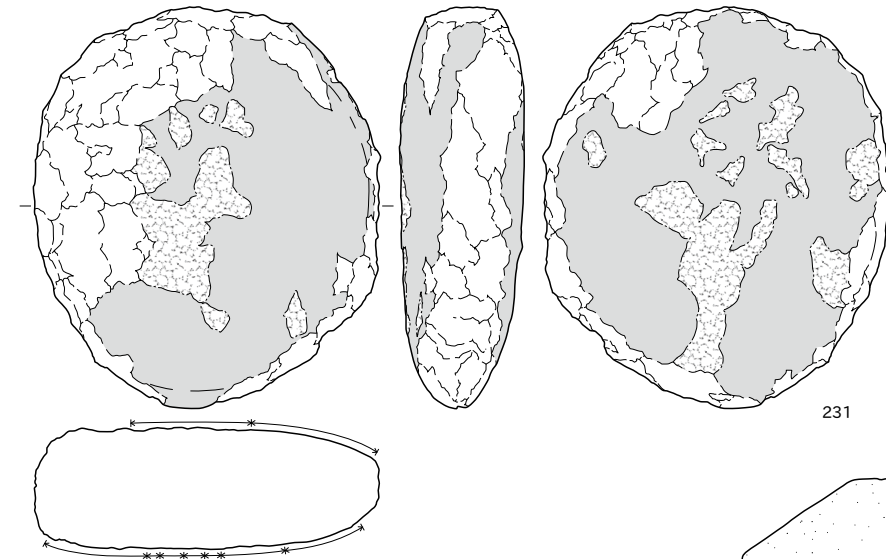

231

3J-7F(232~235)

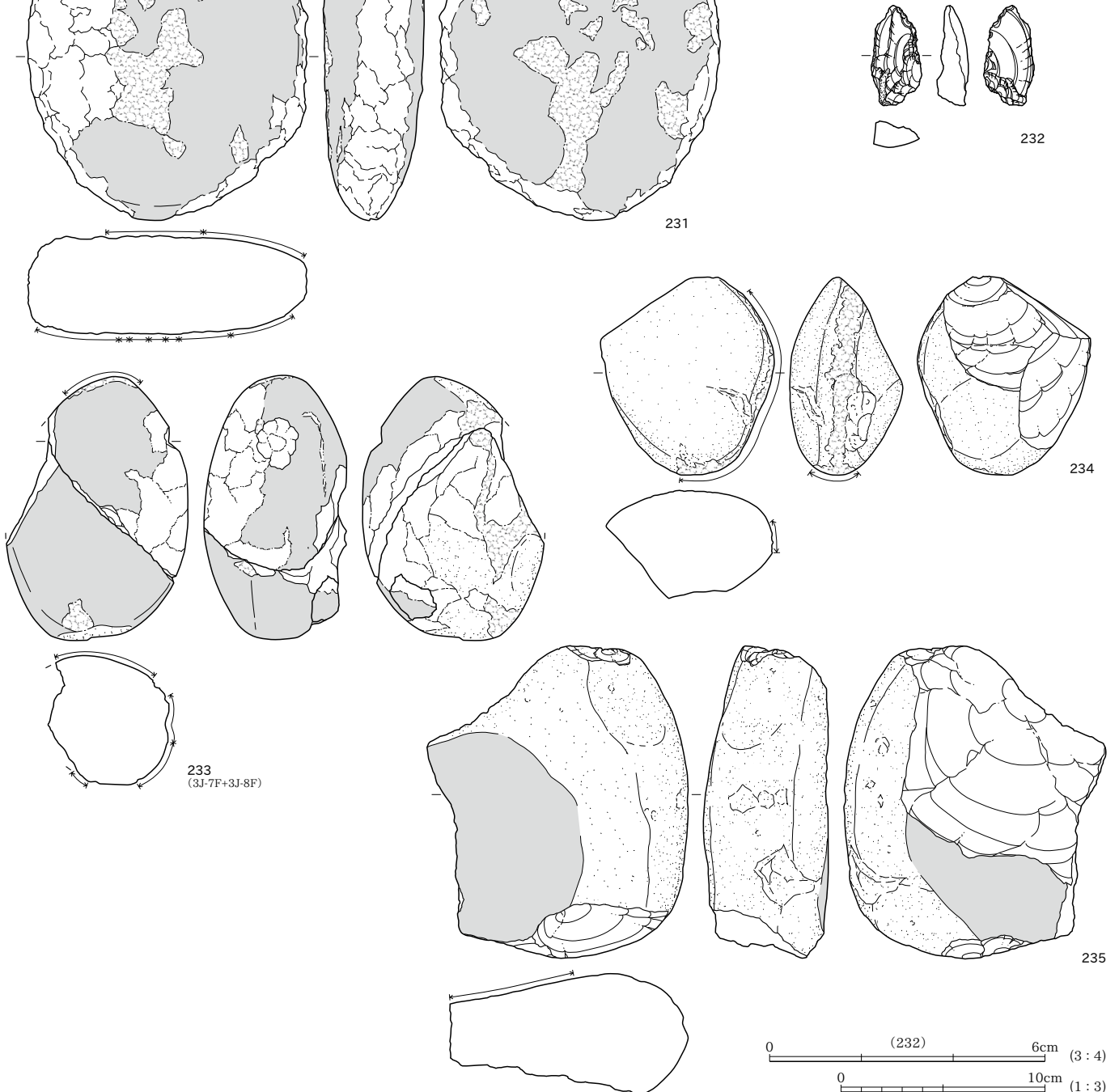

232

233
(3J-7F+3J-8F)

234

235

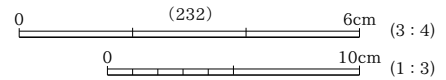

3J-7G(236~241)

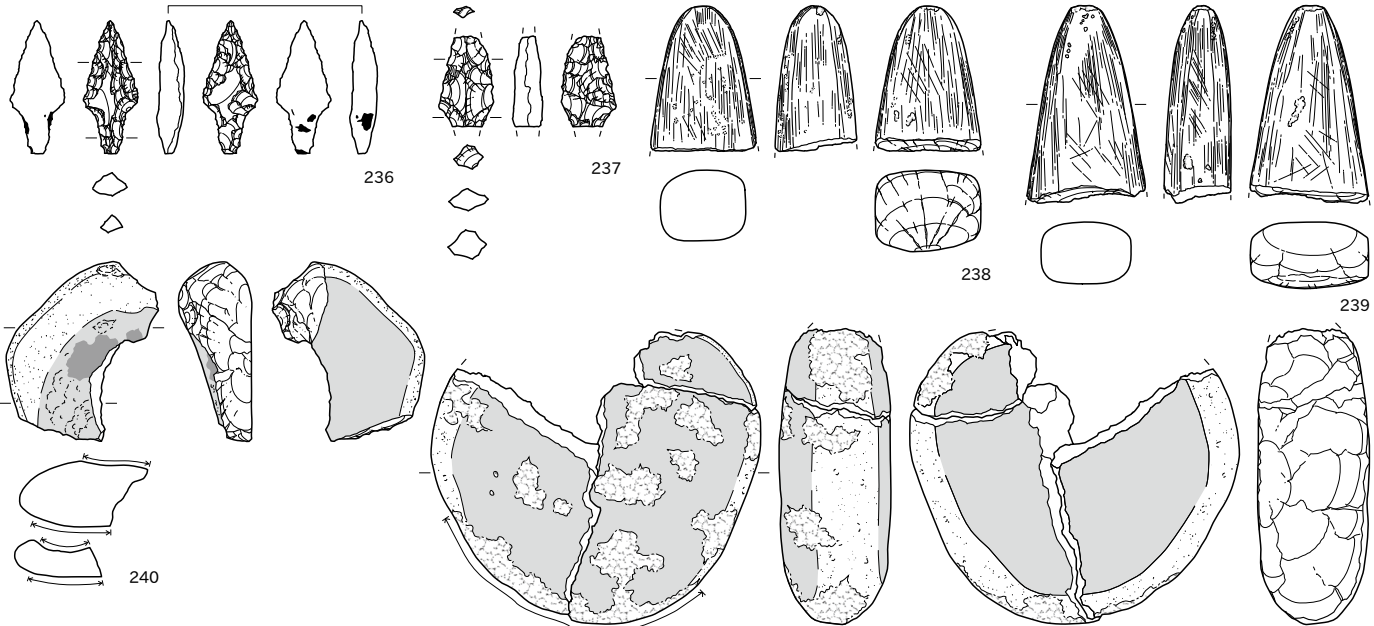

3J-7H(242~247)

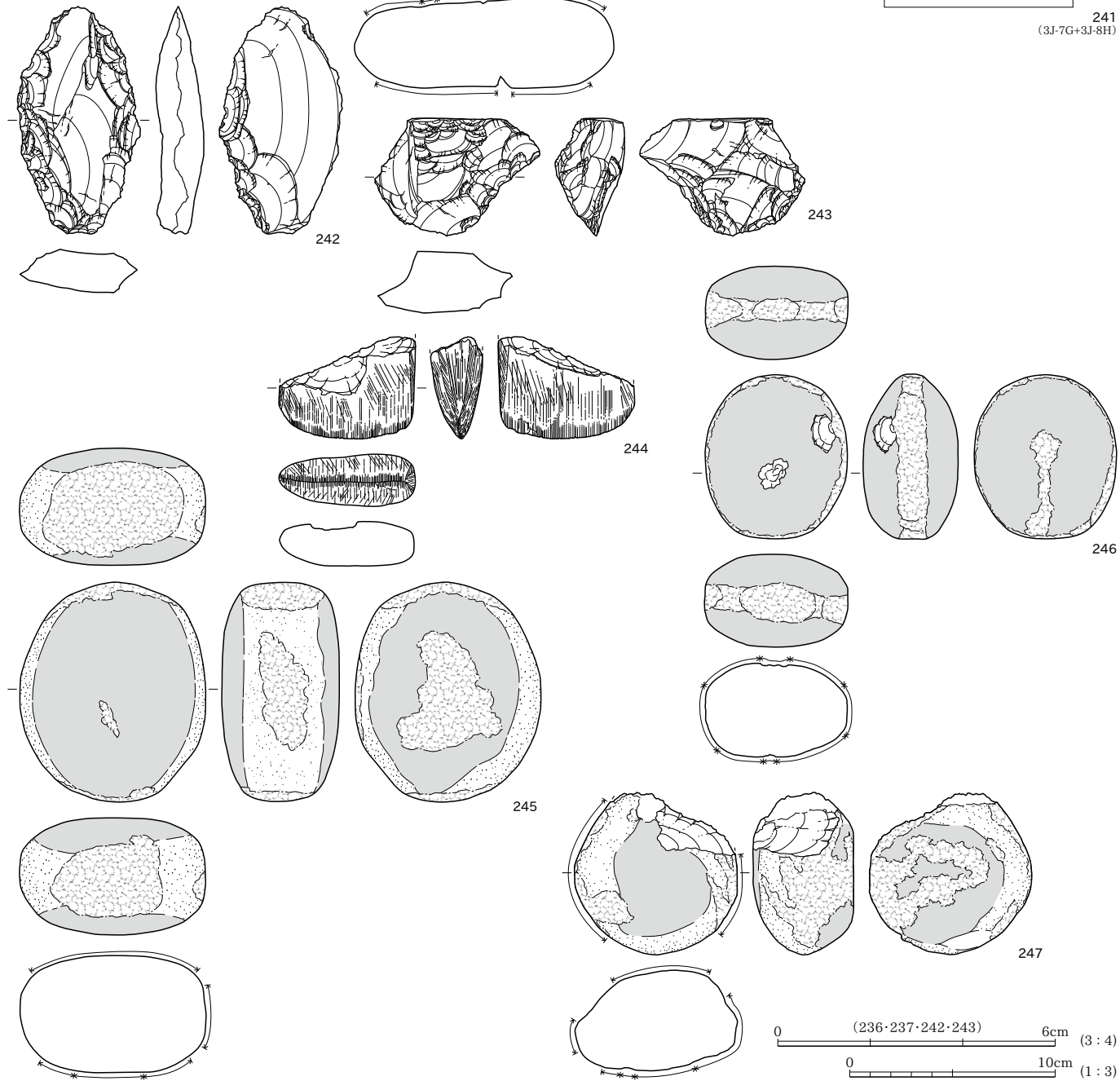

241
(3J-7G+3J-8H)

0 (236·237·242·243) 6cm (3:4)
0 10cm (1:3)

3J-7H(248~253)

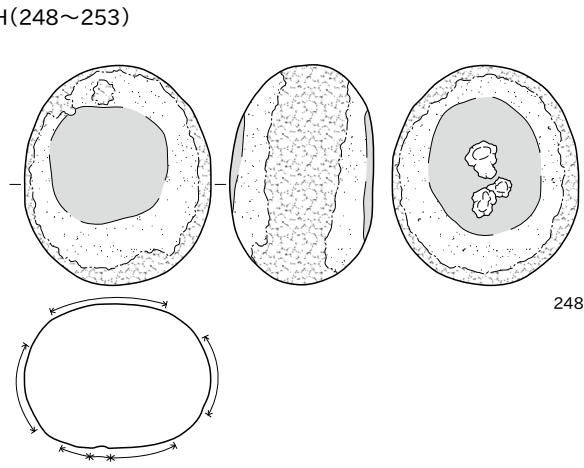

248

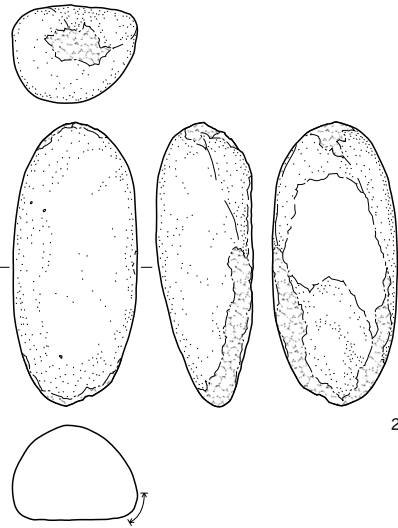

249

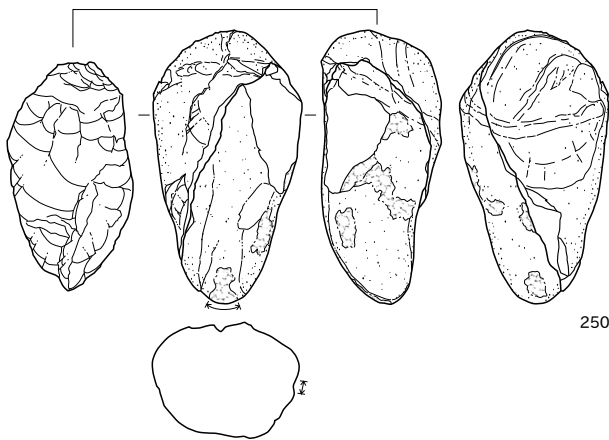

250

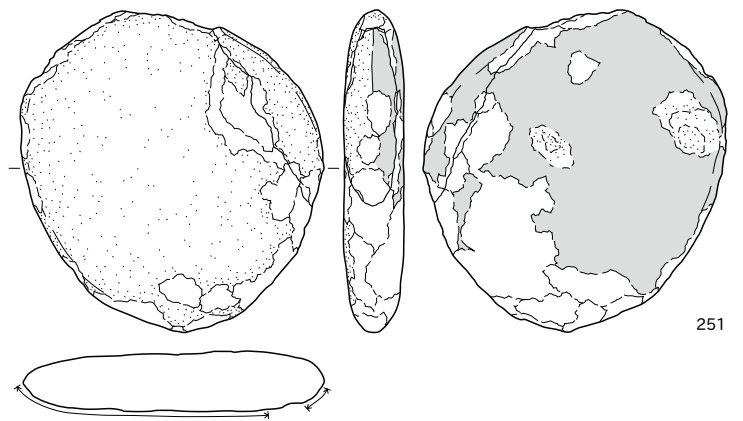

251

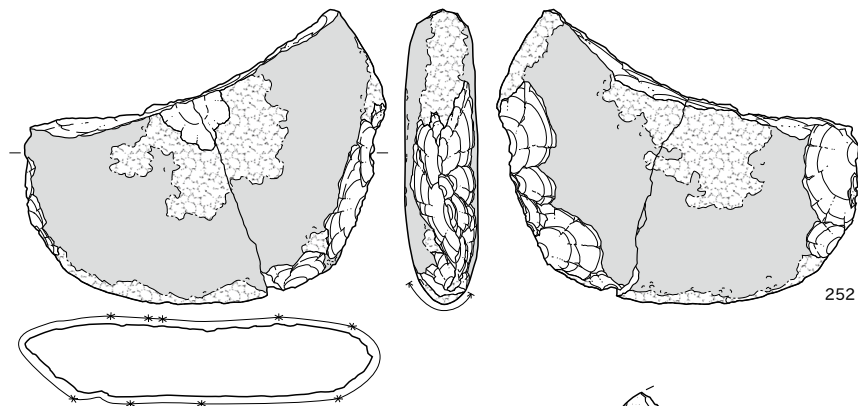

252

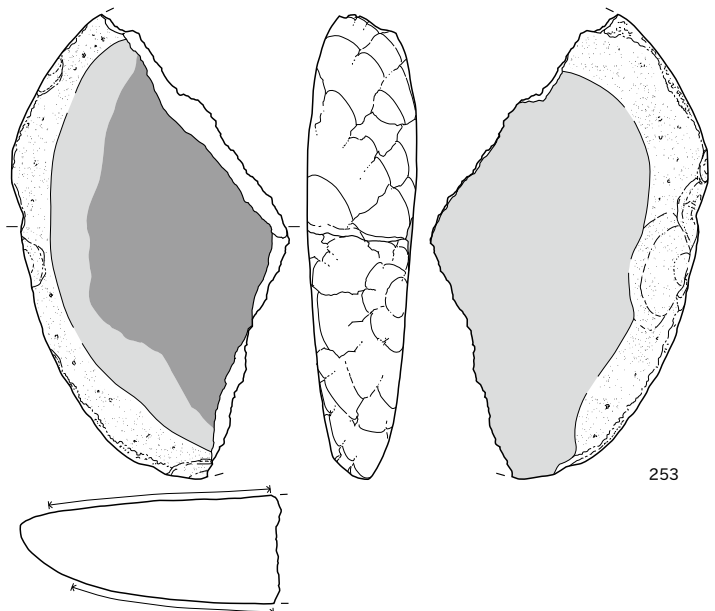

253

3J-71(254・255)

3J-71(256~261)

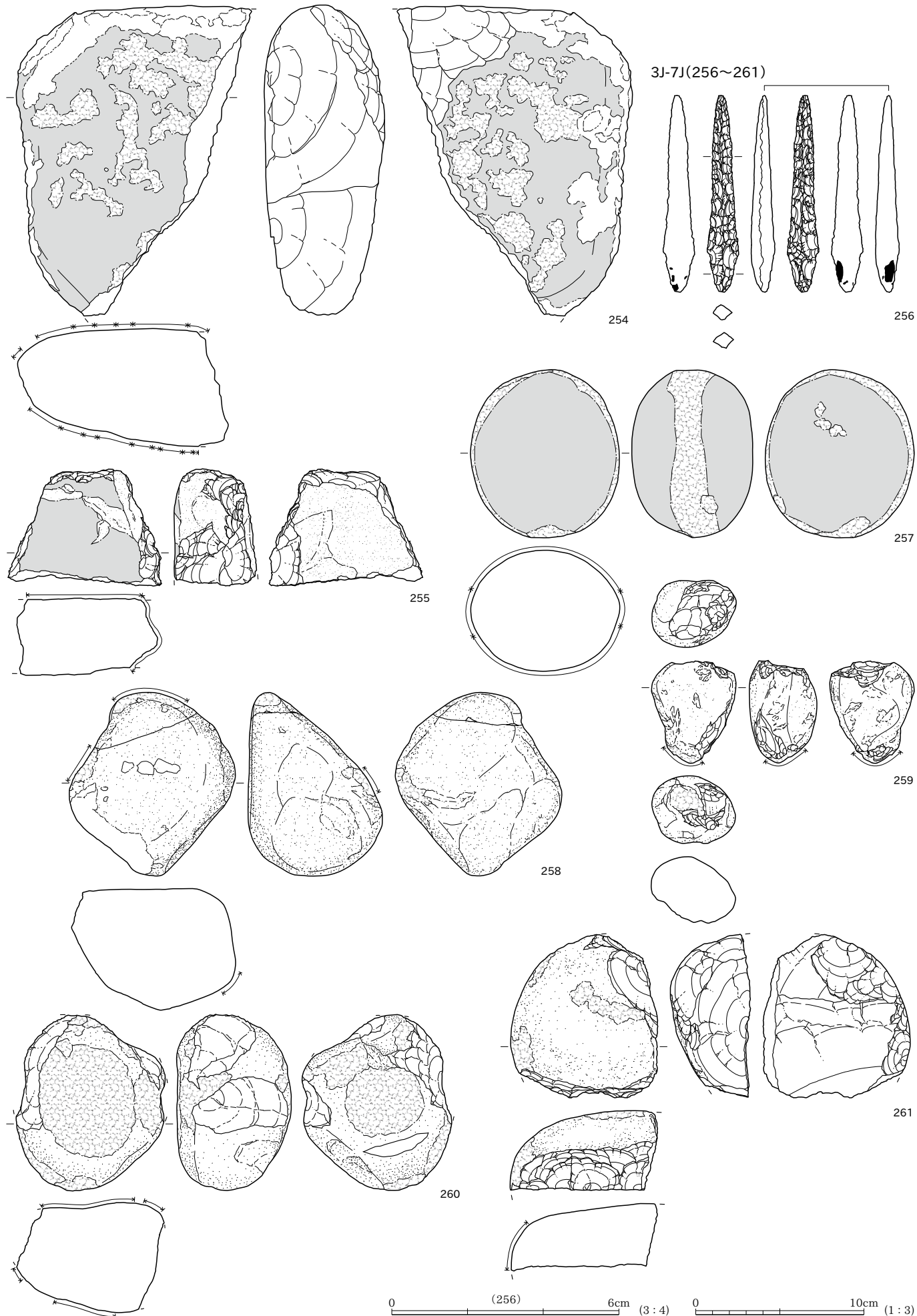

3J-7J(262~264)

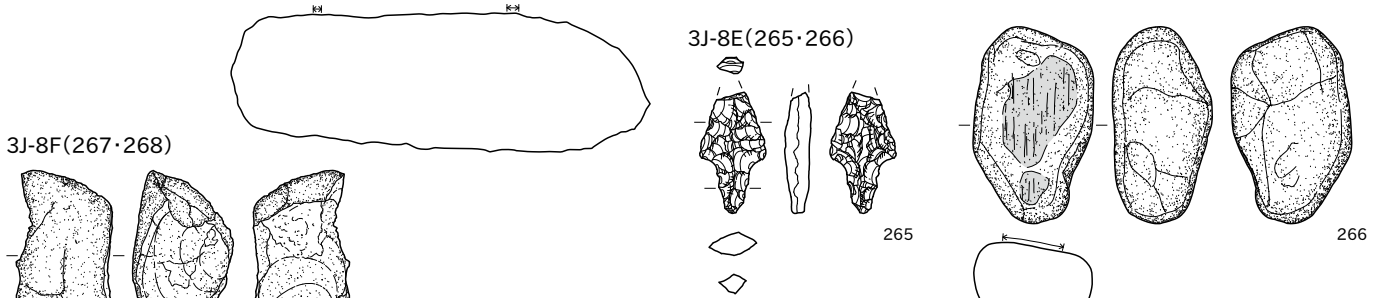
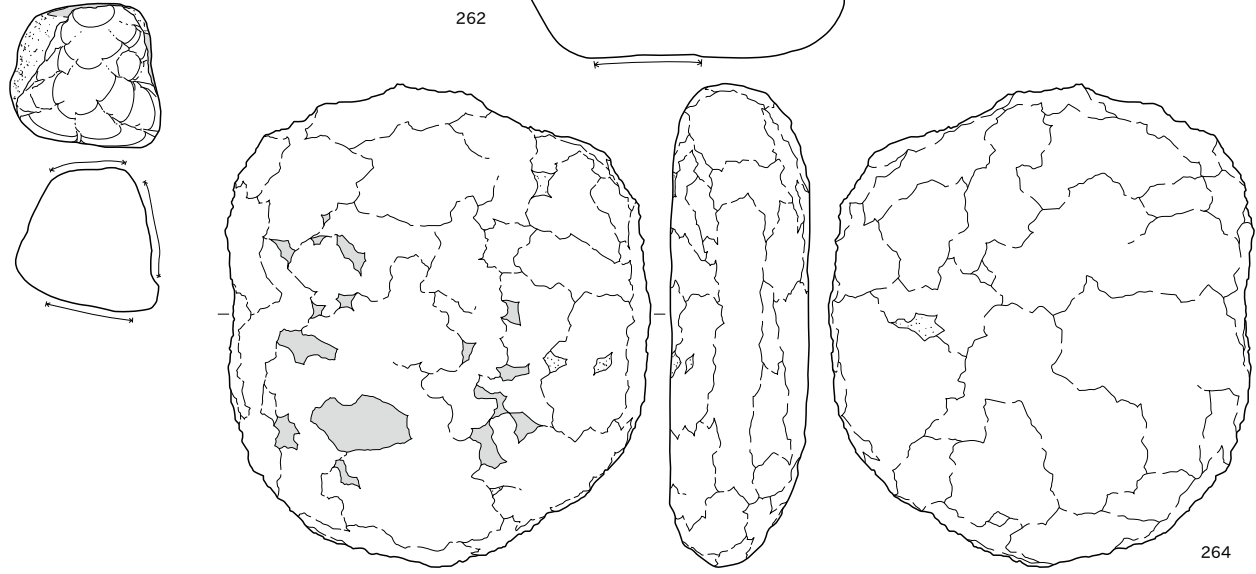
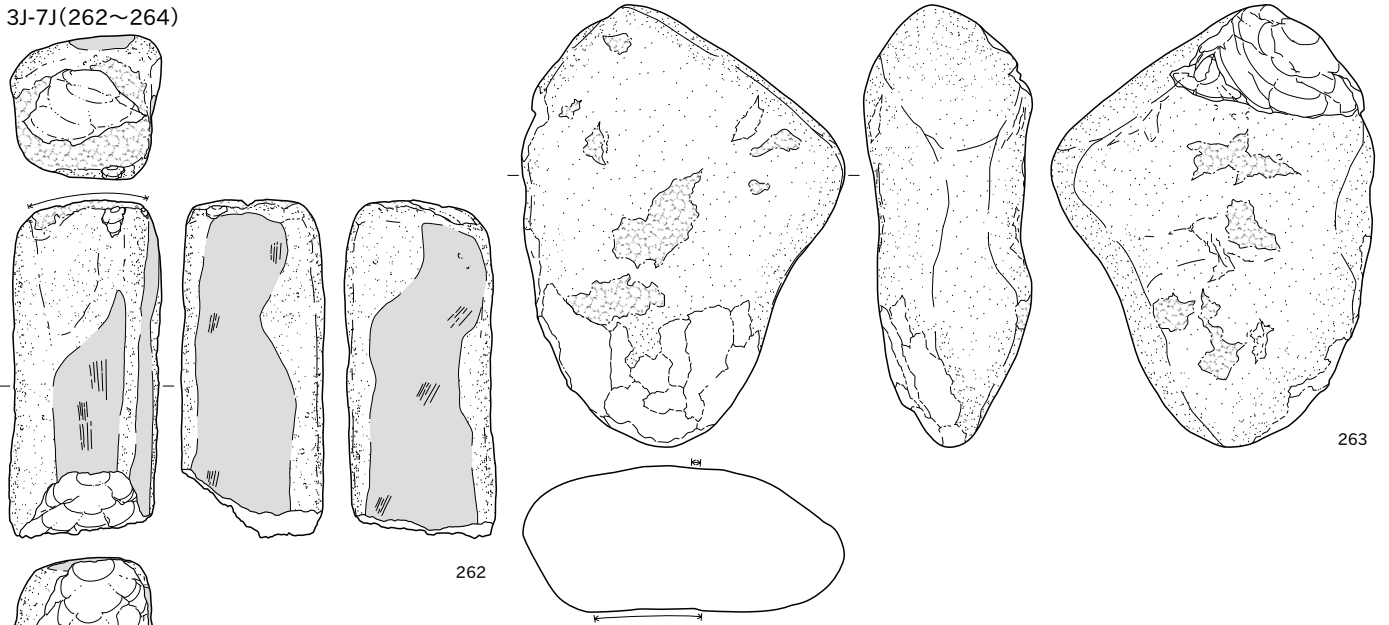

3J-8F(267・268)

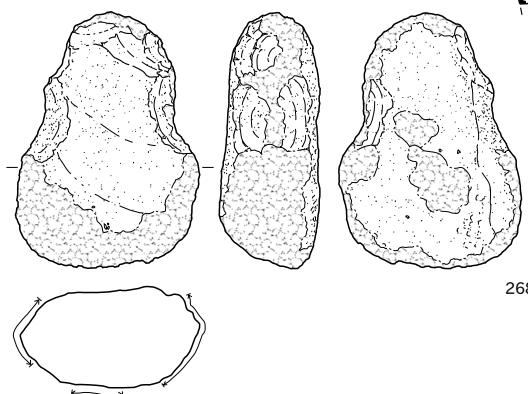
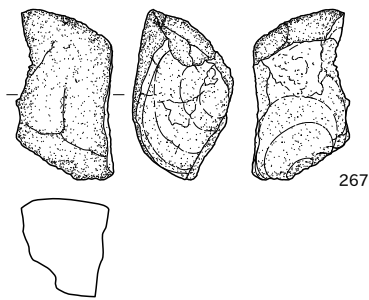

3J-8G(269~271)

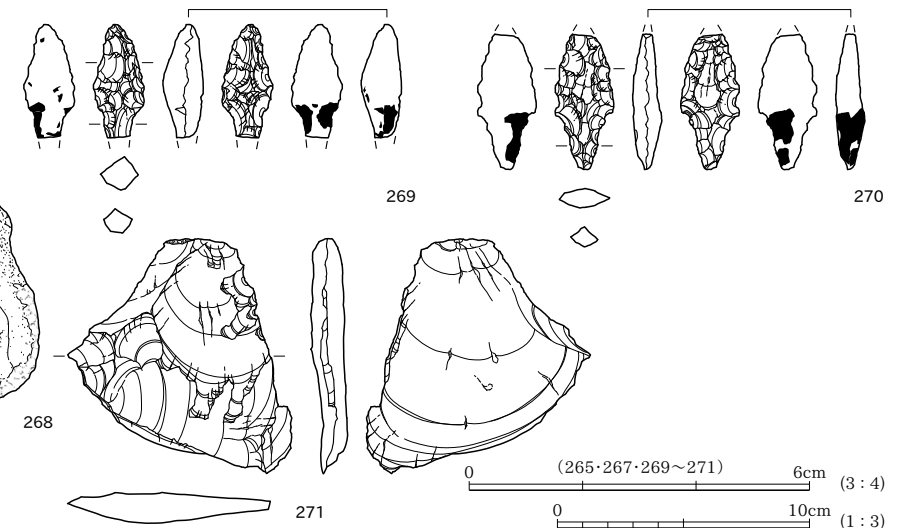

3J-8G(272~276)

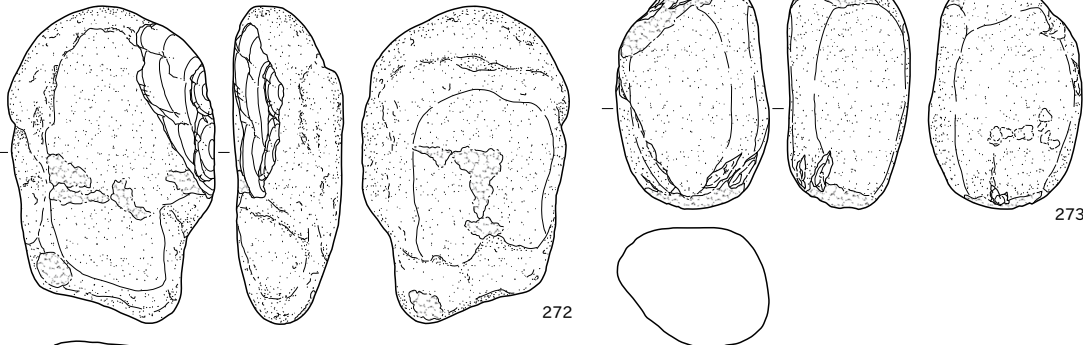

272

273

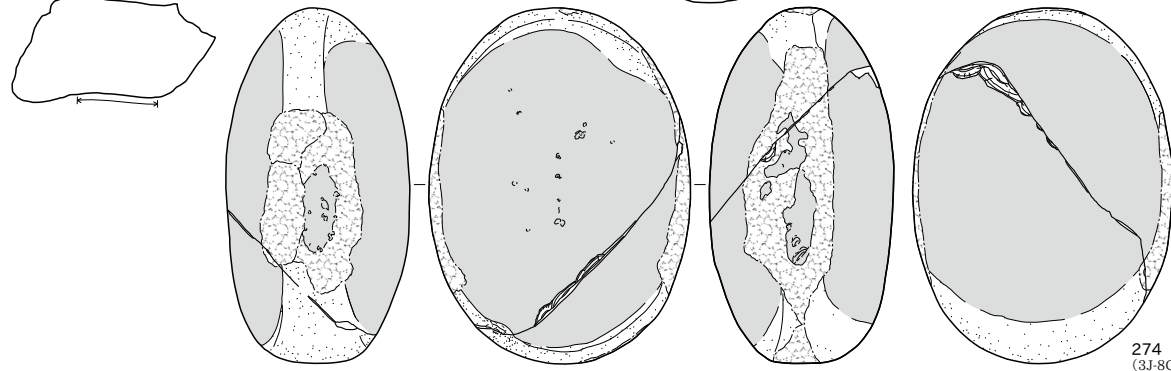

274
(3J-8G+3J-7J)

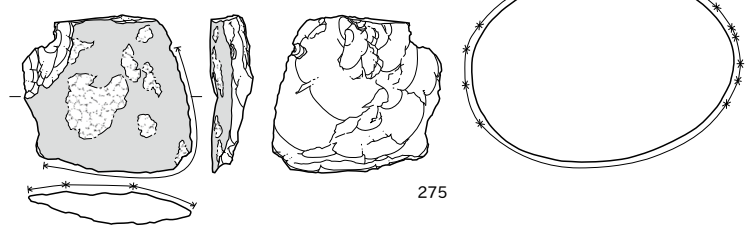

275

3J-8H(277~282)

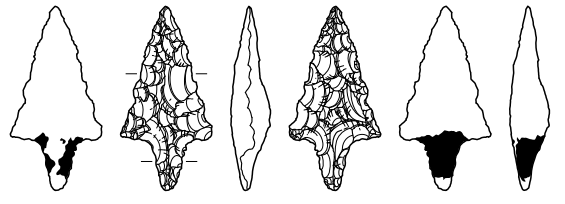

277

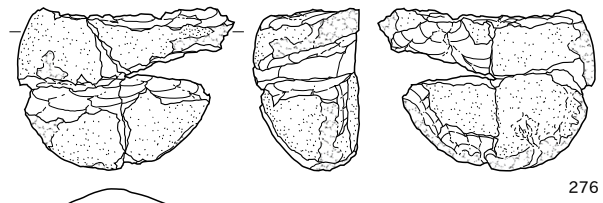

276

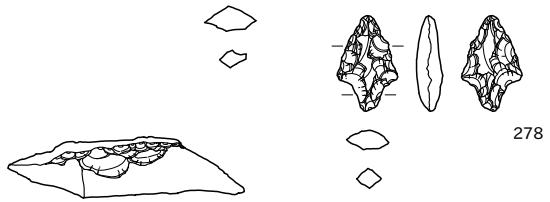

278

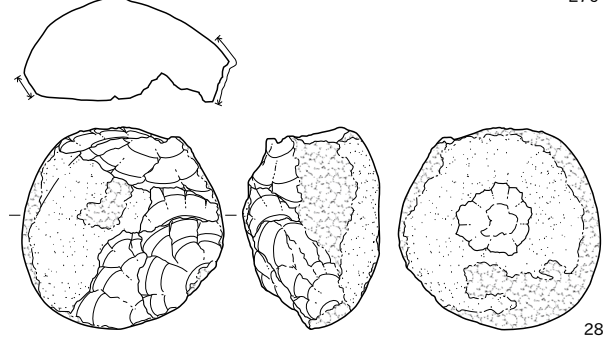

280

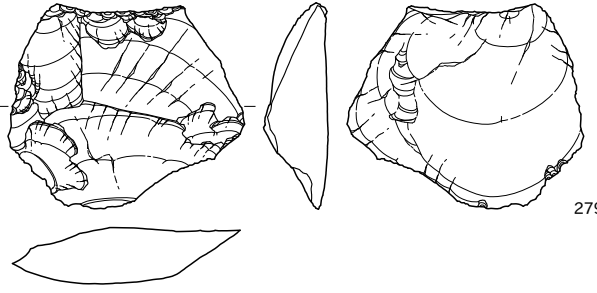

279

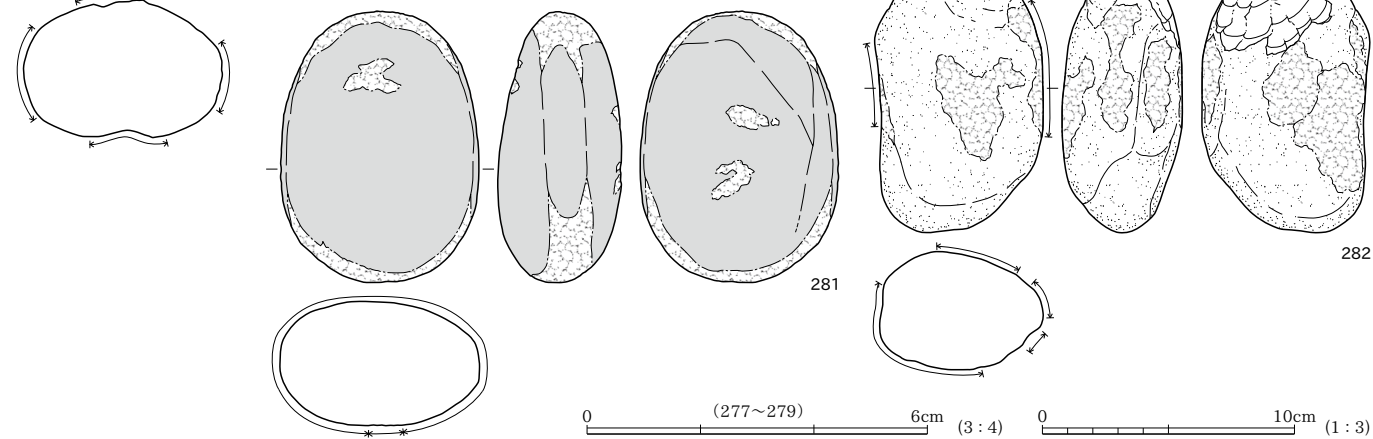

281

282

3J-8H(283~286)

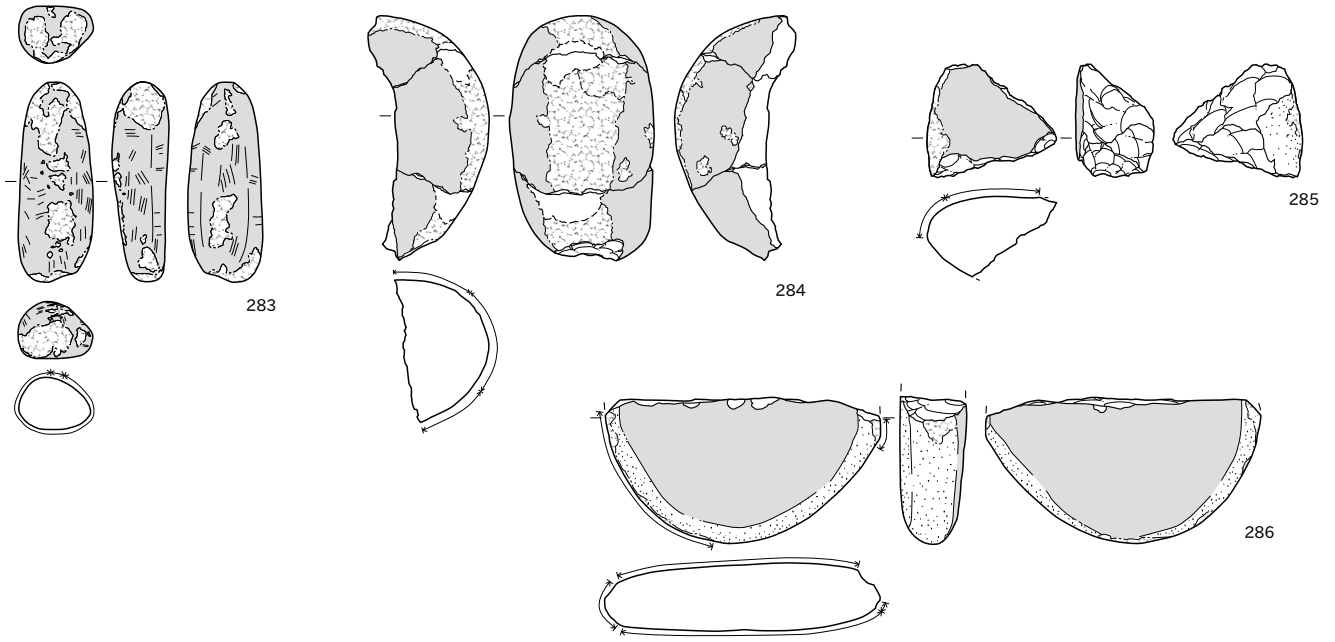

3J-8I(287~289)

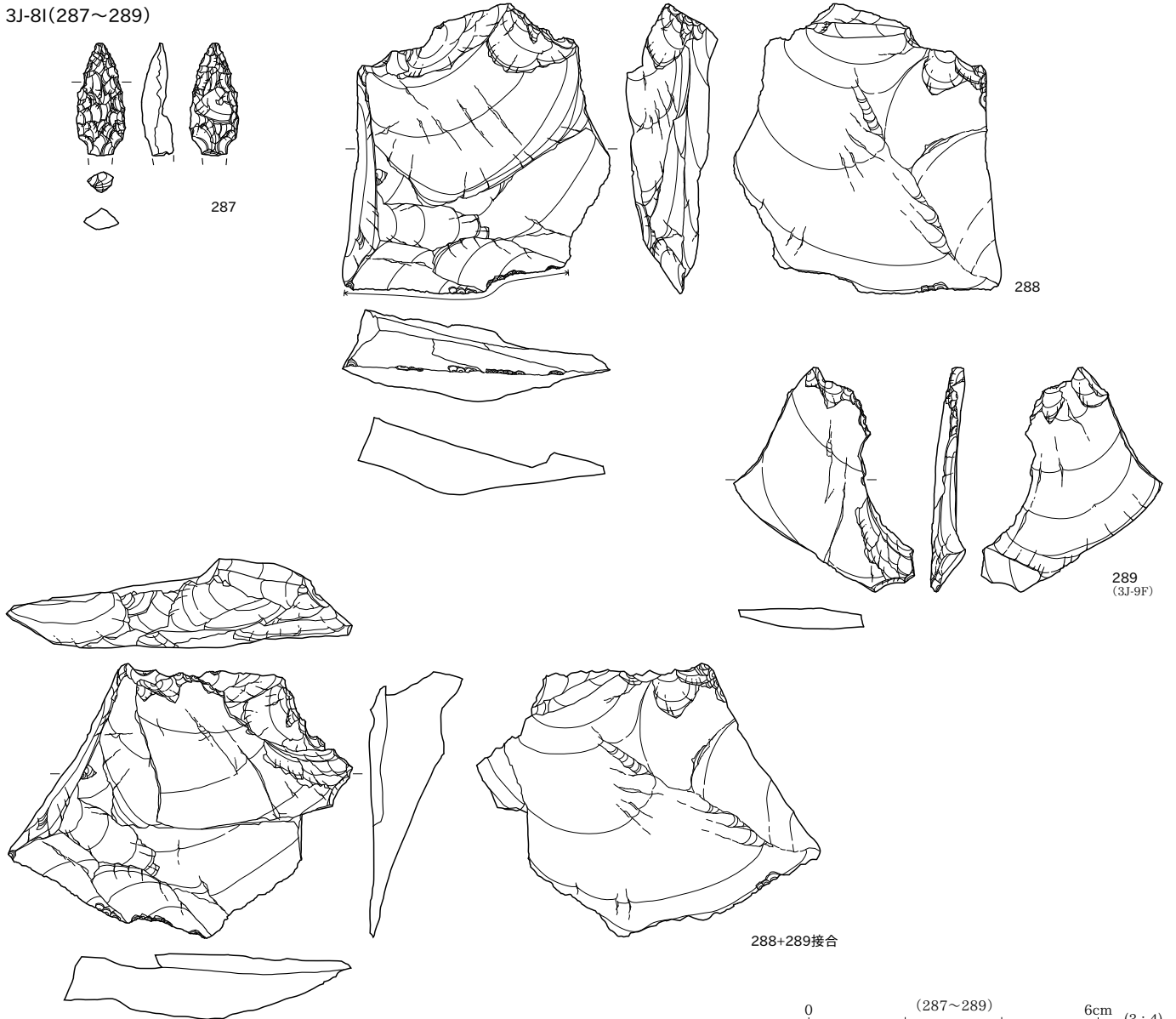

0 (287~289) 6cm (3:4)
 0 10cm (1:3)

3J-8I(290~292)

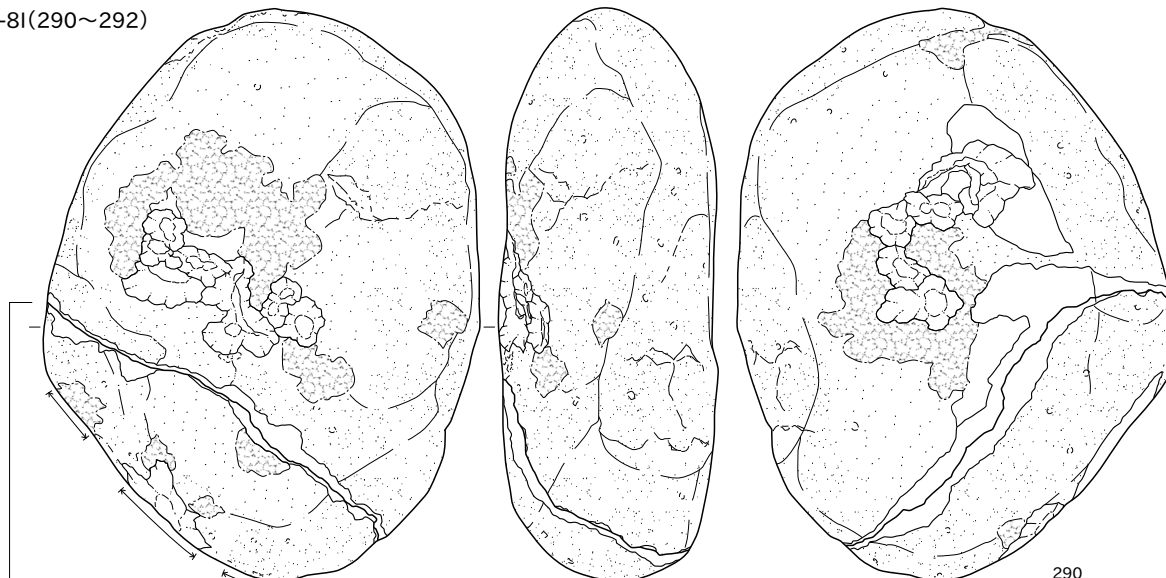

290
(3J-8I+3J-4H)

291

292

3J-8J(293)

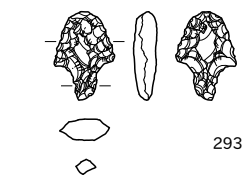

293

3J-9D(294)

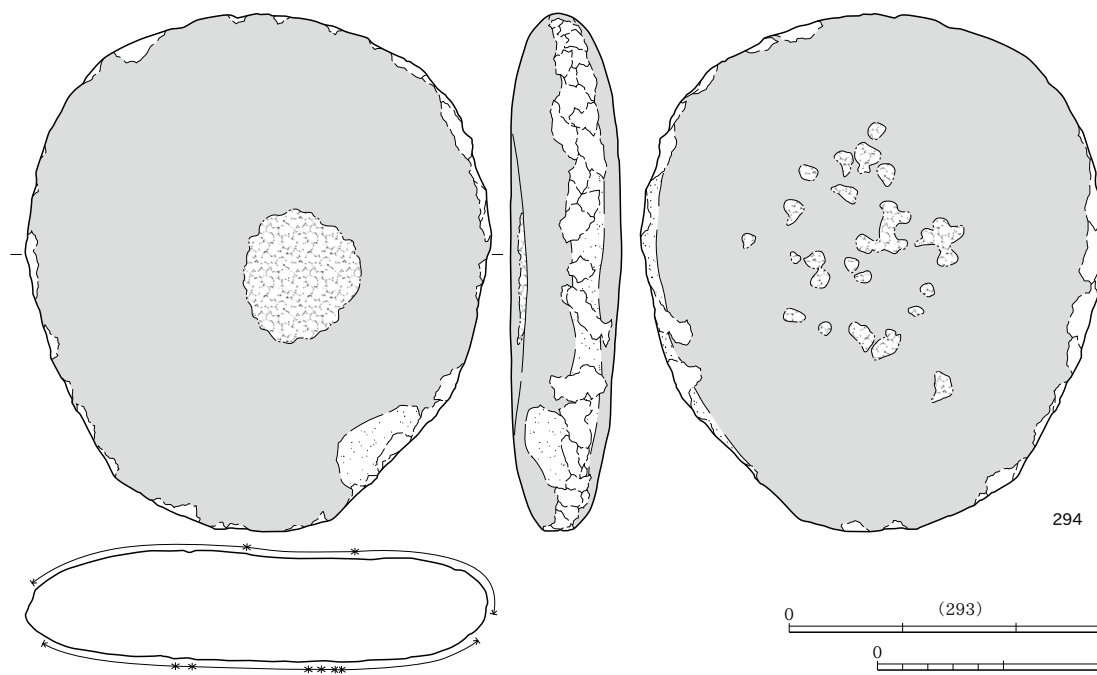

294

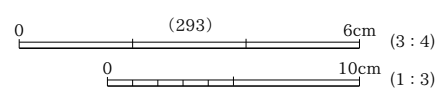

3J-9D(295)

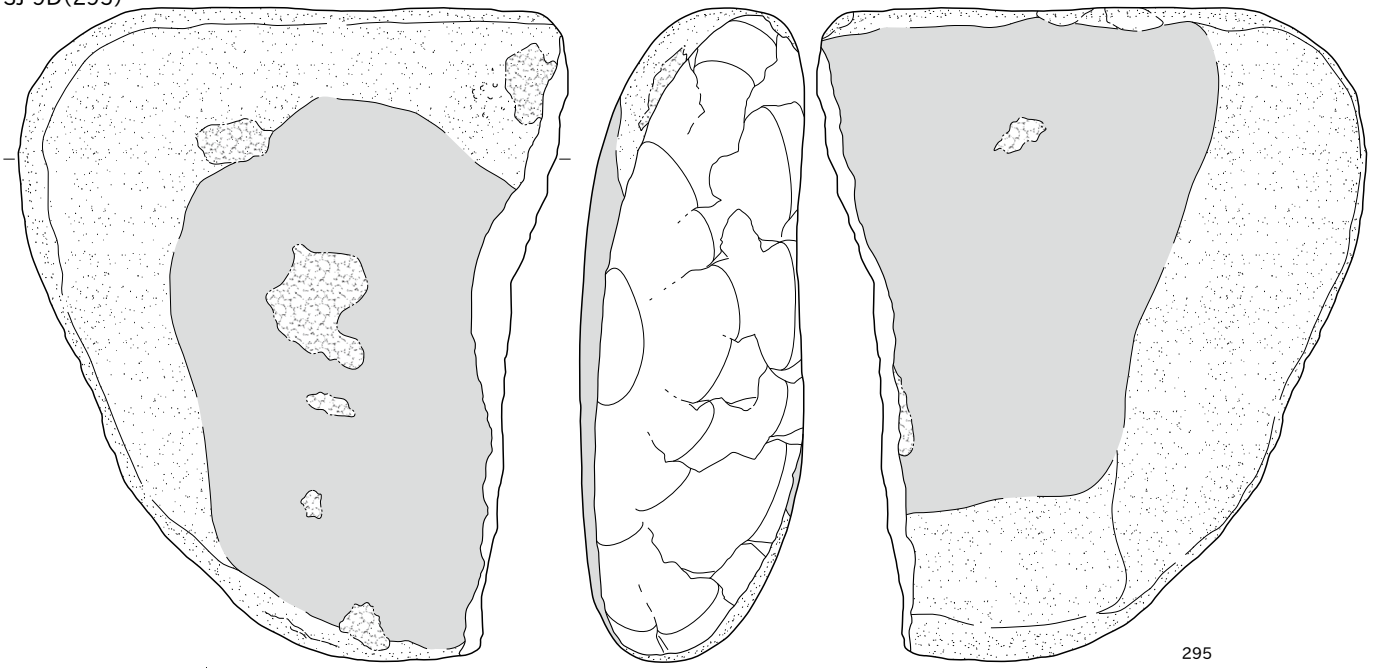

295

3J-9G(296~298)

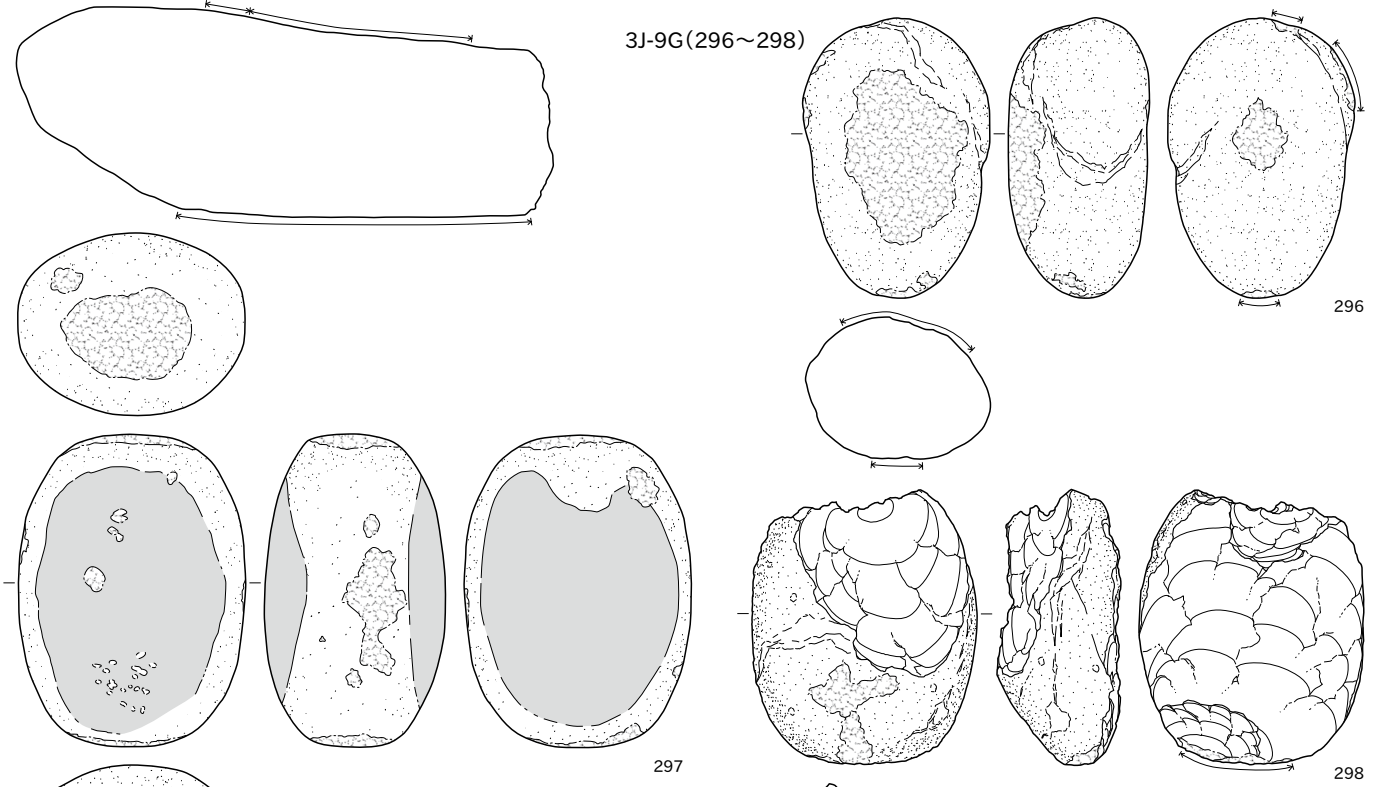

296

297

298

3J-9H (299)

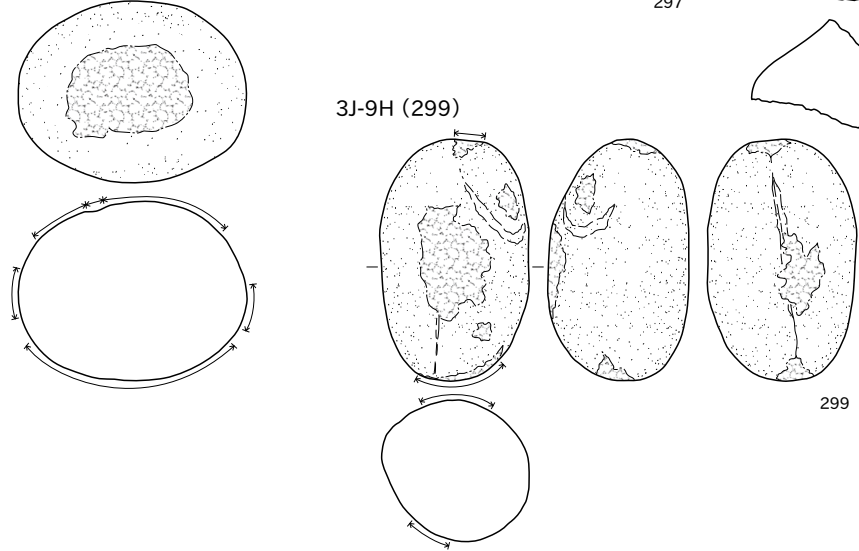

299

3J-9H (300)

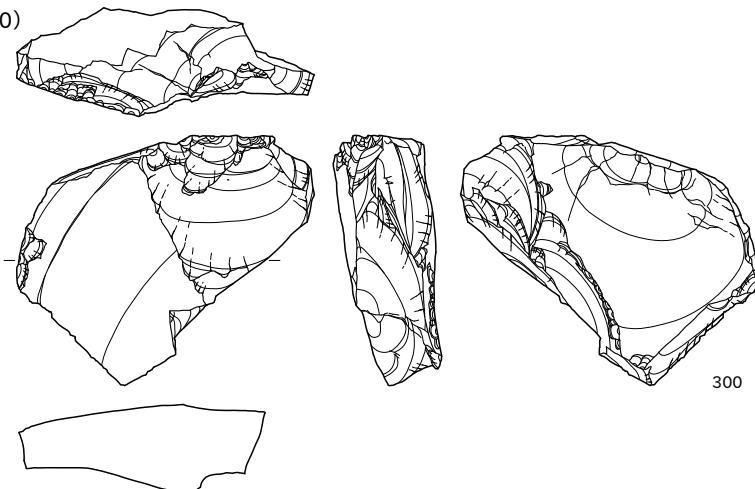

300

3J-9I (301)

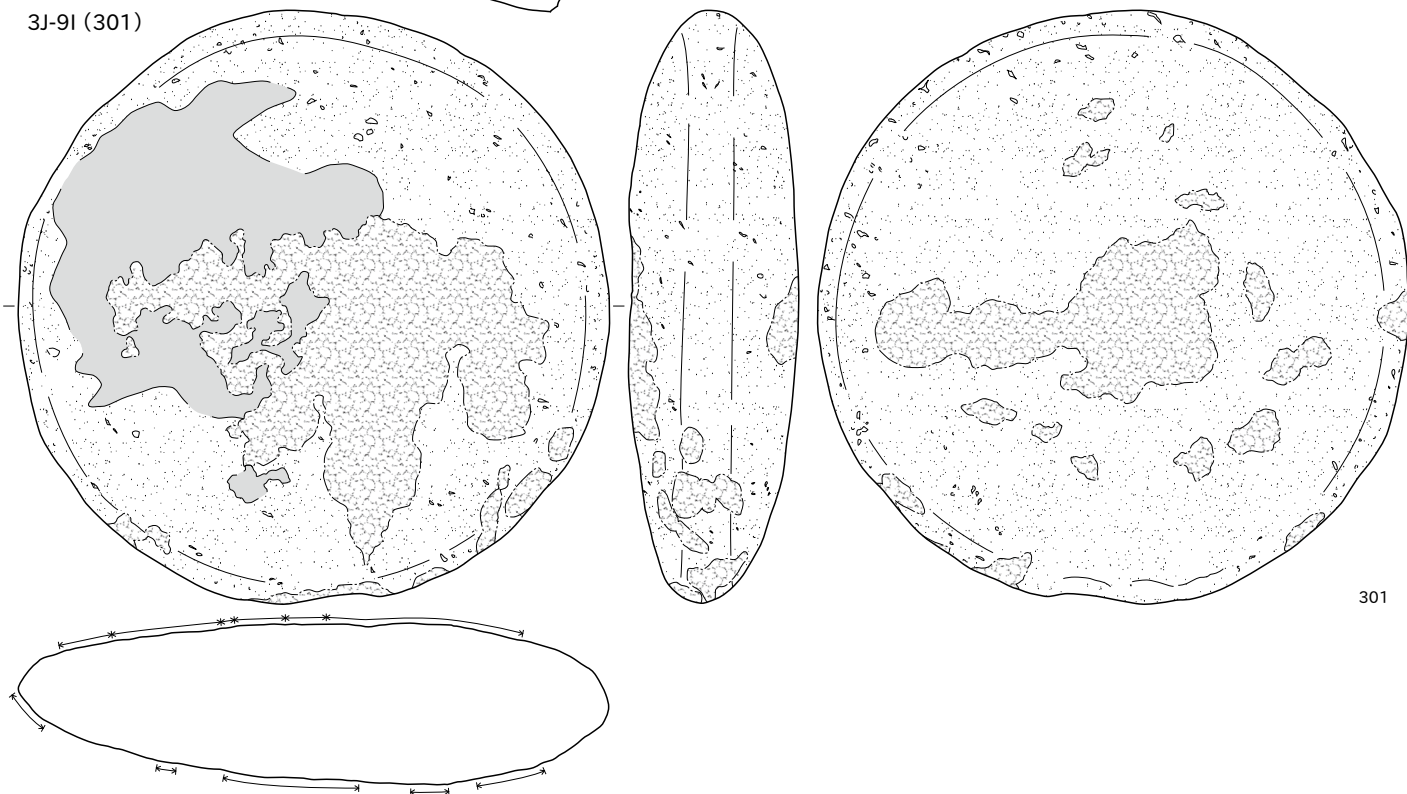

301

3J-10D(302)

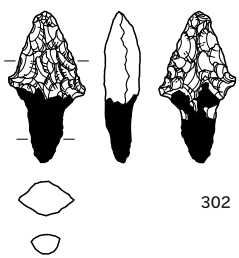

302

3J-10F(304)

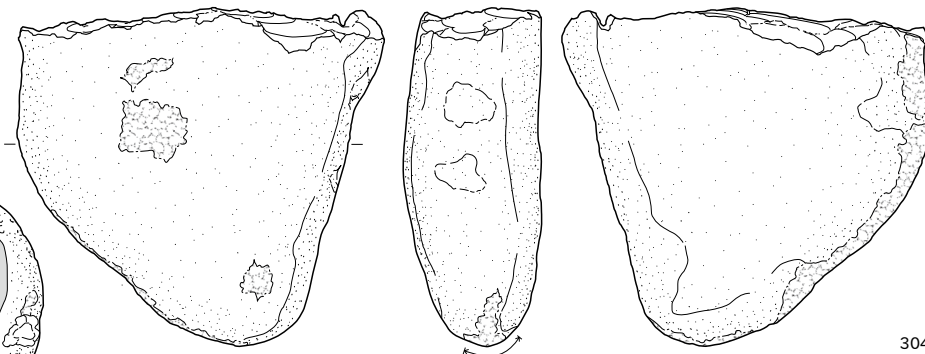

304

3J-10E(303)

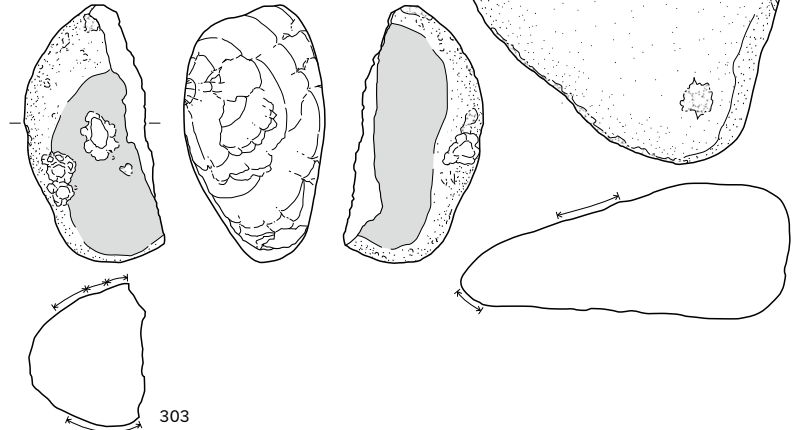

303

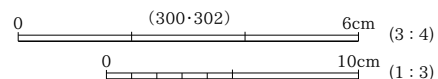

3J-10G(305)

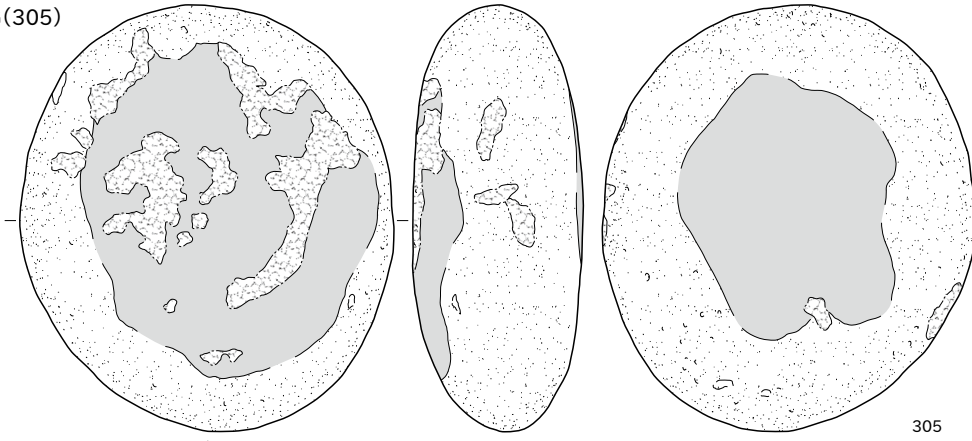

305

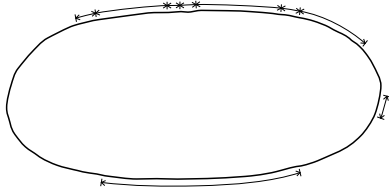

3J-10H(306)

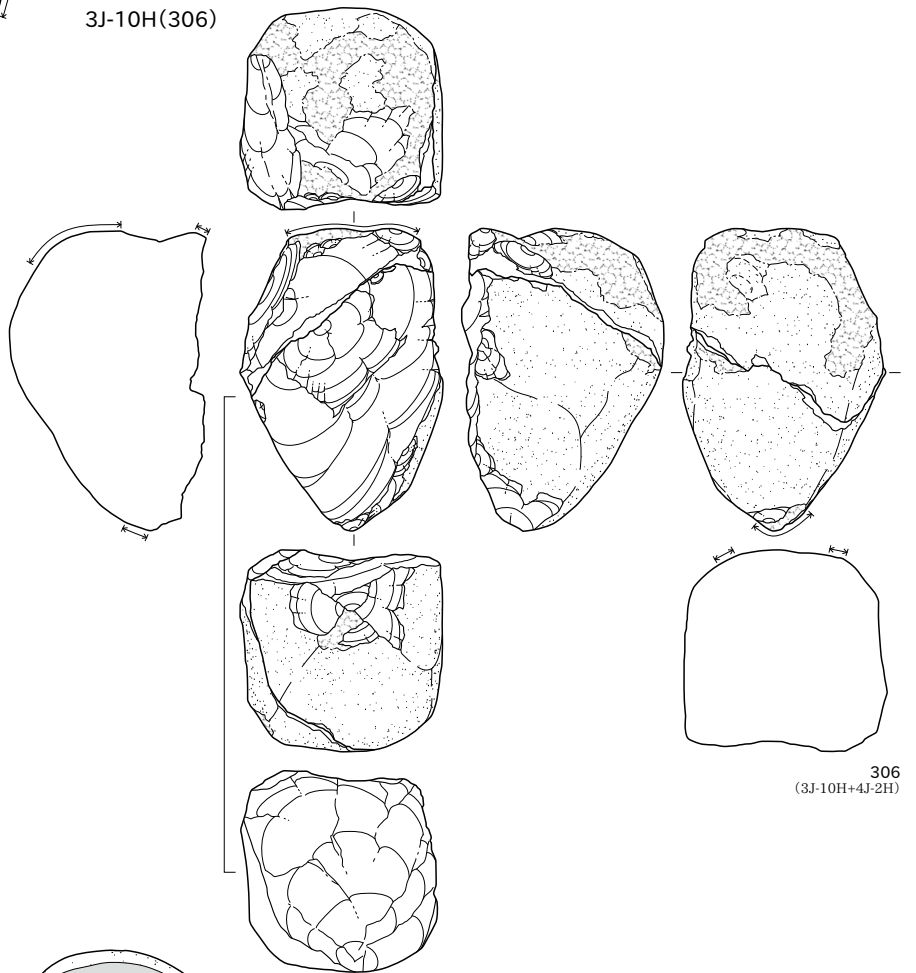

306
(3J-10H+4J-2H)

3J-10H·10I(307)

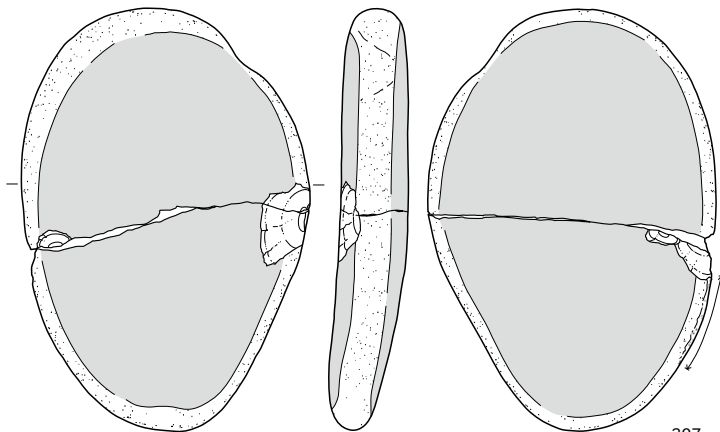

307
(3J-10H+3J-10I)



0 10cm (1:3)

3J-10I(308)

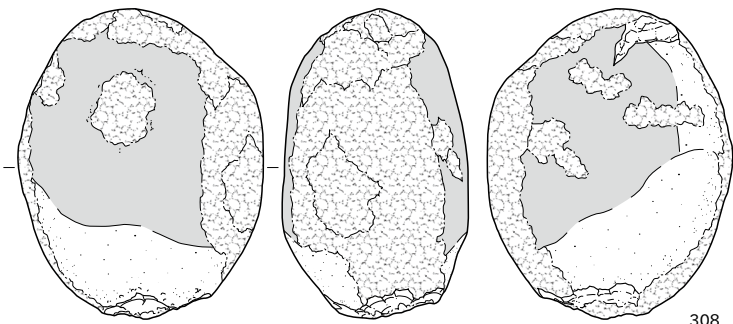

308

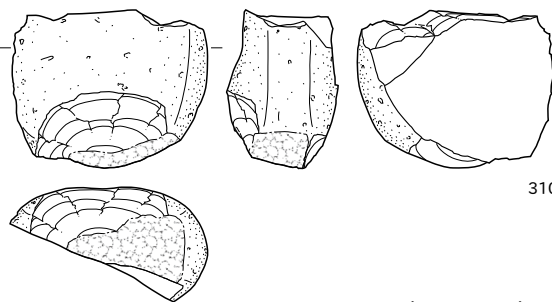

310

4J-1C(309-310)

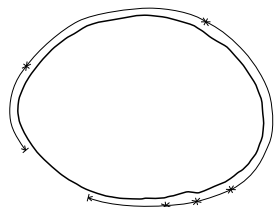

309

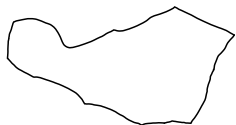

4J-1D(311~314)

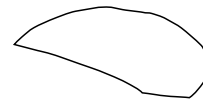

311

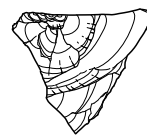
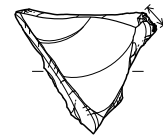

312

4J-1E(315-316)

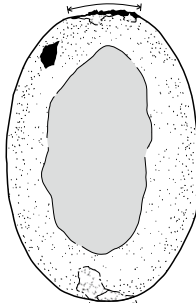
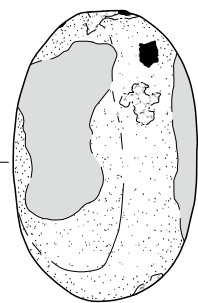
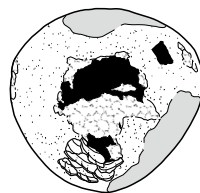

313

315

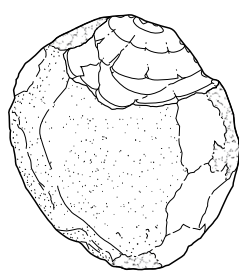
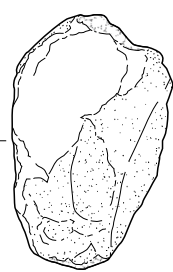
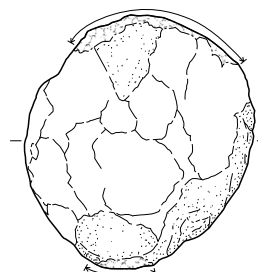
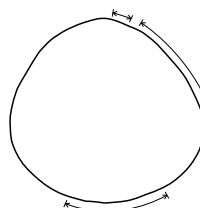
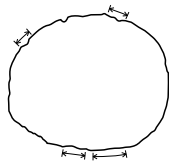
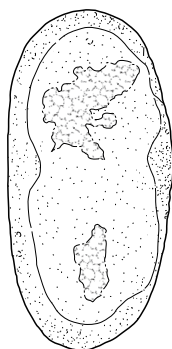
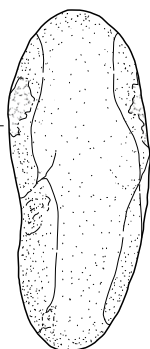
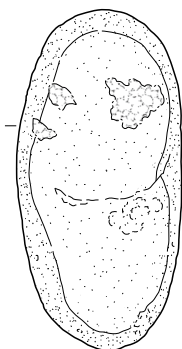

314

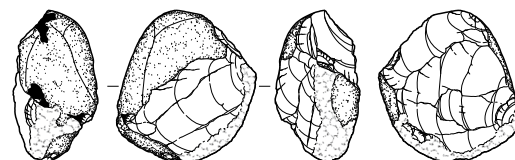

316

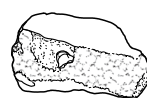

4J-1E(317・318)

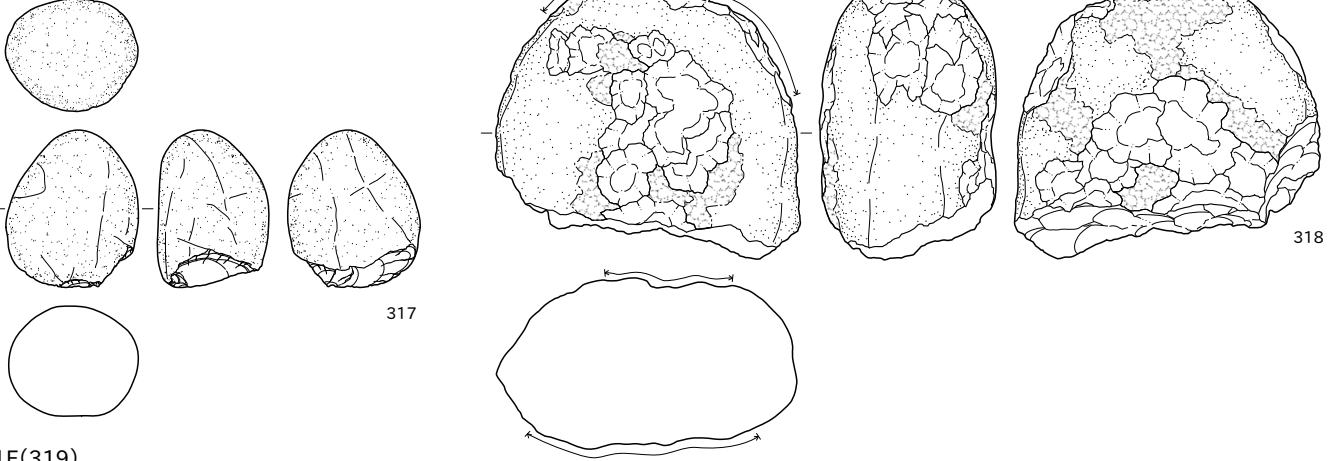

4J-1F(319)

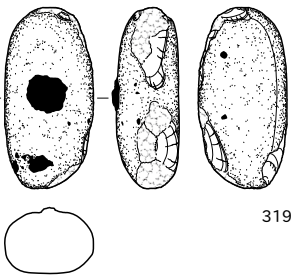

4J-1G(320~322)

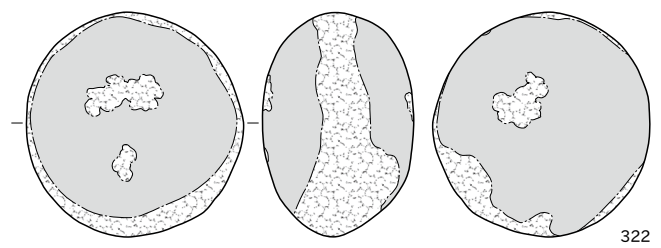
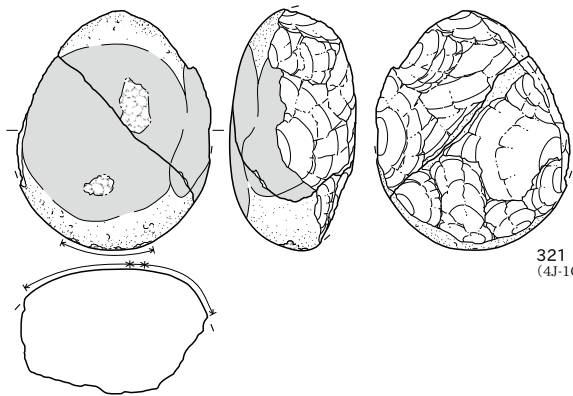
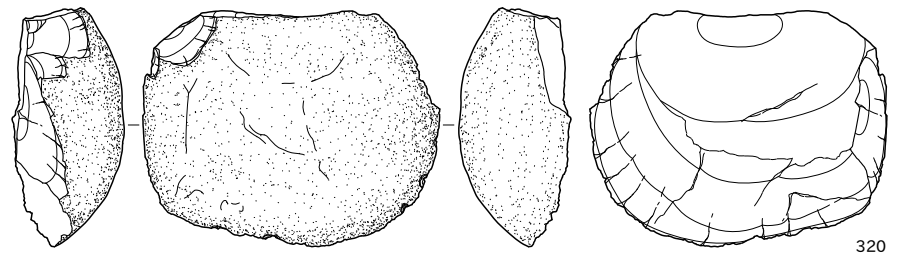

4J-2D(323)

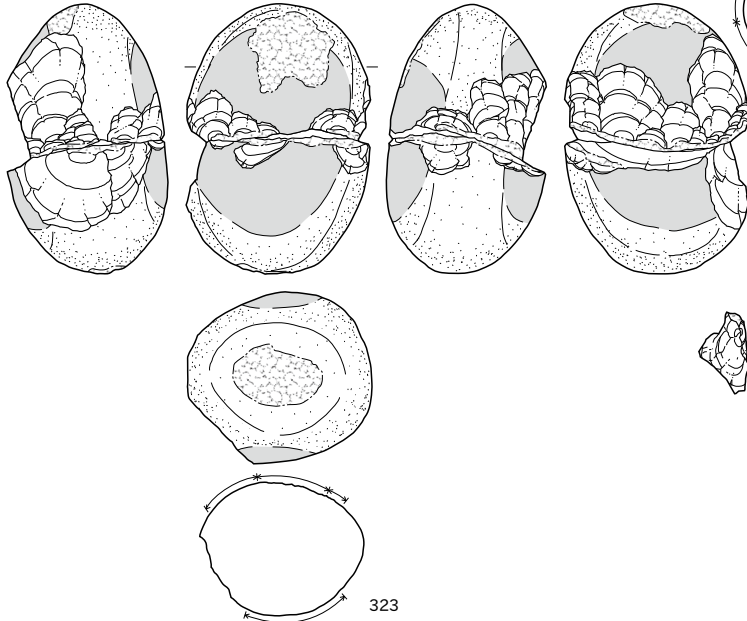

4J-2E・2G(324)

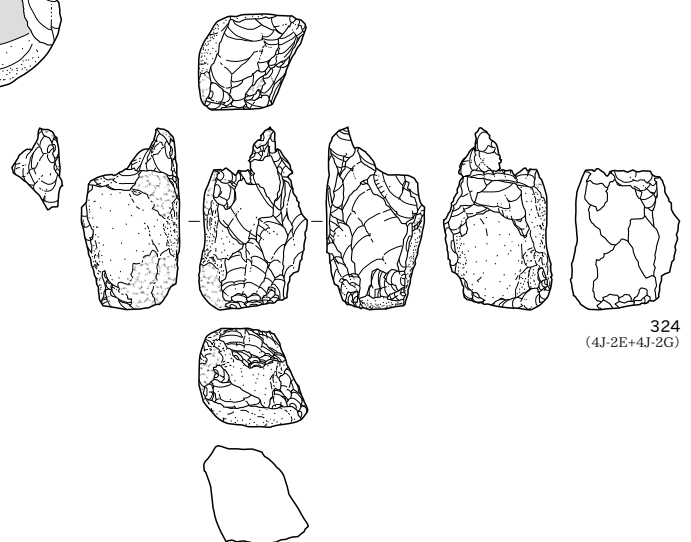

0 (320) 6cm (3 : 4)
 0 10cm (1 : 3)

4J-2E(325~328)

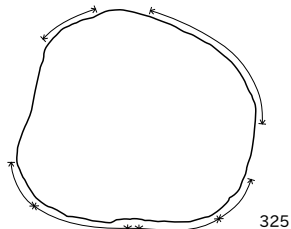
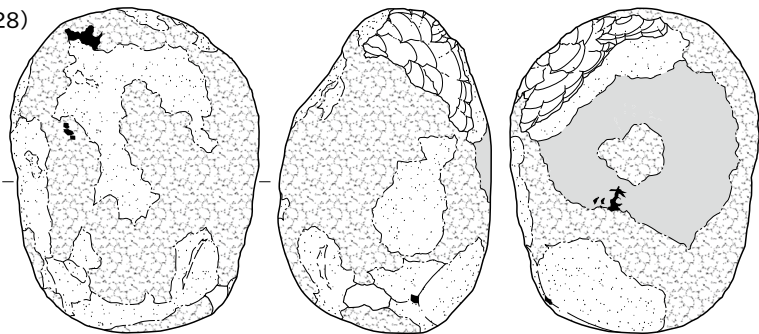

325

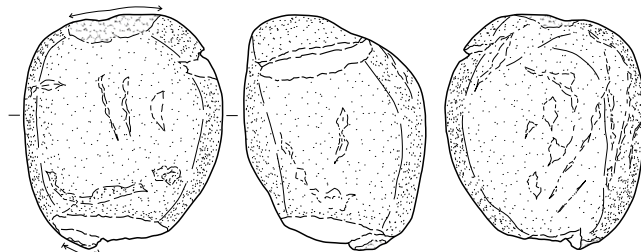

326

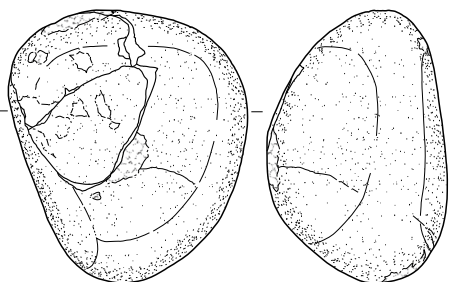

327

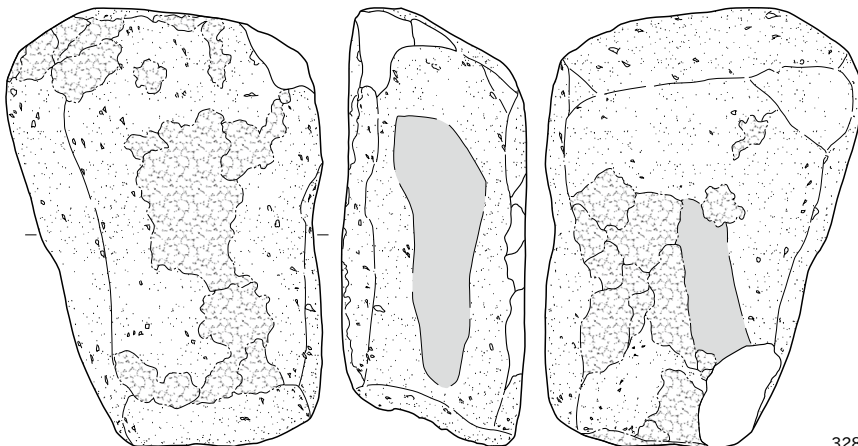
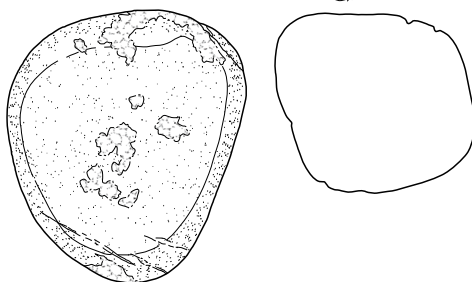

328

4J-2F(329・330)

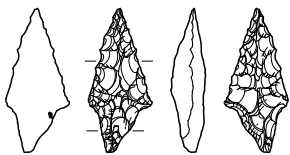

329

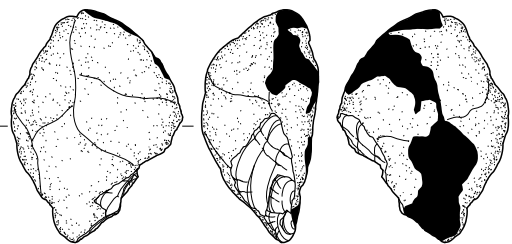

330

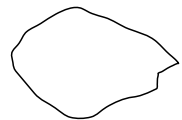

4J-2G(331)

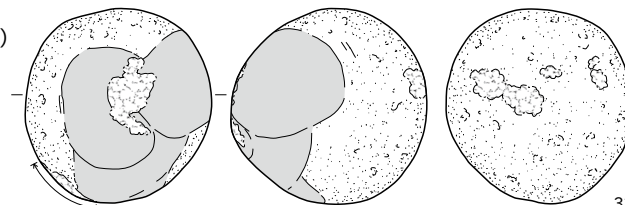

331

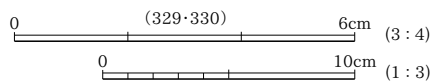
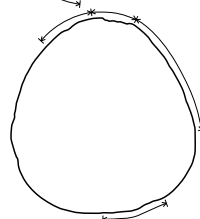

4J-2G(332)

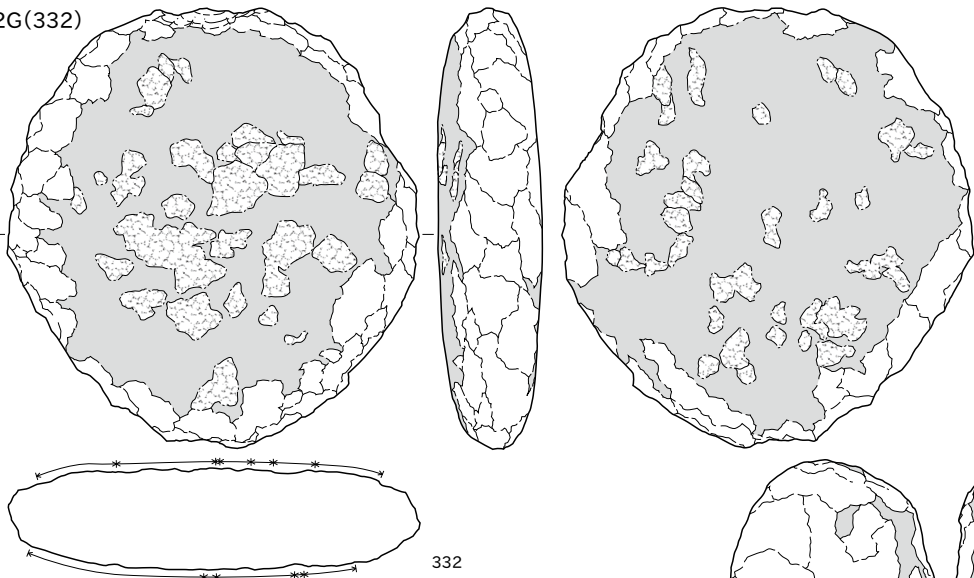

332

4J-3F(333~335)

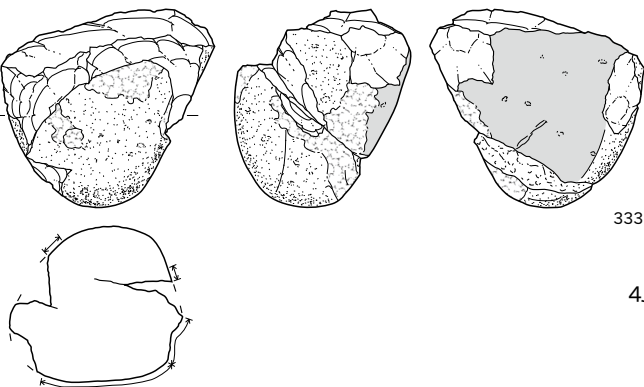

333

334

4J-3G(336~337)

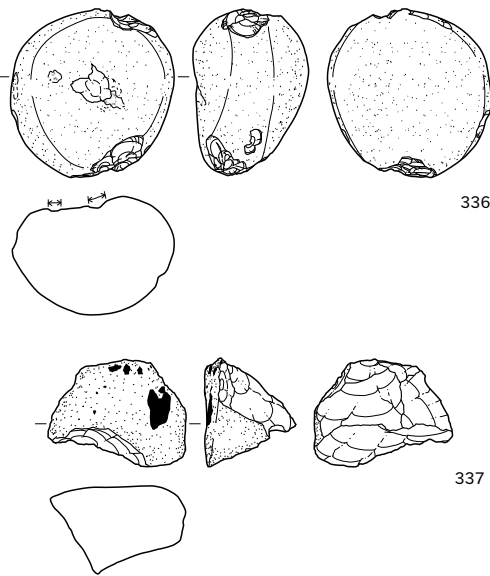

336

337

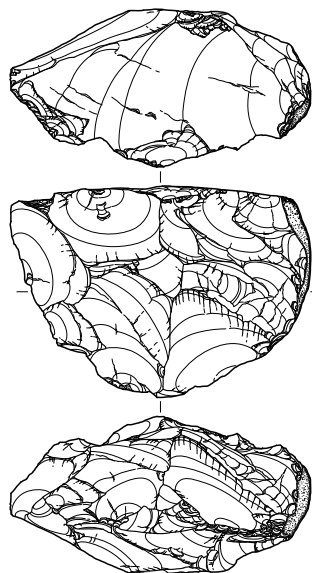

335

4J-4D(338)

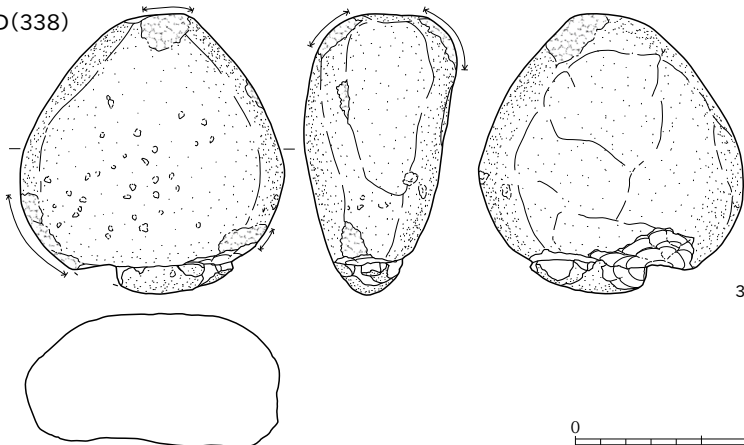

338

4J-4F(339・340)

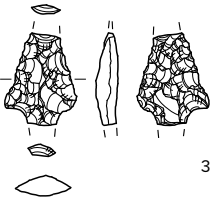

339

4J-4G(341・342)

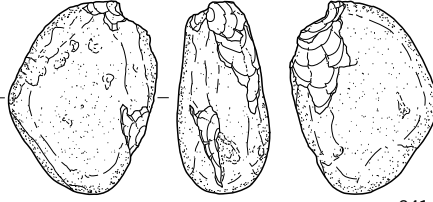

341

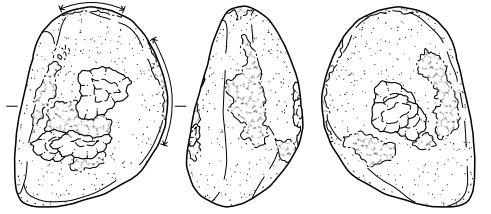

342

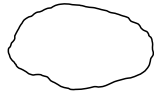

上層出土・攪乱(343~356)

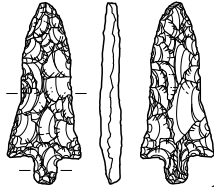

343
(II~IV層)

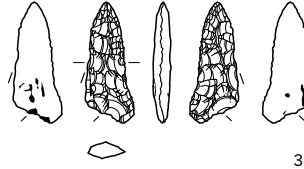

344
(河138)

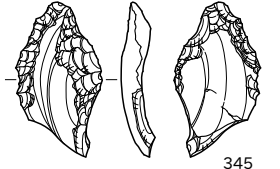

345
(河138)

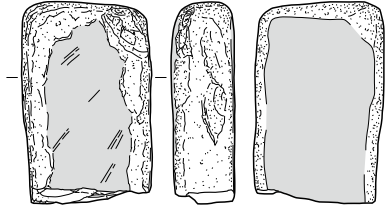

340



346
(SD153)

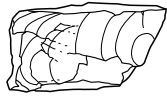

347
(上層一括)

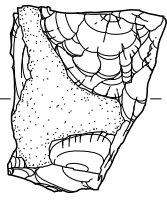

348
(上層一括)

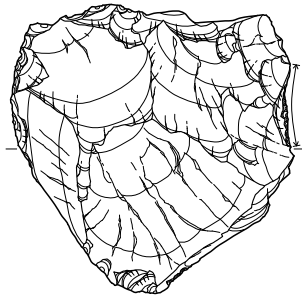

349
(攪乱)

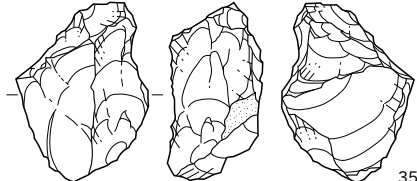

350
(攪乱)

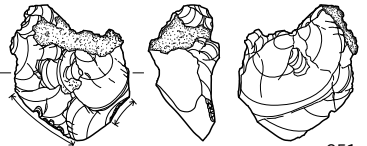

351
(攪乱)

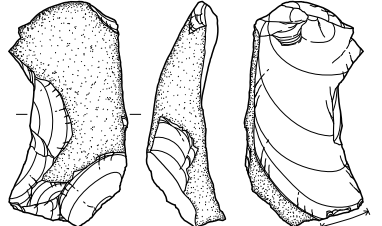

352
(河138)

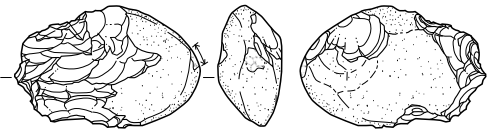

353
(攪乱)

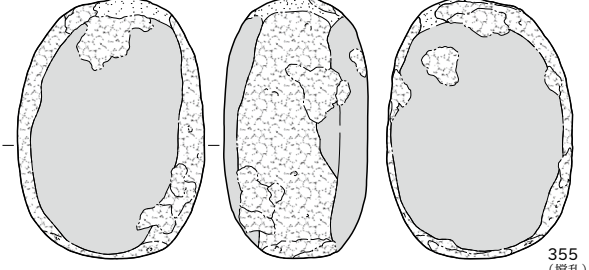

355
(攪乱)



354
(攪乱)

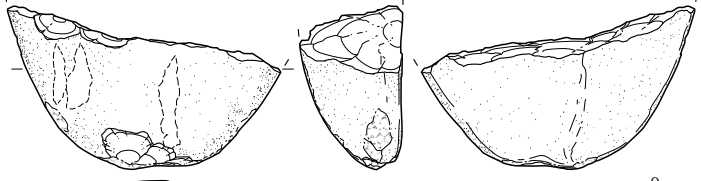

356
(攪乱)

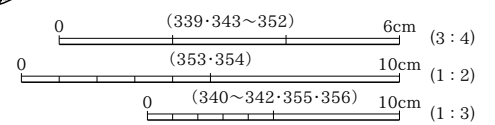

上層出土・攪乱(357~364)

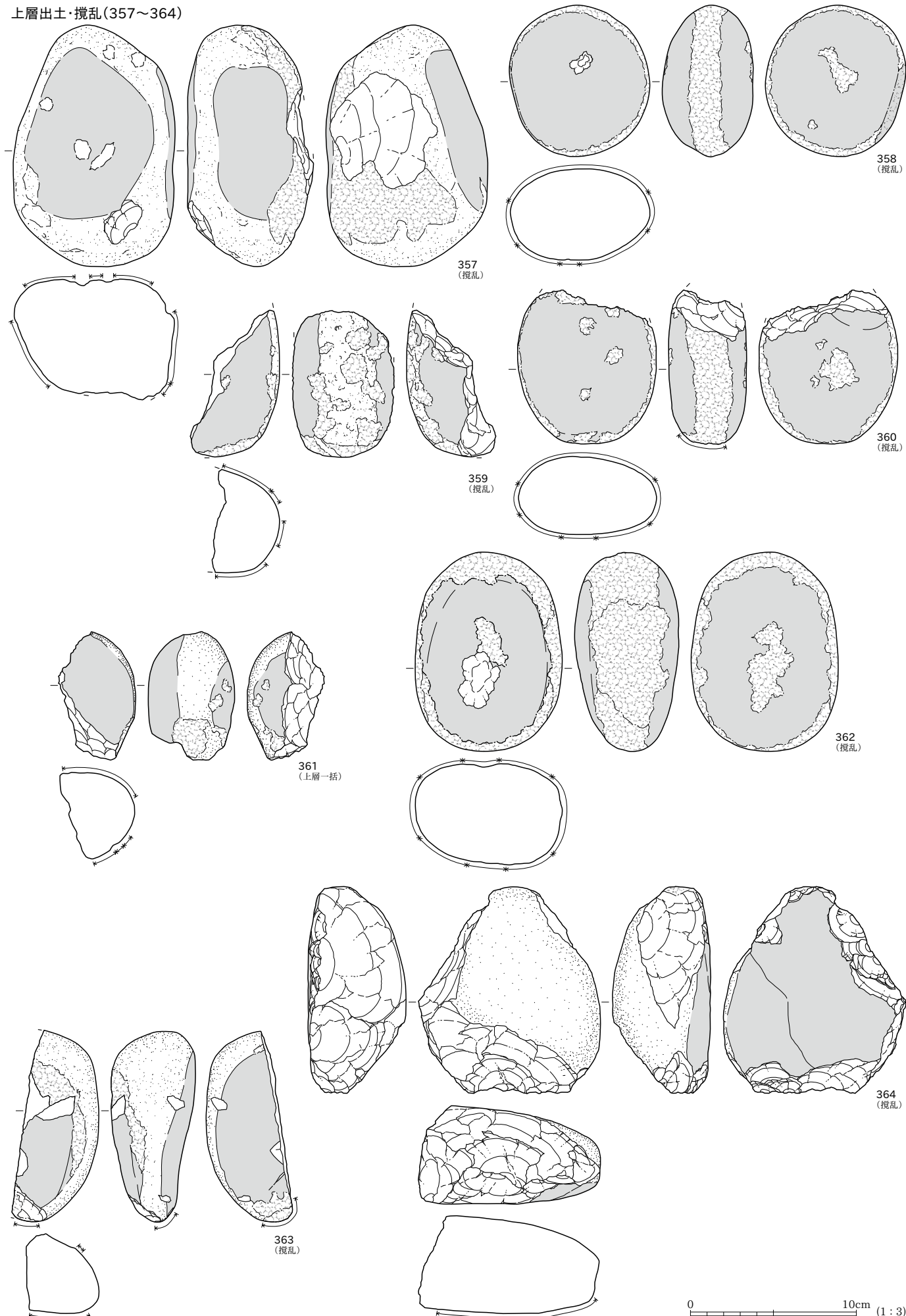

358 (攪乱)

357 (攪乱)

360 (攪乱)

359 (攪乱)

362 (攪乱)

361 (上層一括)

364 (攪乱)

363 (攪乱)

上層出土・攪乱(365~367)

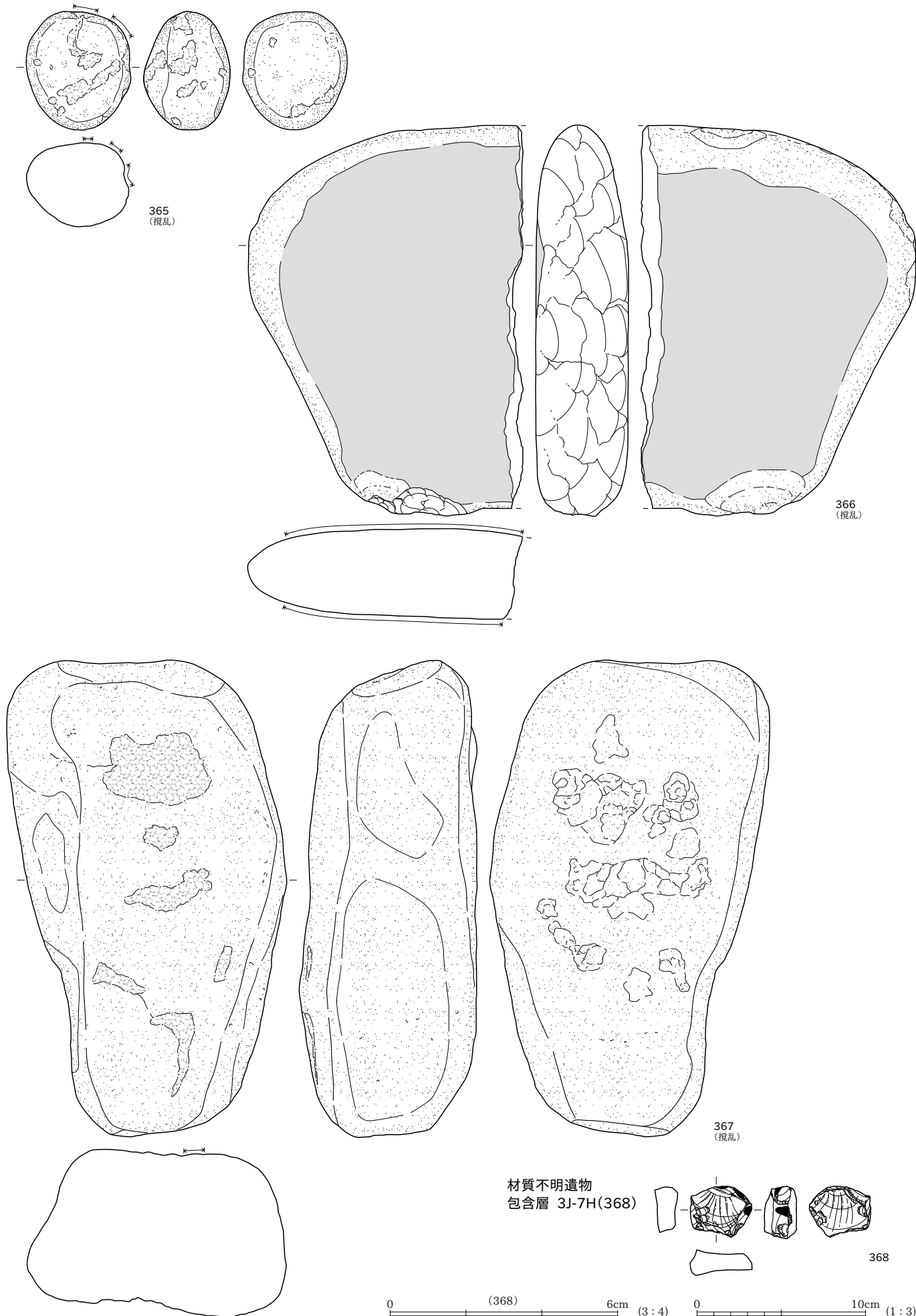

SD153(1・2)

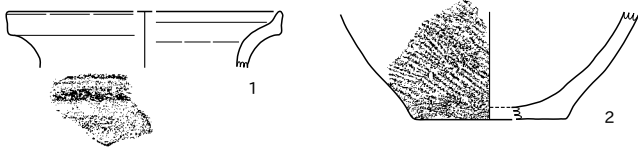

SD157(3)

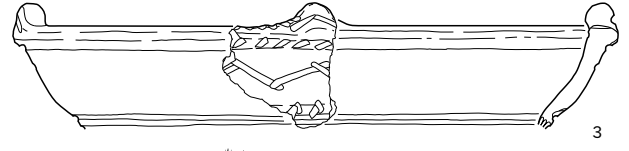

包含層 3K-1A(4)



3K-5A(5)

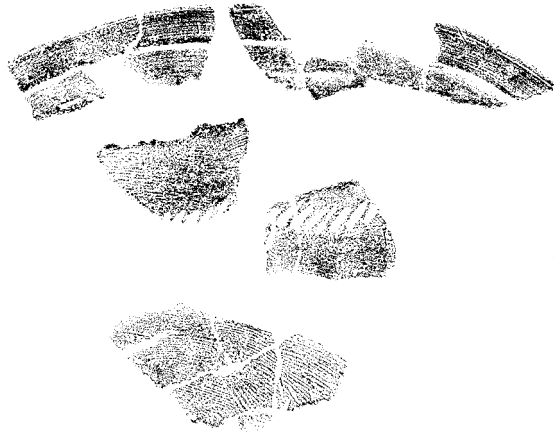
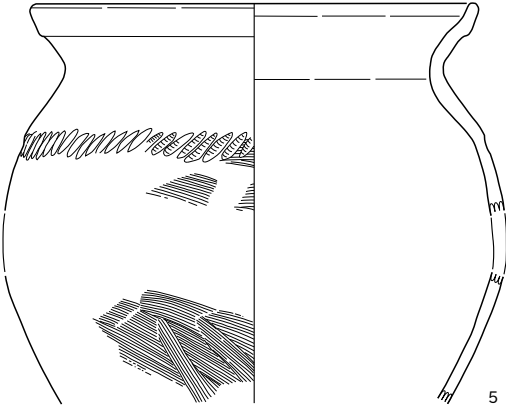

4J-3B(6)

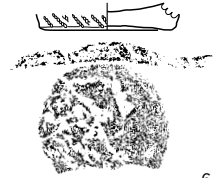

古墳時代

SD153(7)

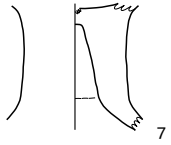

SD155(8)

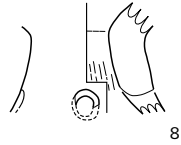

SX949(13)

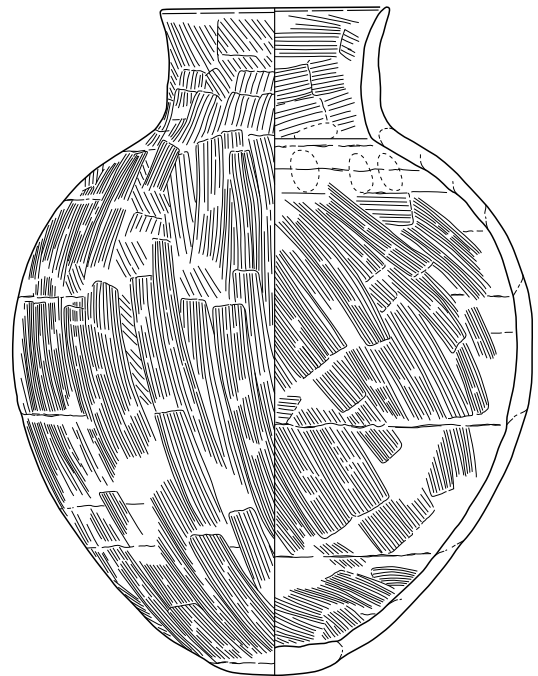

SD157(9)

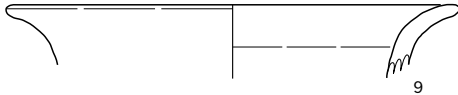

SE882(10)

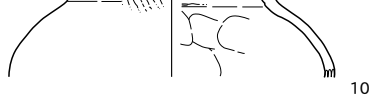

SX275(11)



SX227(12)

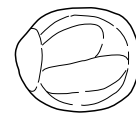
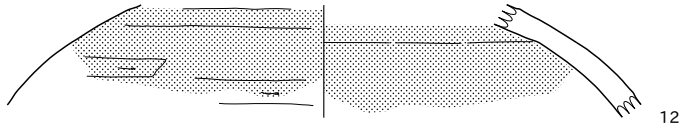

13

SX949(14)



SX948(15)

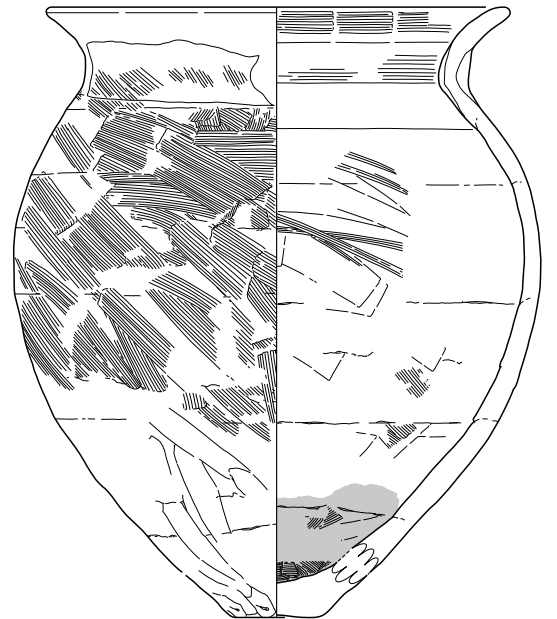

河138(16)



古代

SB1552P1(17)

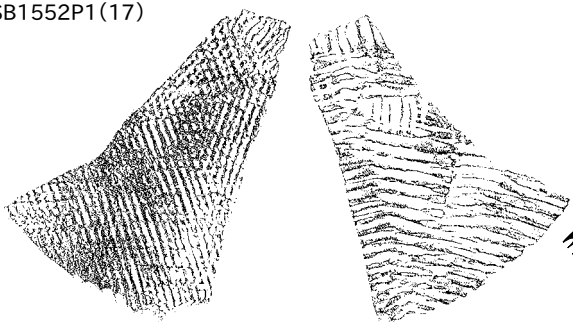

Pit46(18)

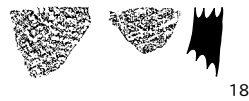

Pit72(19・20)



Pit539(22)

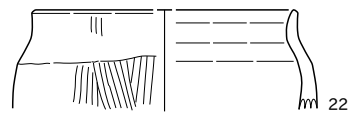

Pit618(21)



0 10cm (1:3)

Pit718(23)

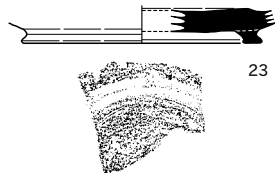

Pit1211(25)

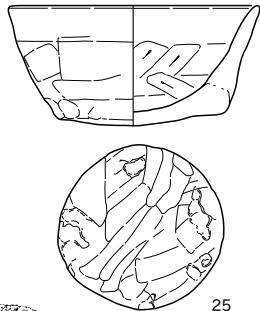

SD153(26~29)

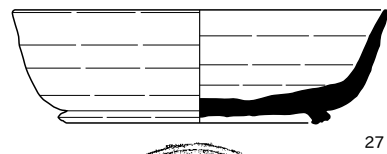
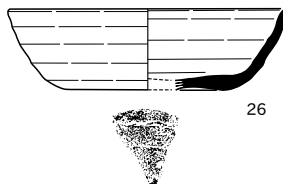

Pit1289(24)

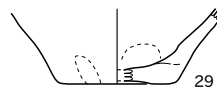
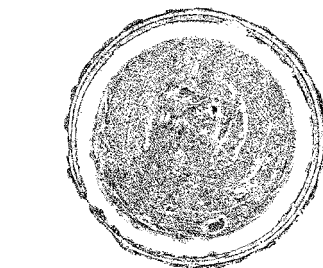
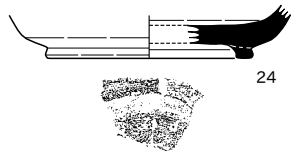

SD76(30)



SD232(31)



SD157(32~44)

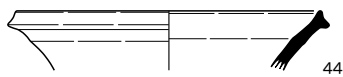
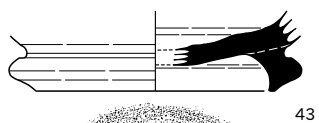
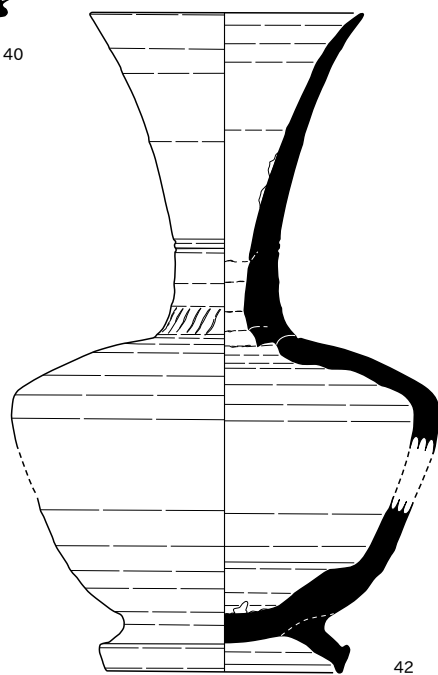
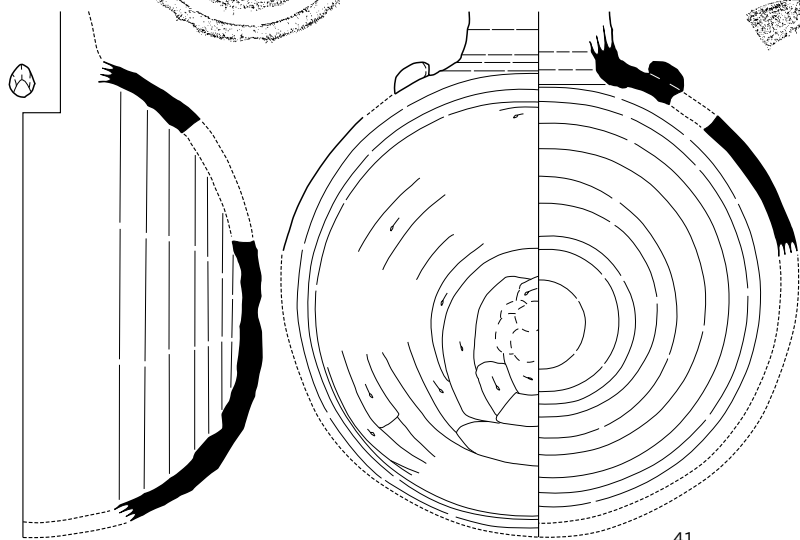
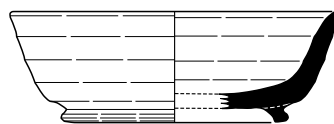
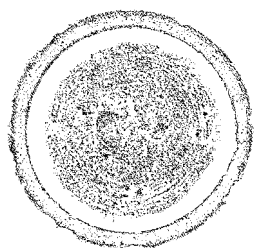
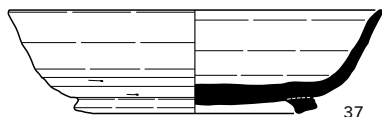
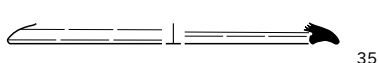
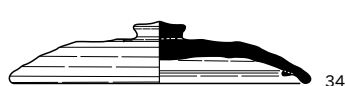
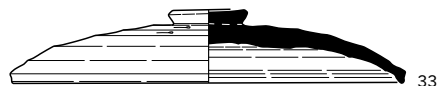
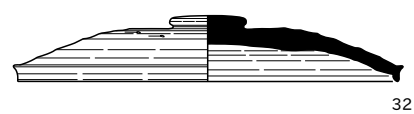

SD157(45~60)

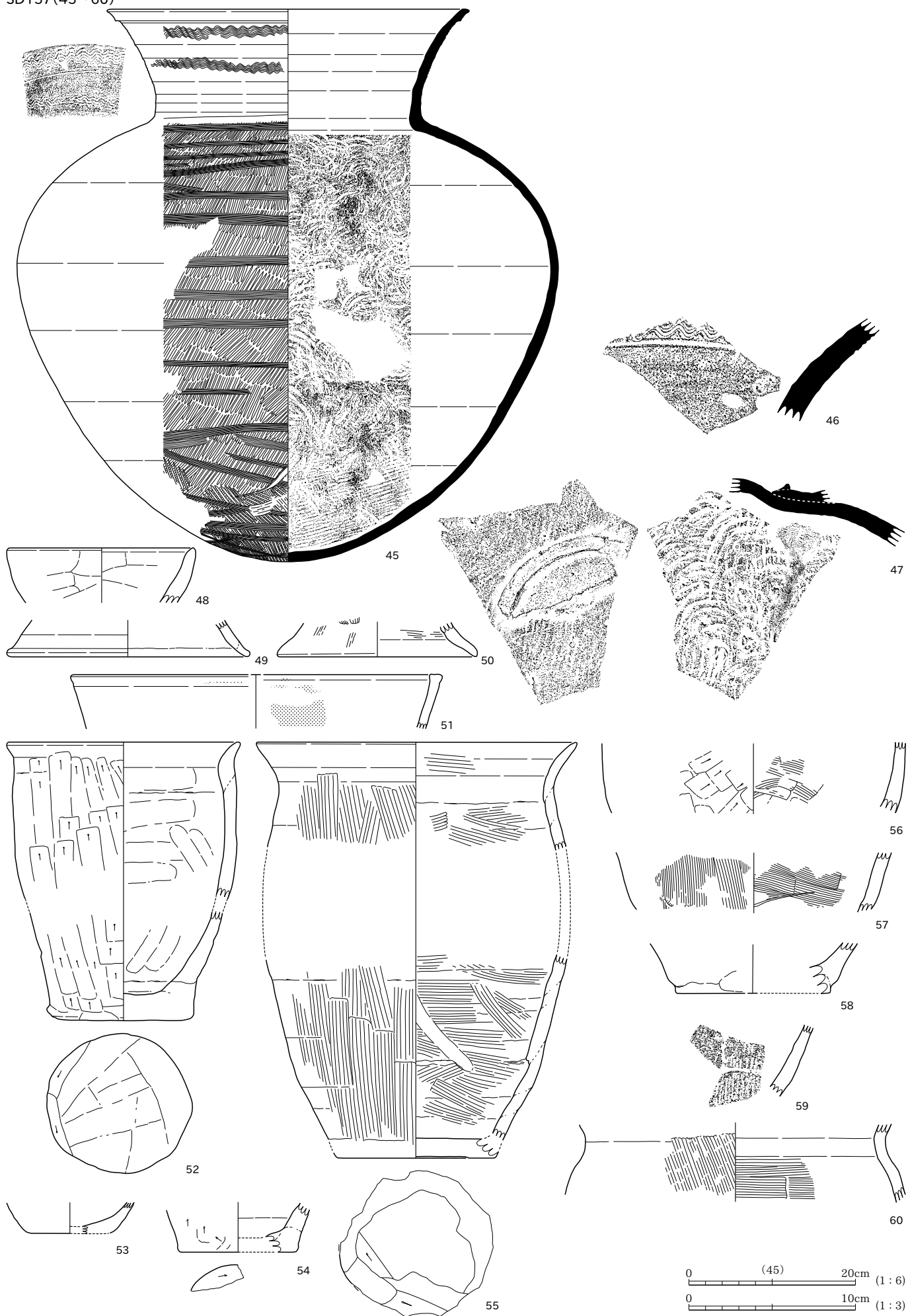

SD157(61・62)

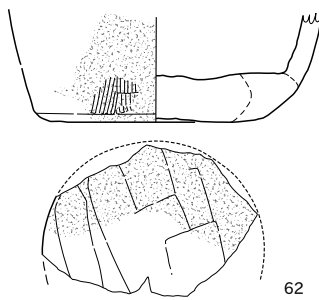
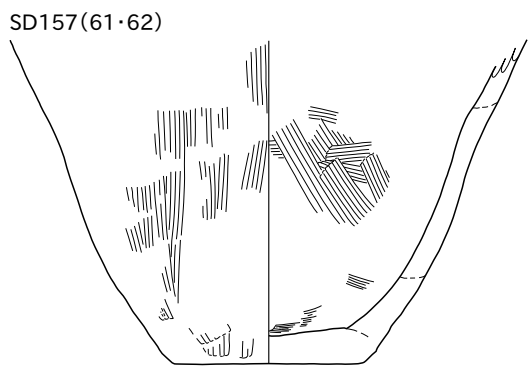

SD155(63~80)

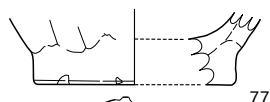
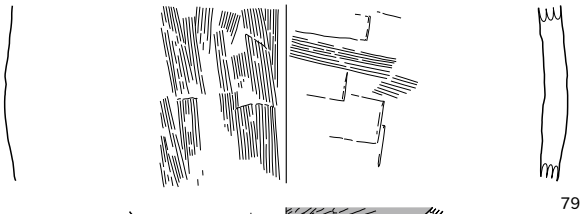
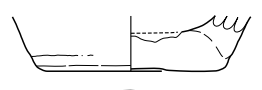
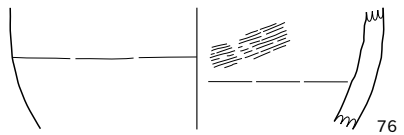
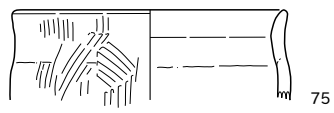
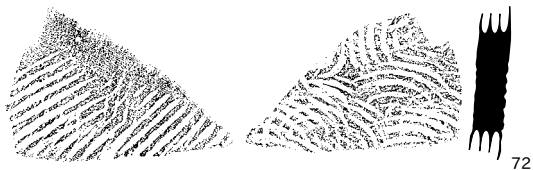
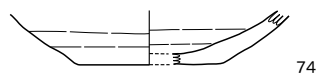
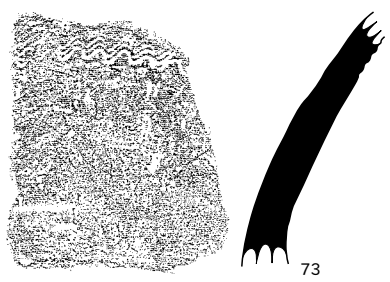
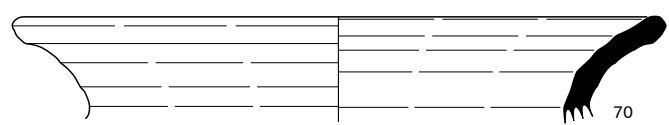
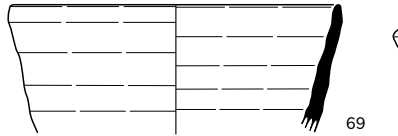
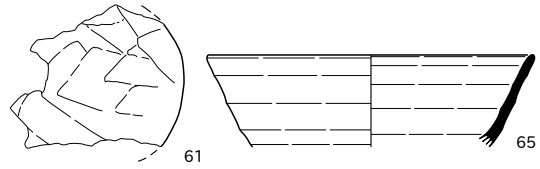
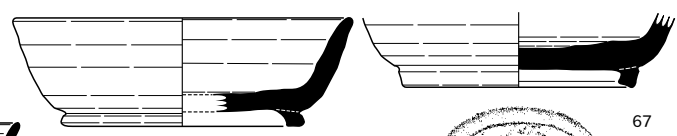
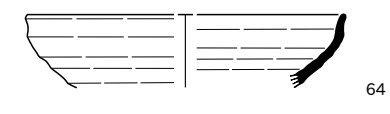
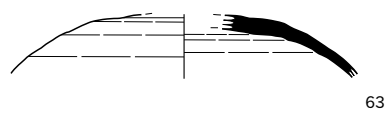

SD154(81~89)

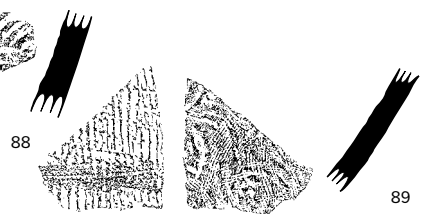
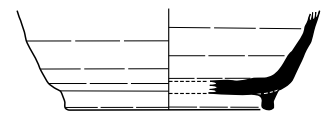
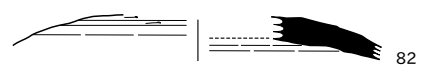

SD156(90~95)

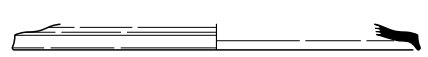
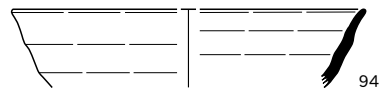
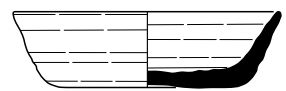

SD156(96~103)

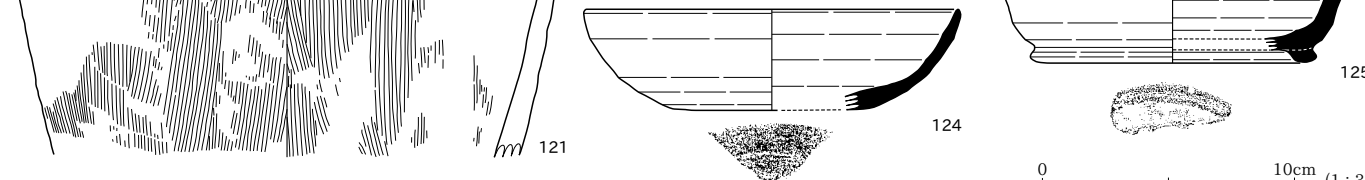
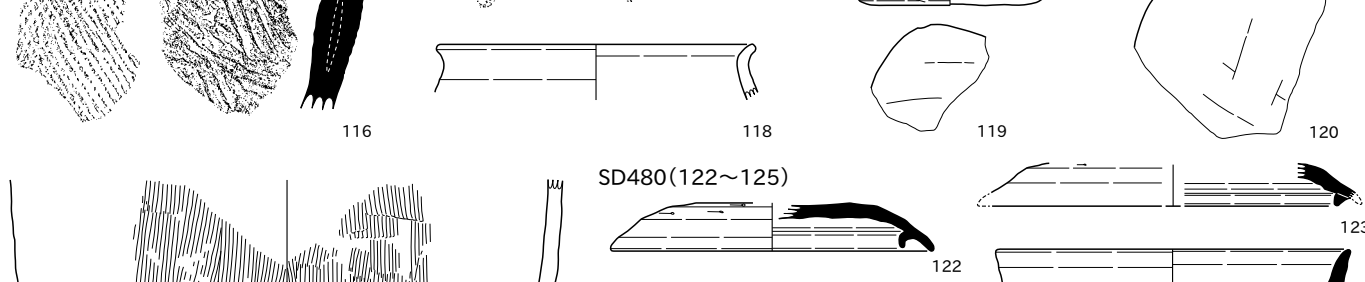
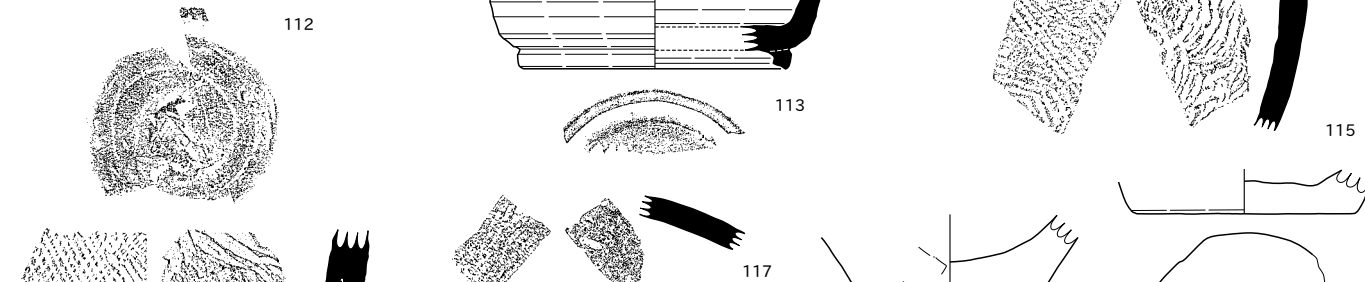
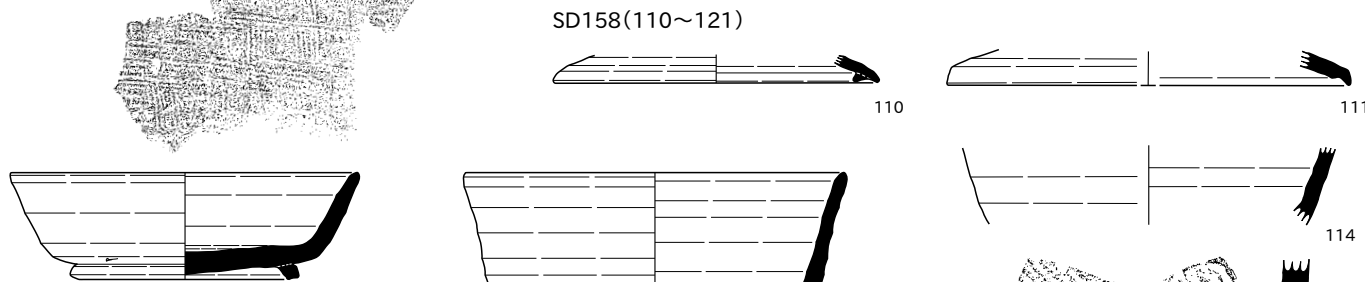
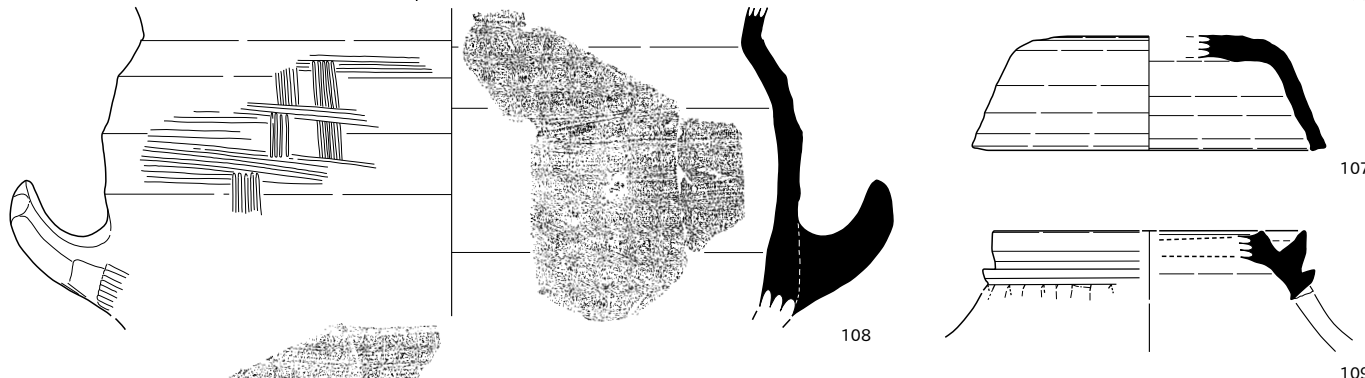
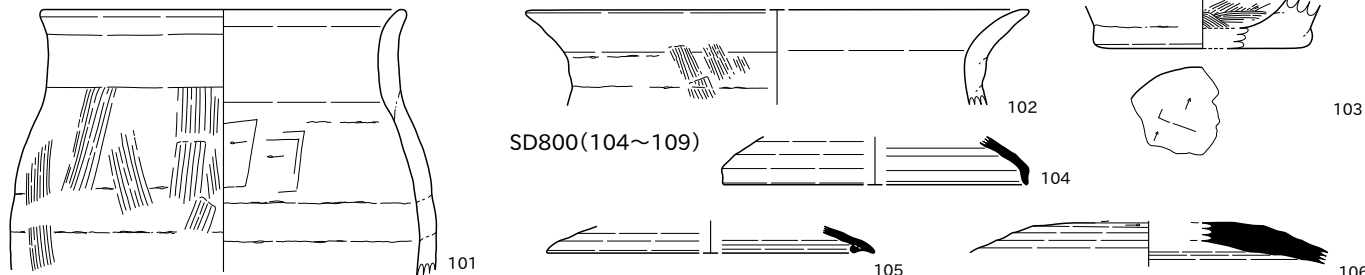
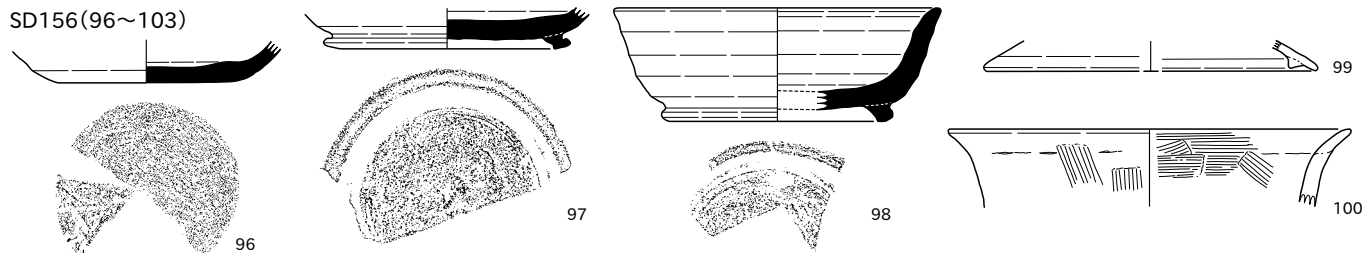

0 10cm (1:3)

SD480(126~133)

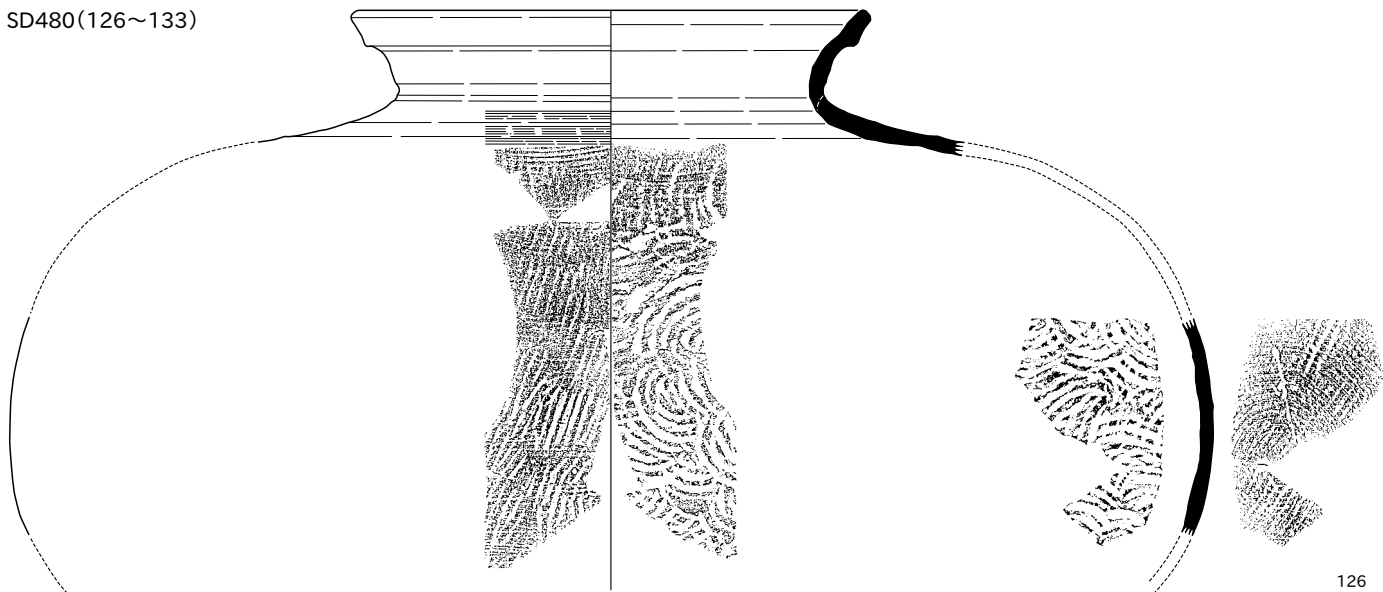

126

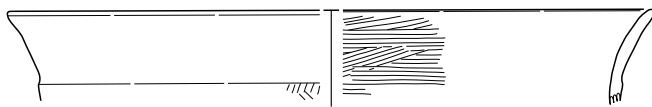
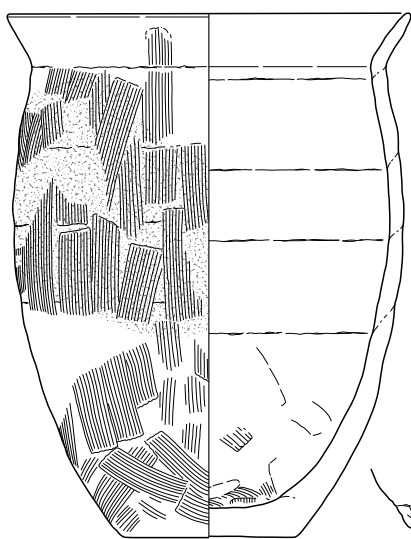

128



129



130

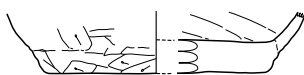

131

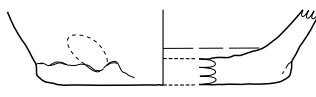

132



133

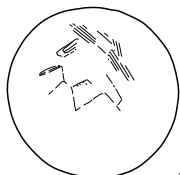

127

SE78(135)



135

SE242(134)



134

SE80(136-137)

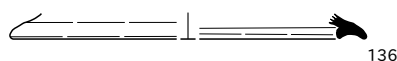

136

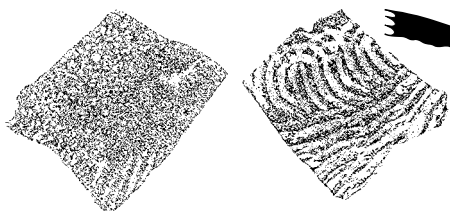

137

SE170(138)

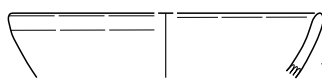

138

SE183(139)

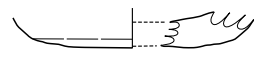

139

SE57(140)

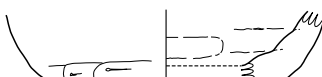

140

SE542(141)



141

0 10cm (1:3)

SE522・710・805・882・912・1037, SK69・83・620・666・758・766・804・916・1008・1115

SE522(142)



SE710(143)



SE912(144)

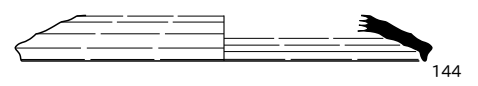

SE882(145)



SE805(146)



SE1037(147)

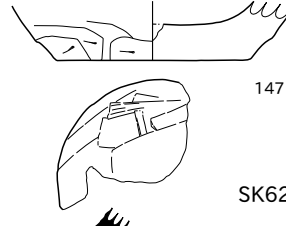

SK83(149)



SK69(148)



SK620(150)

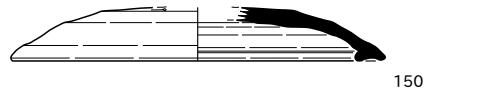

SK666(152~161)

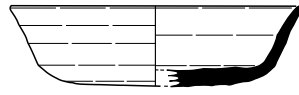
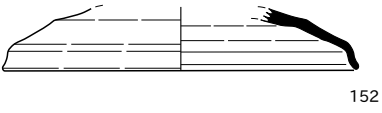

SK766(151)

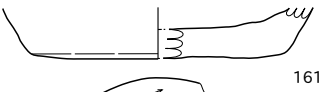
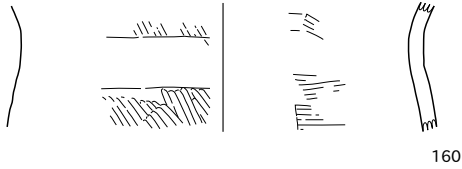
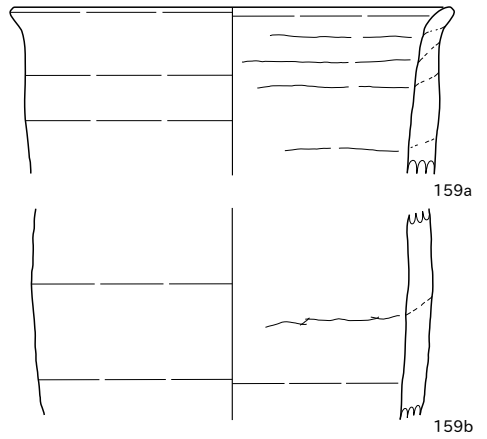
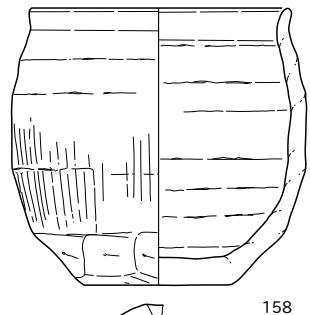
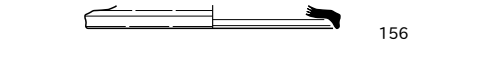
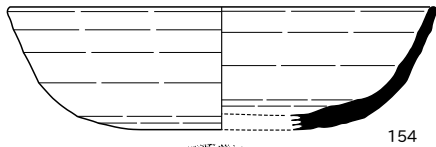
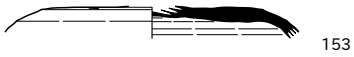

SK916(162・163)

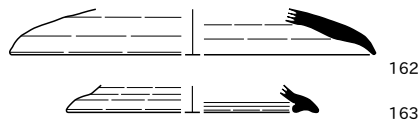

SK1008(164)



SK1115(165・166)

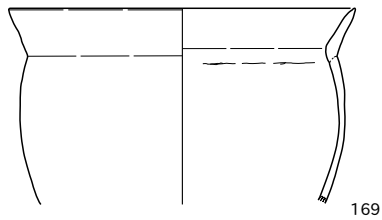
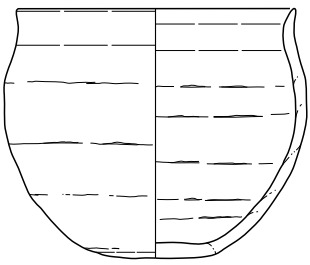
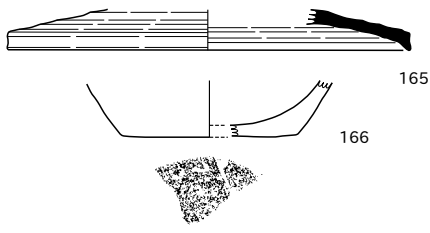

SK758(167~169)

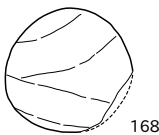
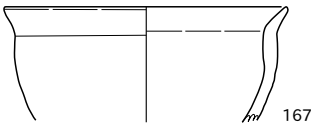

SK804(170)



SK1248(171~175)

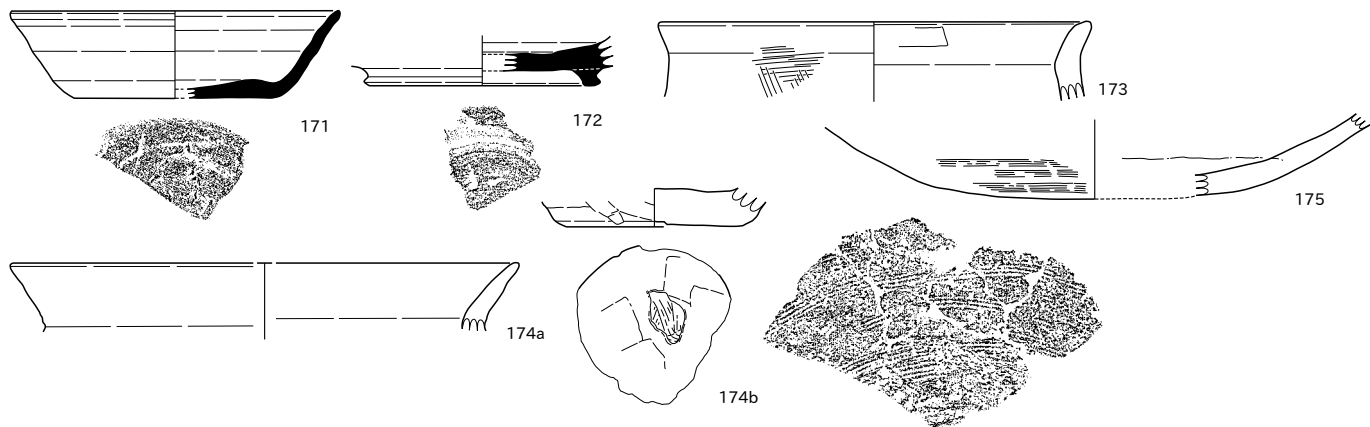

SK647(176)

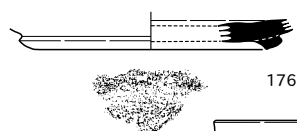

SK1028(177~182)

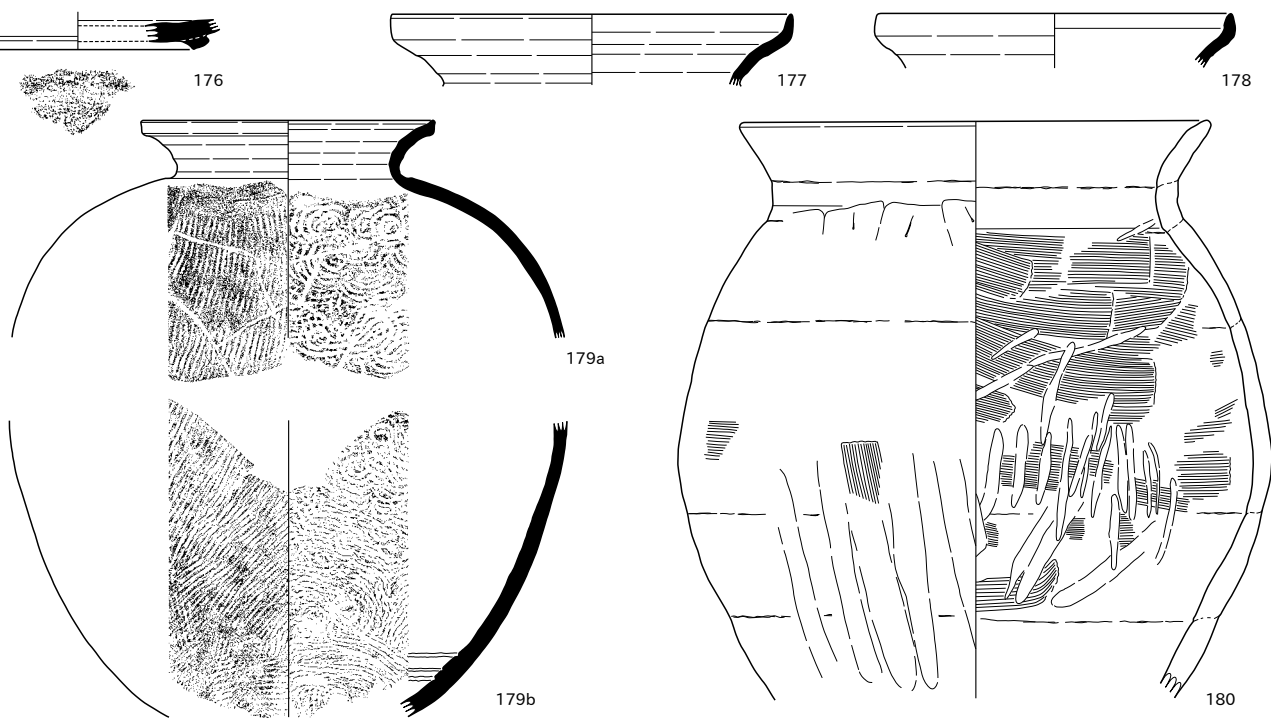

SK1500(183)

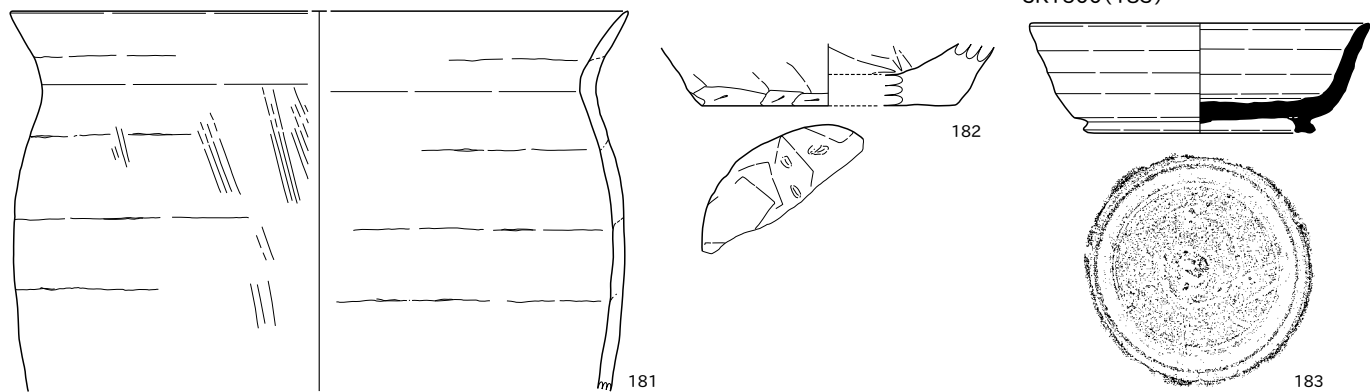

SX275(184~186)

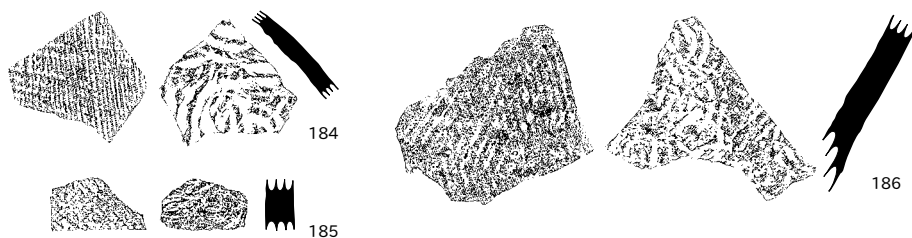

SX227(187)

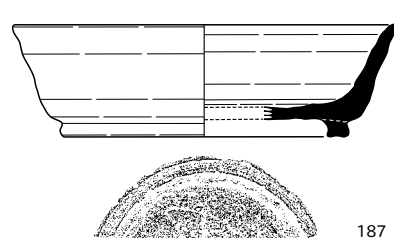

SX227(188~196)

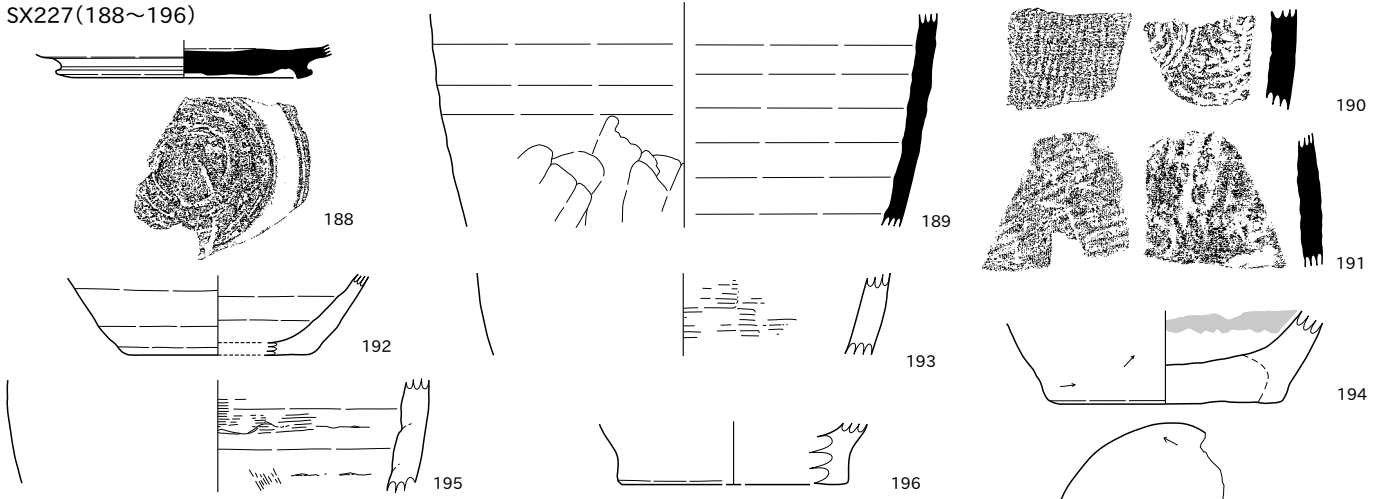

SX1020(197~198)

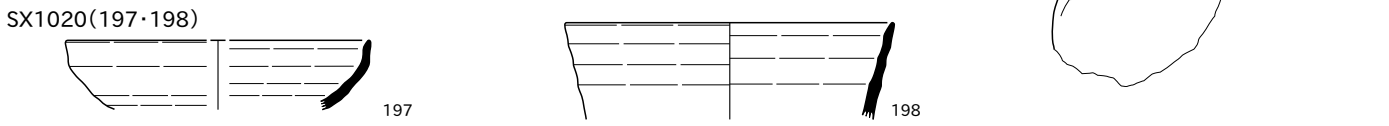

SX841(199~209)

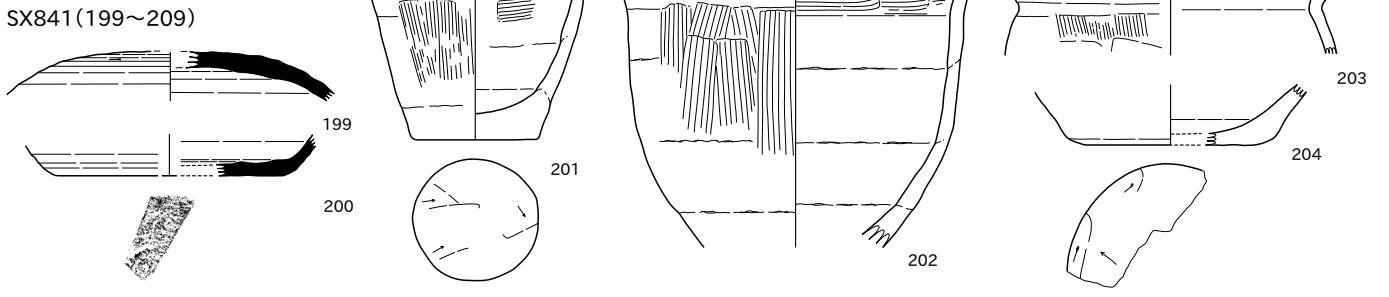

SX871(210)

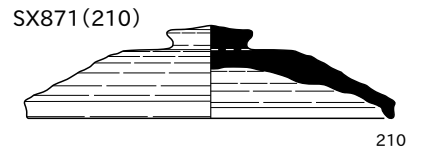

SX1088(211~220)

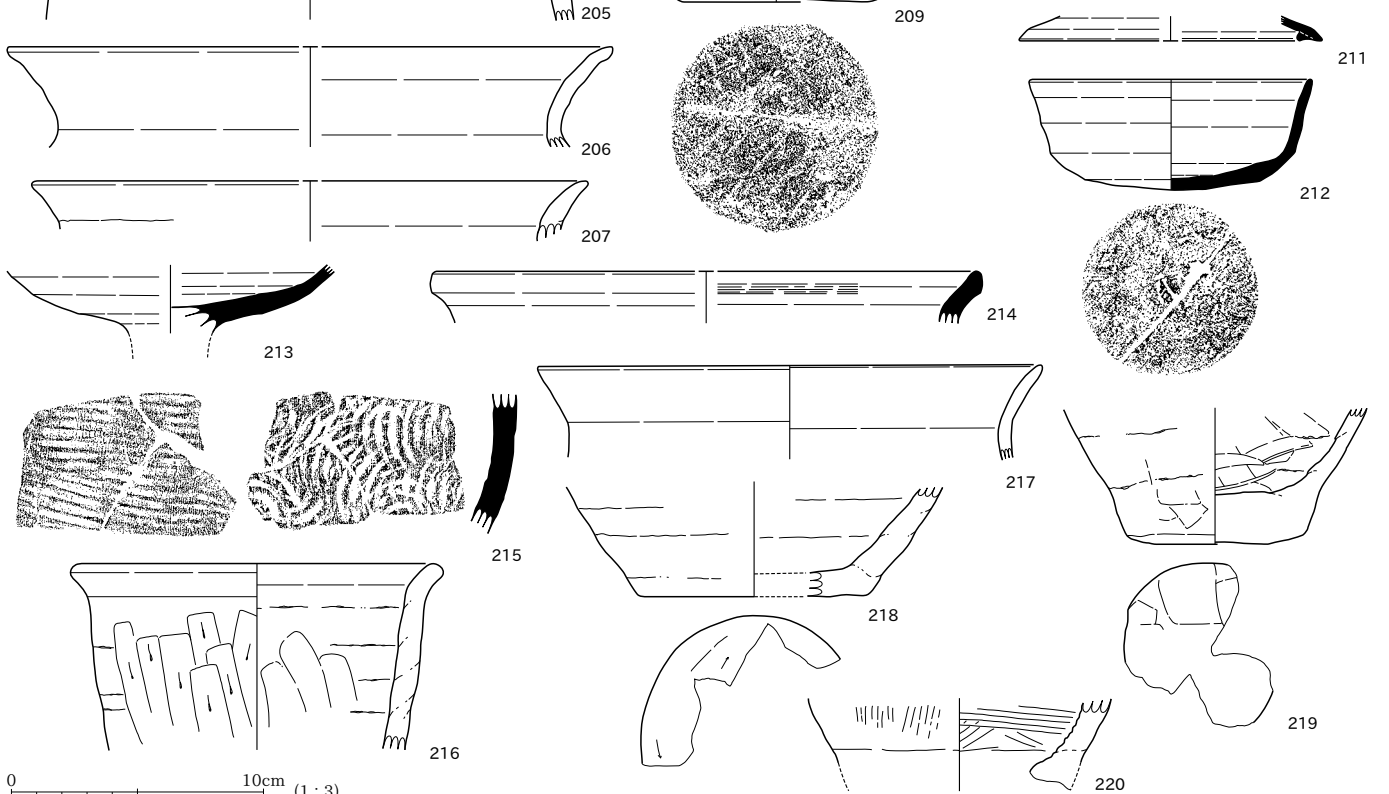

SX473(221~240)

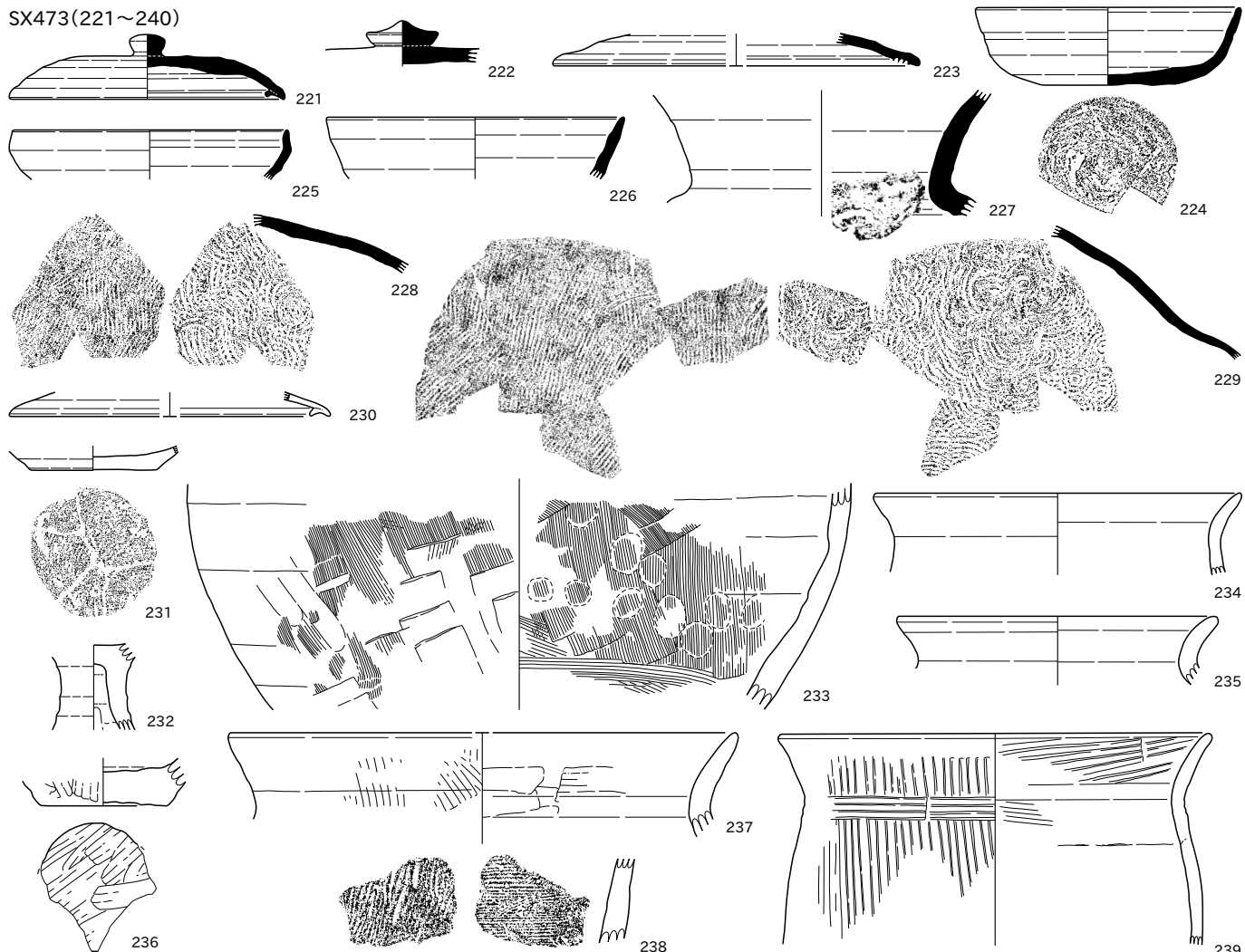

SX950(241)

SX946(242~247)

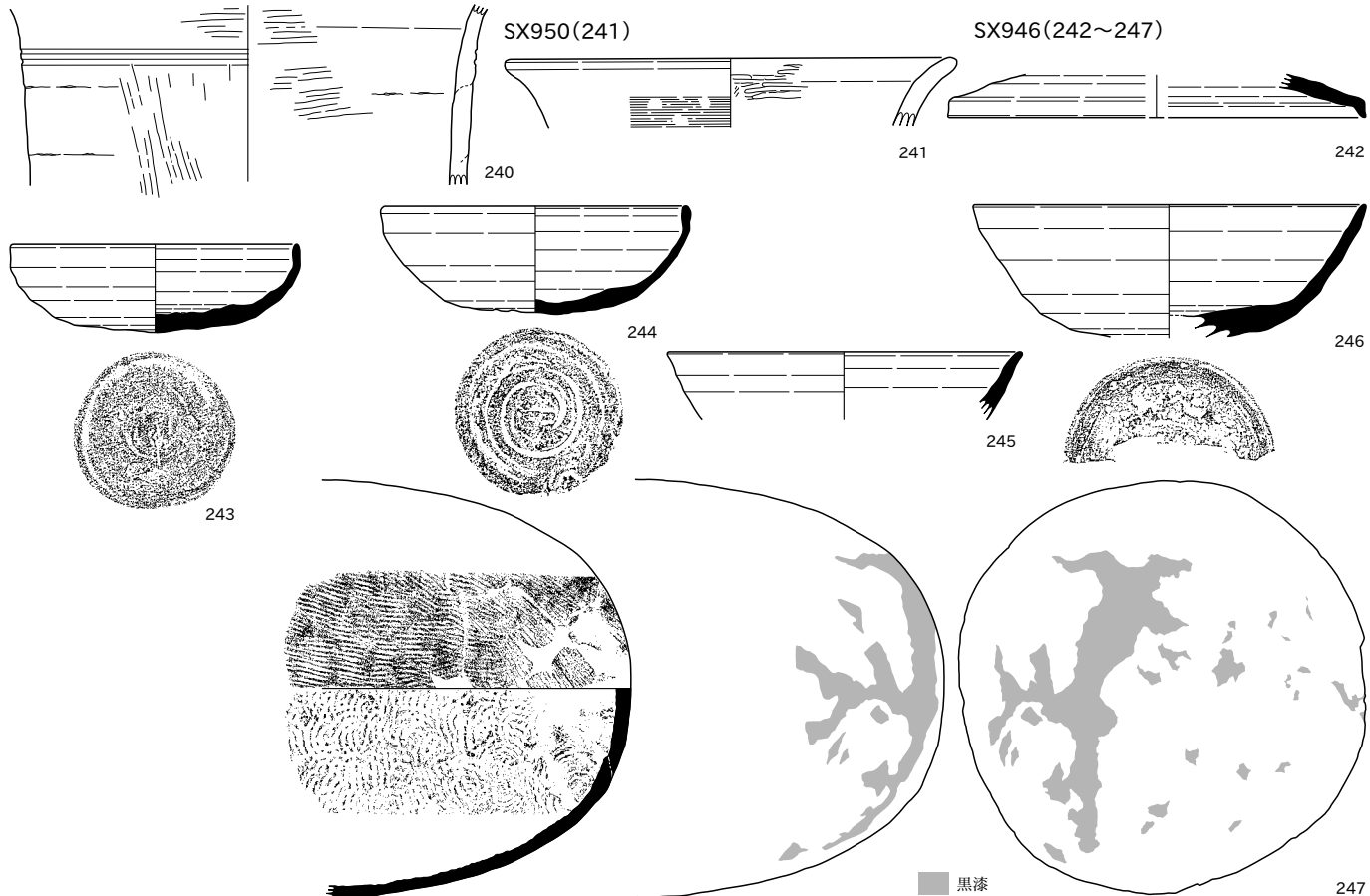

0 (228・229・247) 20cm (1:6) 0 10cm (1:3)

SX946(248~254)

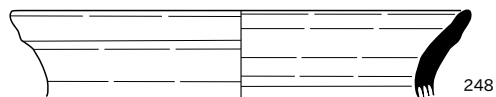

248

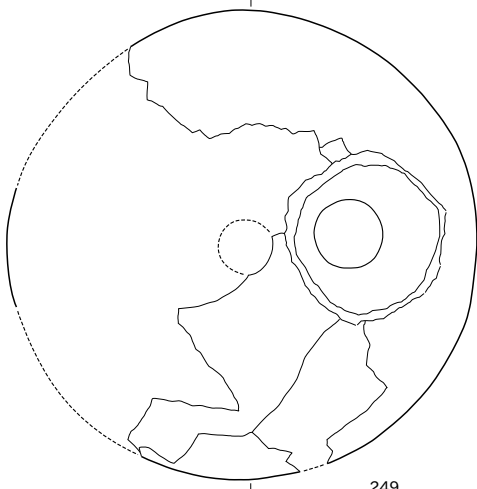
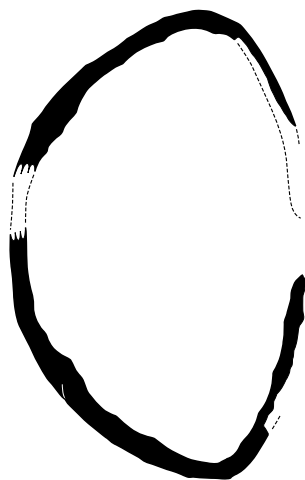
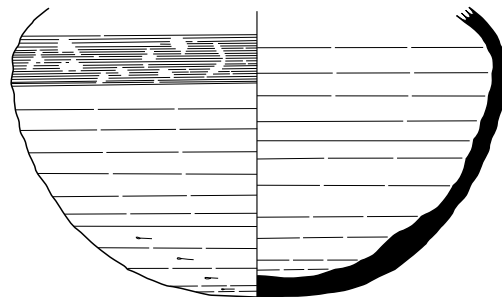
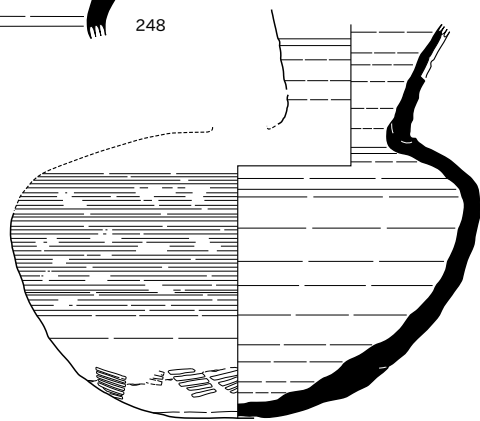

249

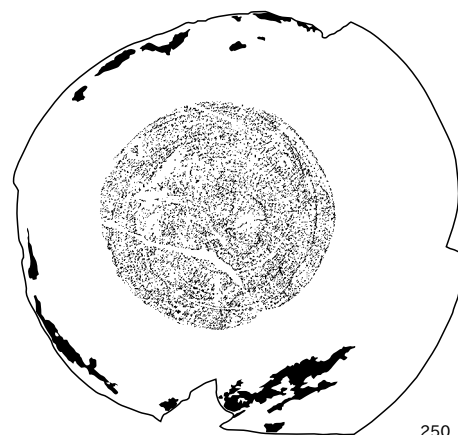

250

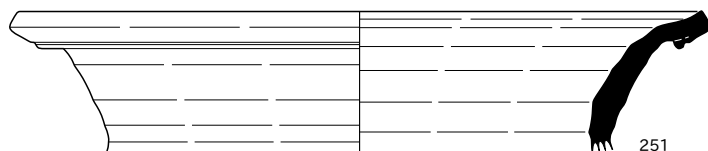

251

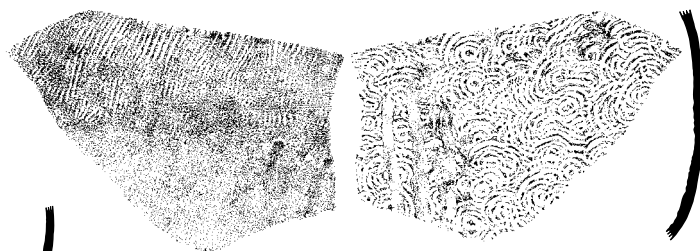

252

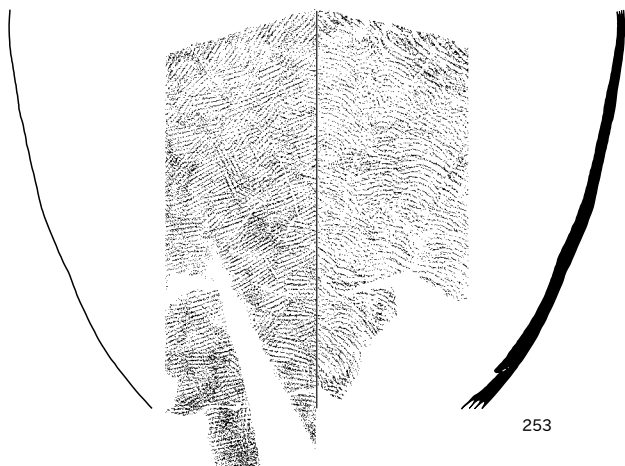

253



254

0 (252-253) 20cm (1:6) 0 10cm (1:3)

SX946(255~257)

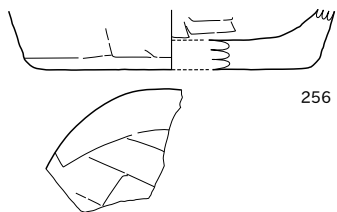
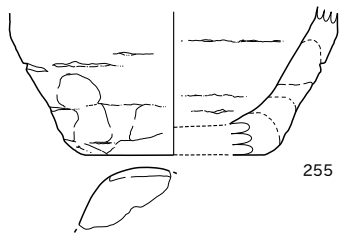

SX947(258~259)

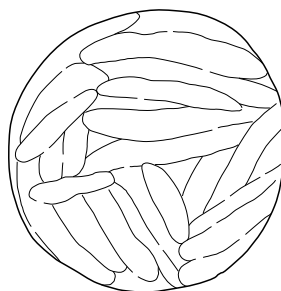
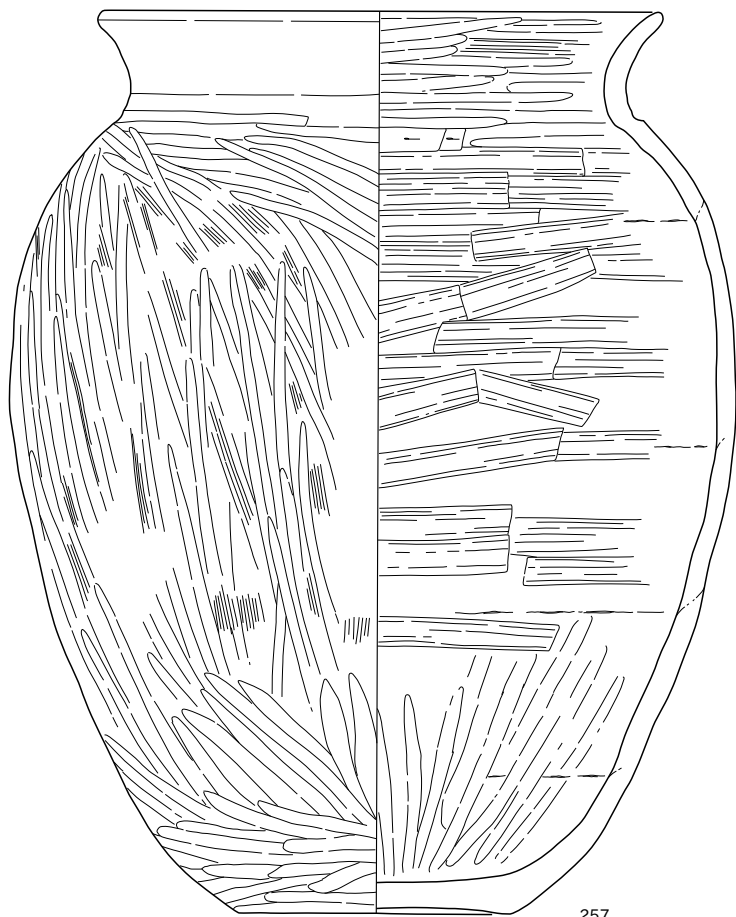
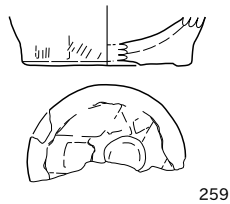
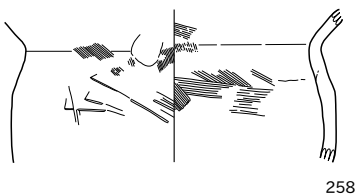

SX945(260~268)

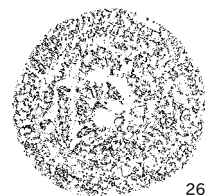
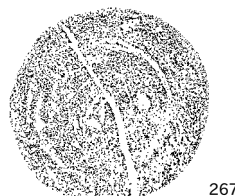
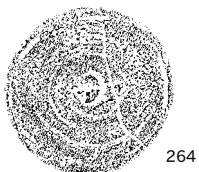
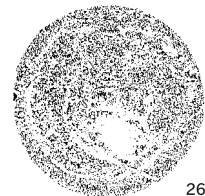
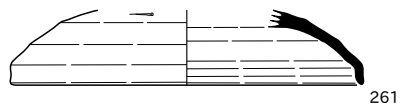
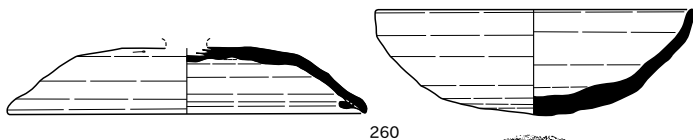

0 10cm (1:3)

SX945(269~300)

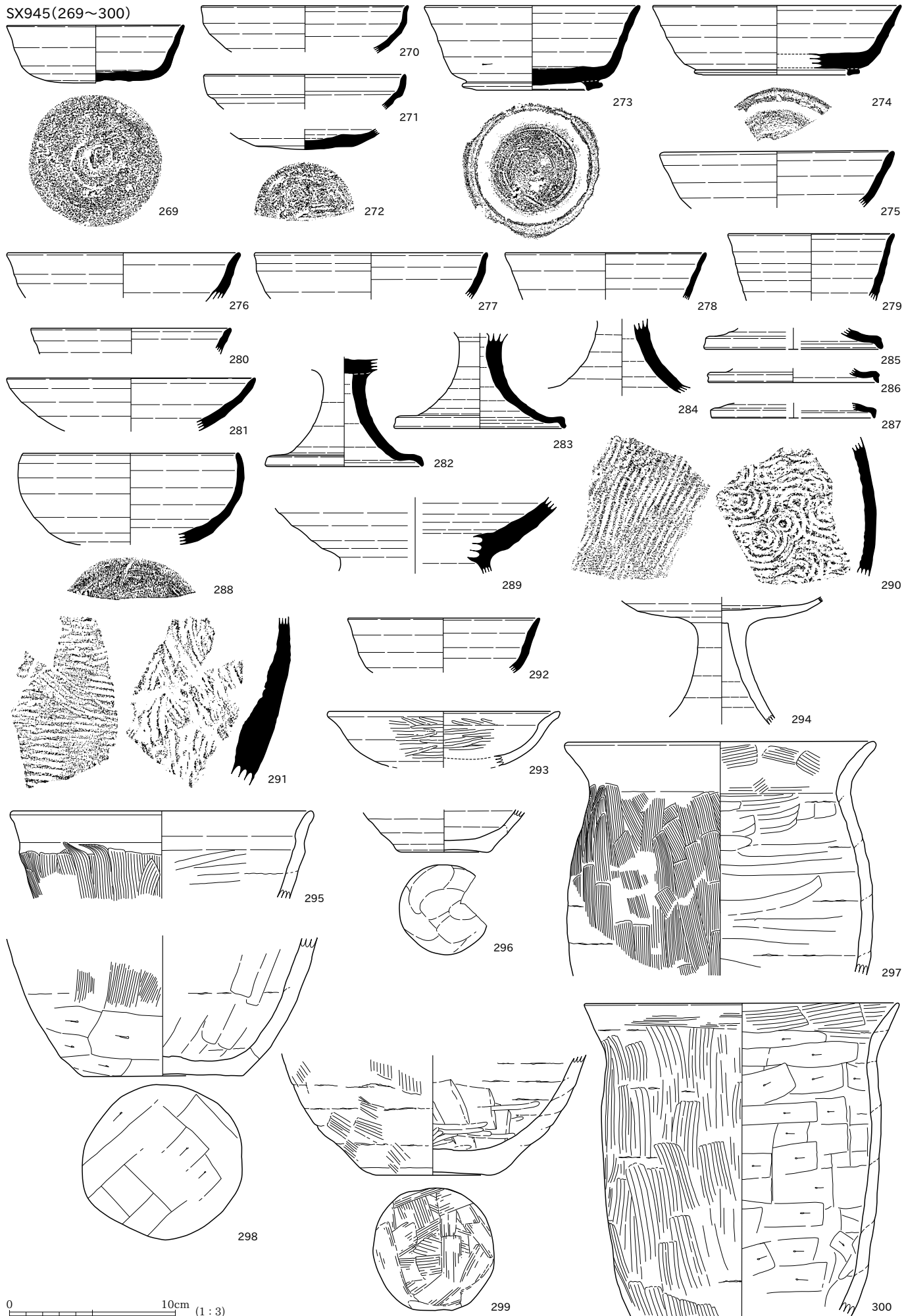

SX945(301~309)

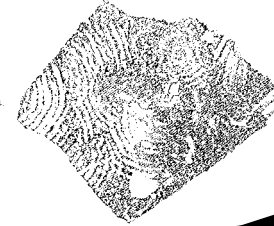
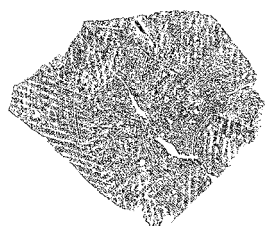
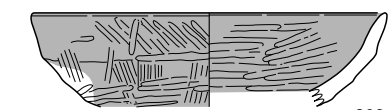
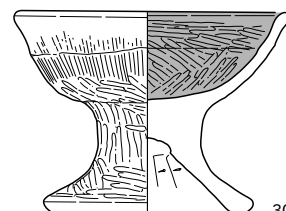
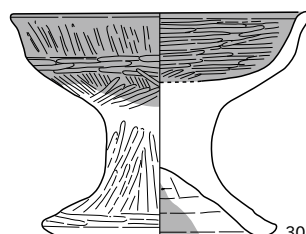
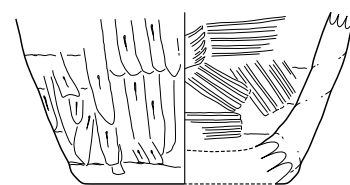
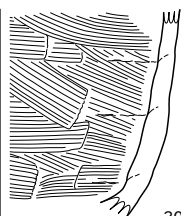
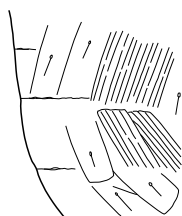
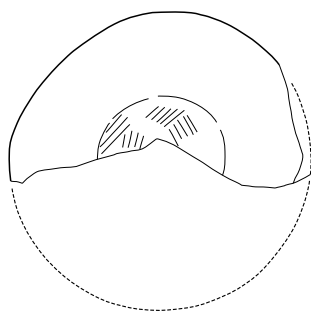
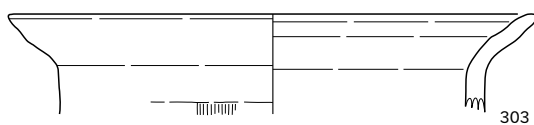
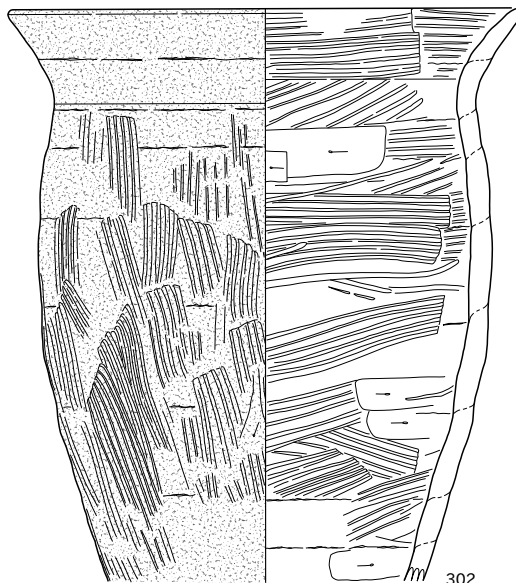
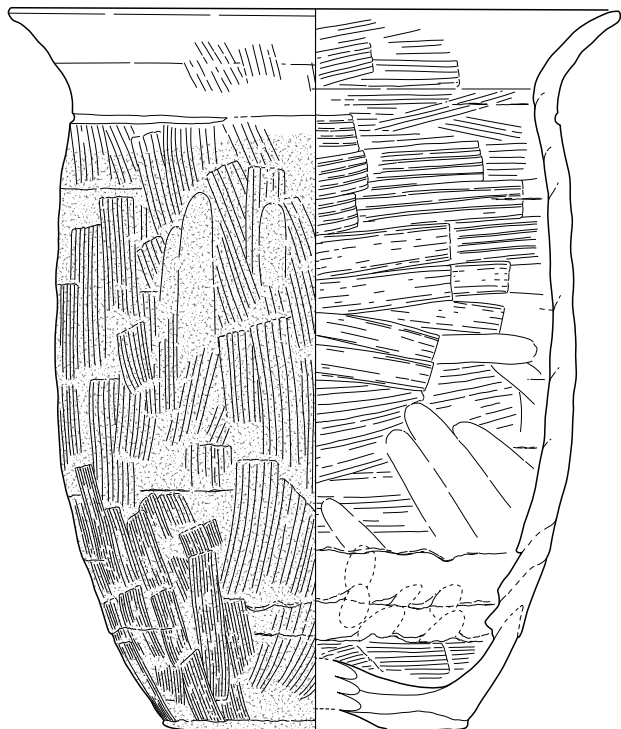

SX948(310)

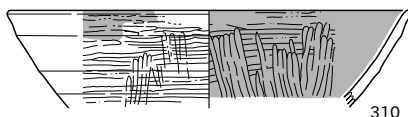

312



313

包含層 2J-10I(311~314)



311

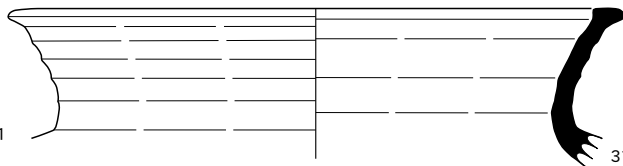

3J-2I(315)

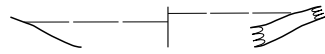

314

315

3K-2A(316)

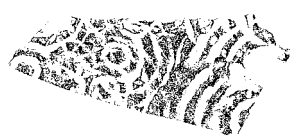

316

3K-3A(317)

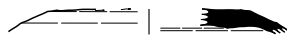

317

3J-3H(318)

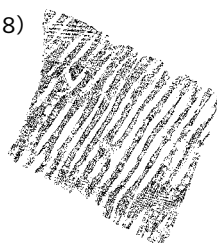

318



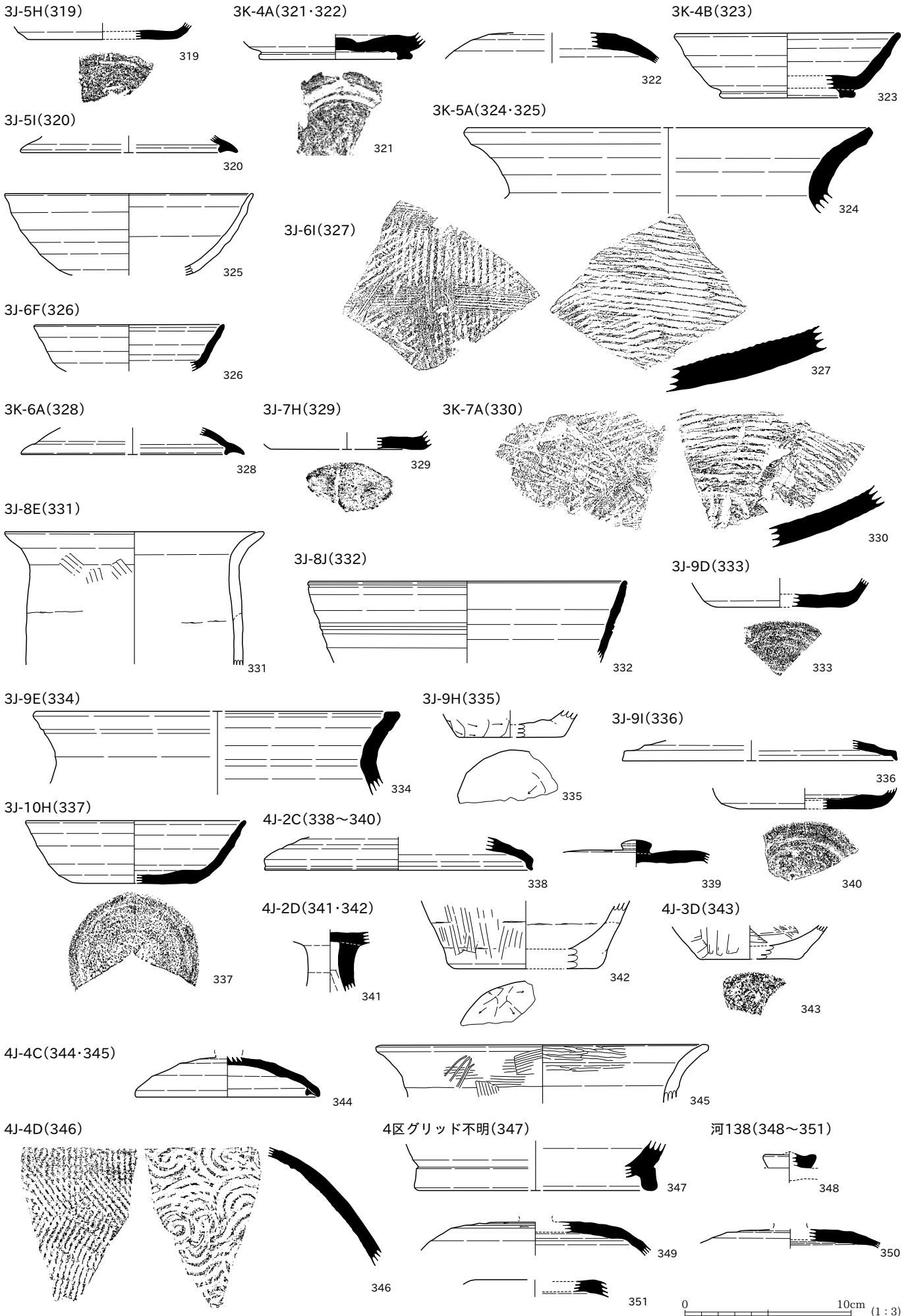

河138(352~372)

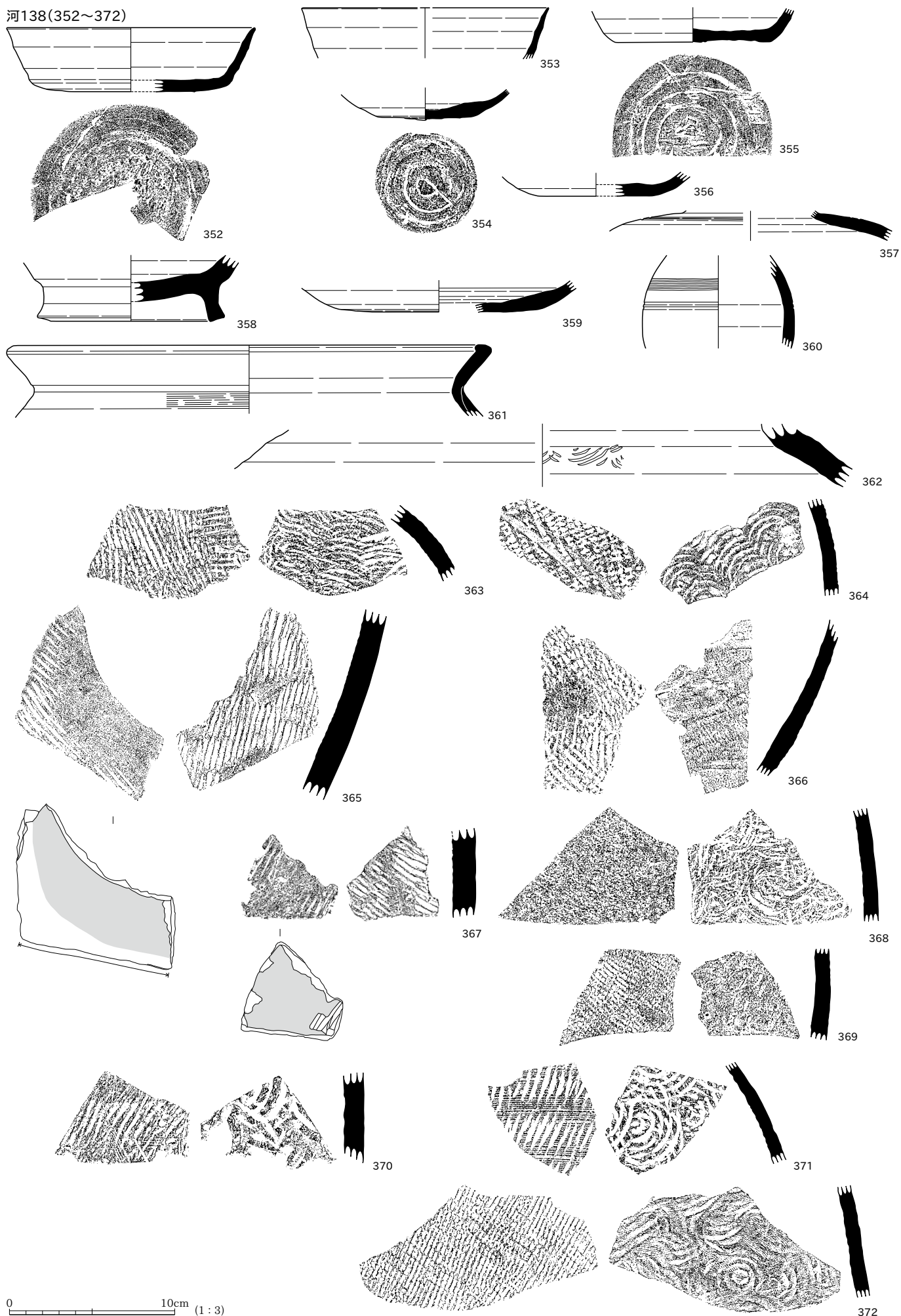

河138(373~377)

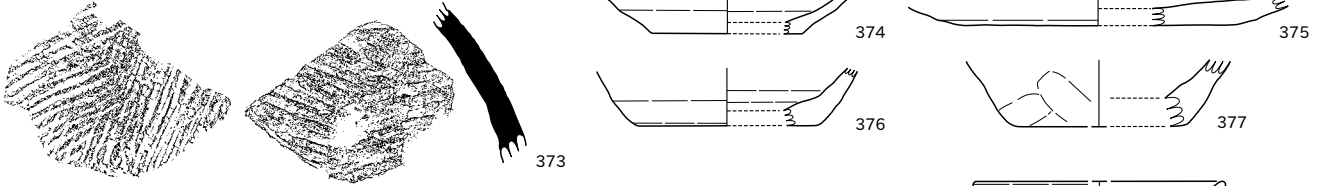

暗渠(378~380)

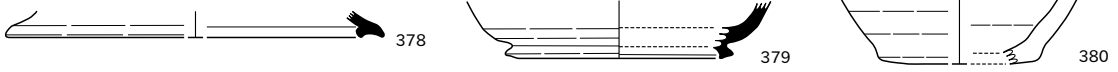

攪乱(381~390)

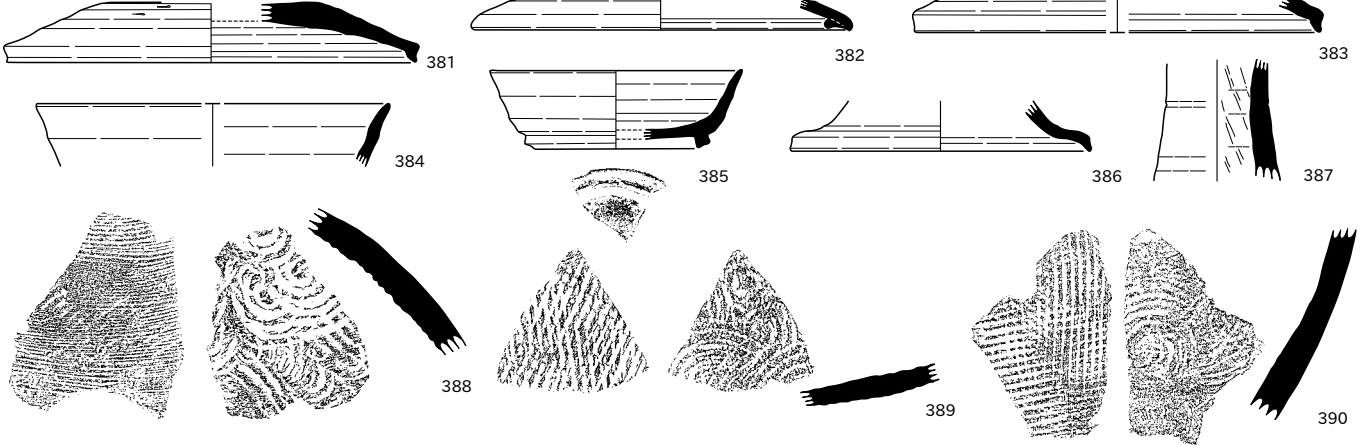

表採(391・392)

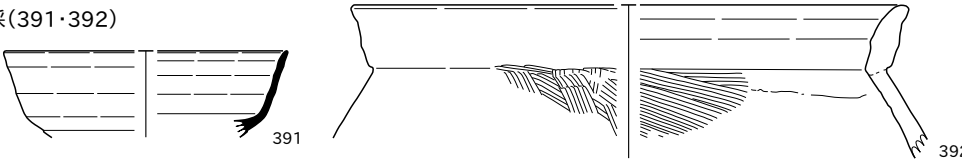

排土(393)

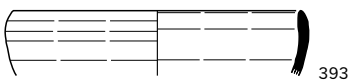

54T(394)

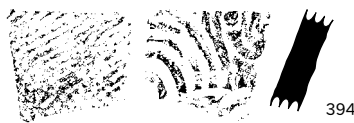

70T(396・397)

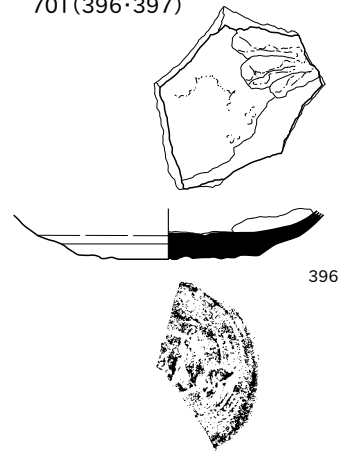

64T(395)

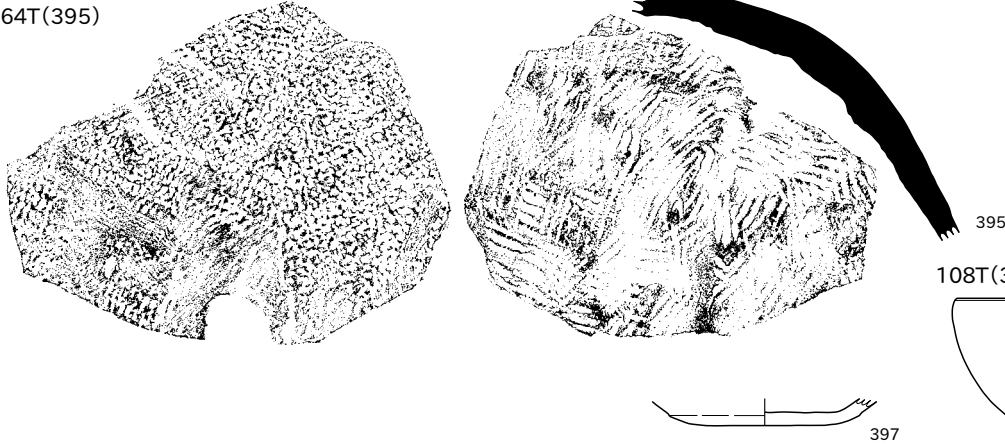

中世

SB1565P2(399)

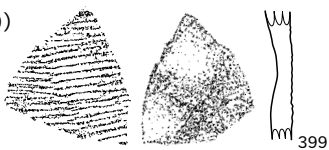

Pit571(401)



Pit161(400)



Pit572(402)

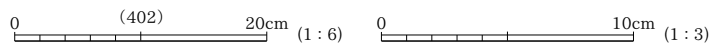
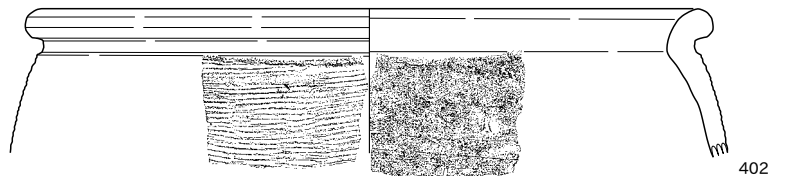

Pit587(403)

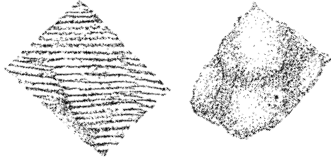

Pit1097(404)

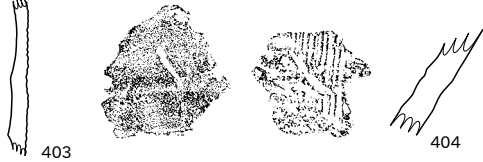

SD279(405)

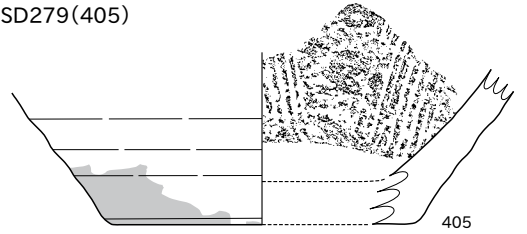

SD153(406~409)

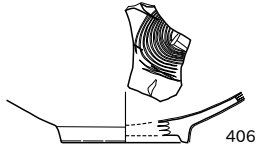

SD174(410)

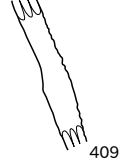
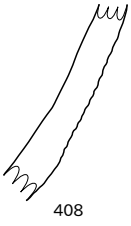
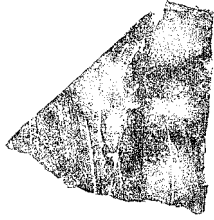
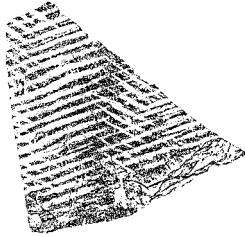
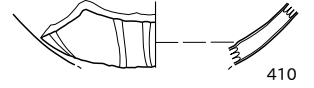

SD157(411)



SD155(412~419)

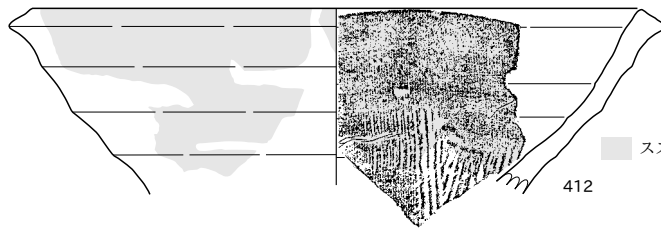
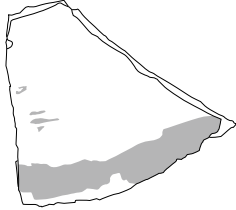

スス

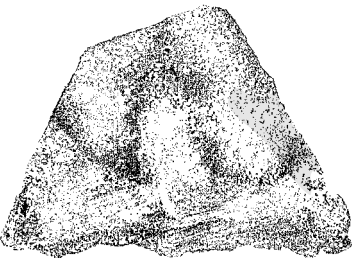
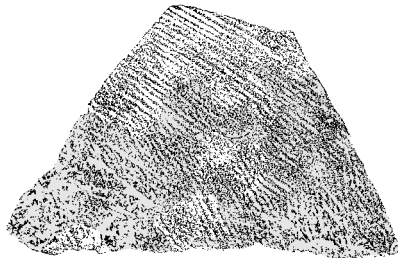
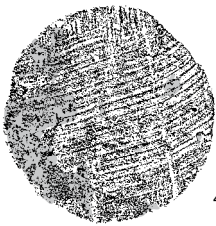
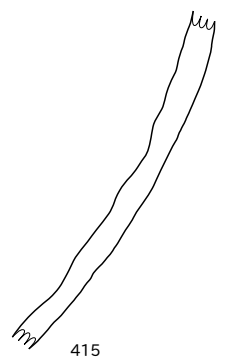
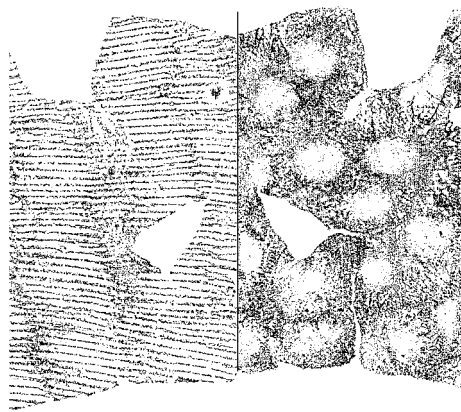
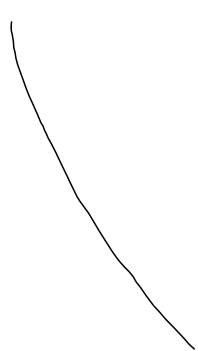
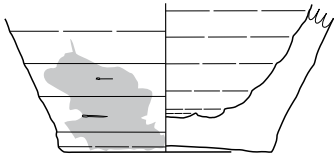
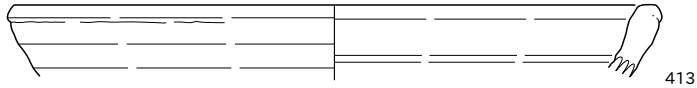

スス 416

417

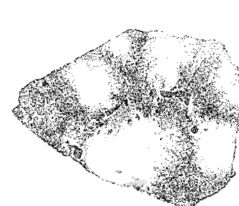
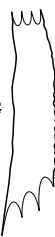

スス 419

SD155(420~425)

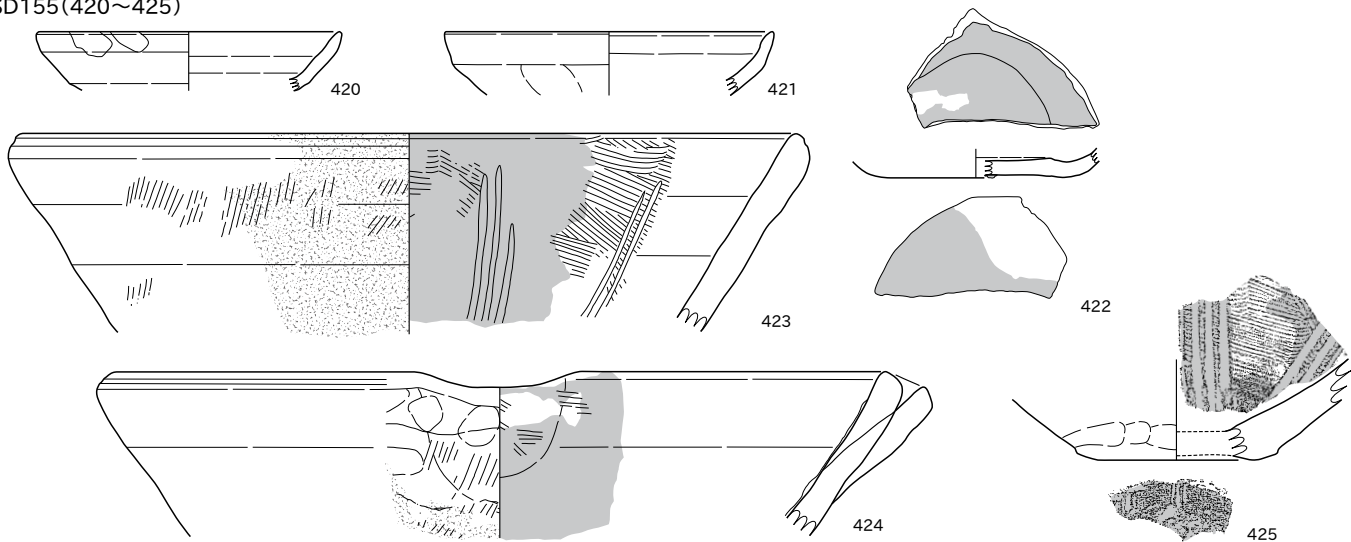

SD156(426~428)

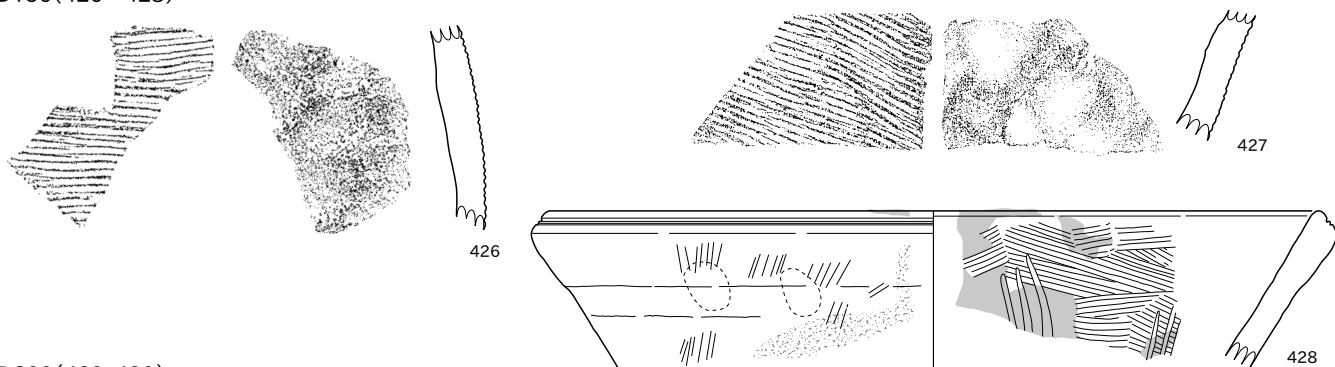

SD800(429-430)

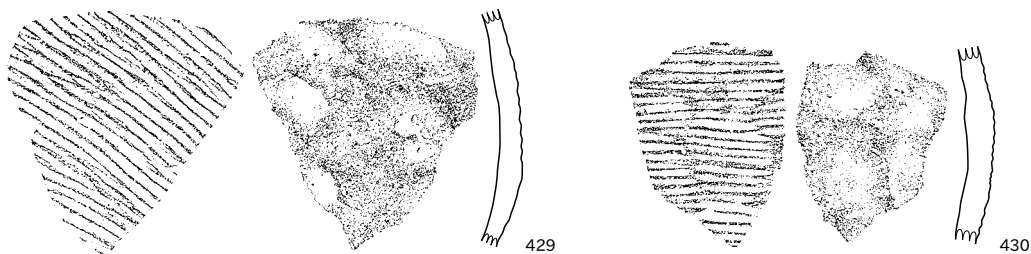

SD158(431~437)

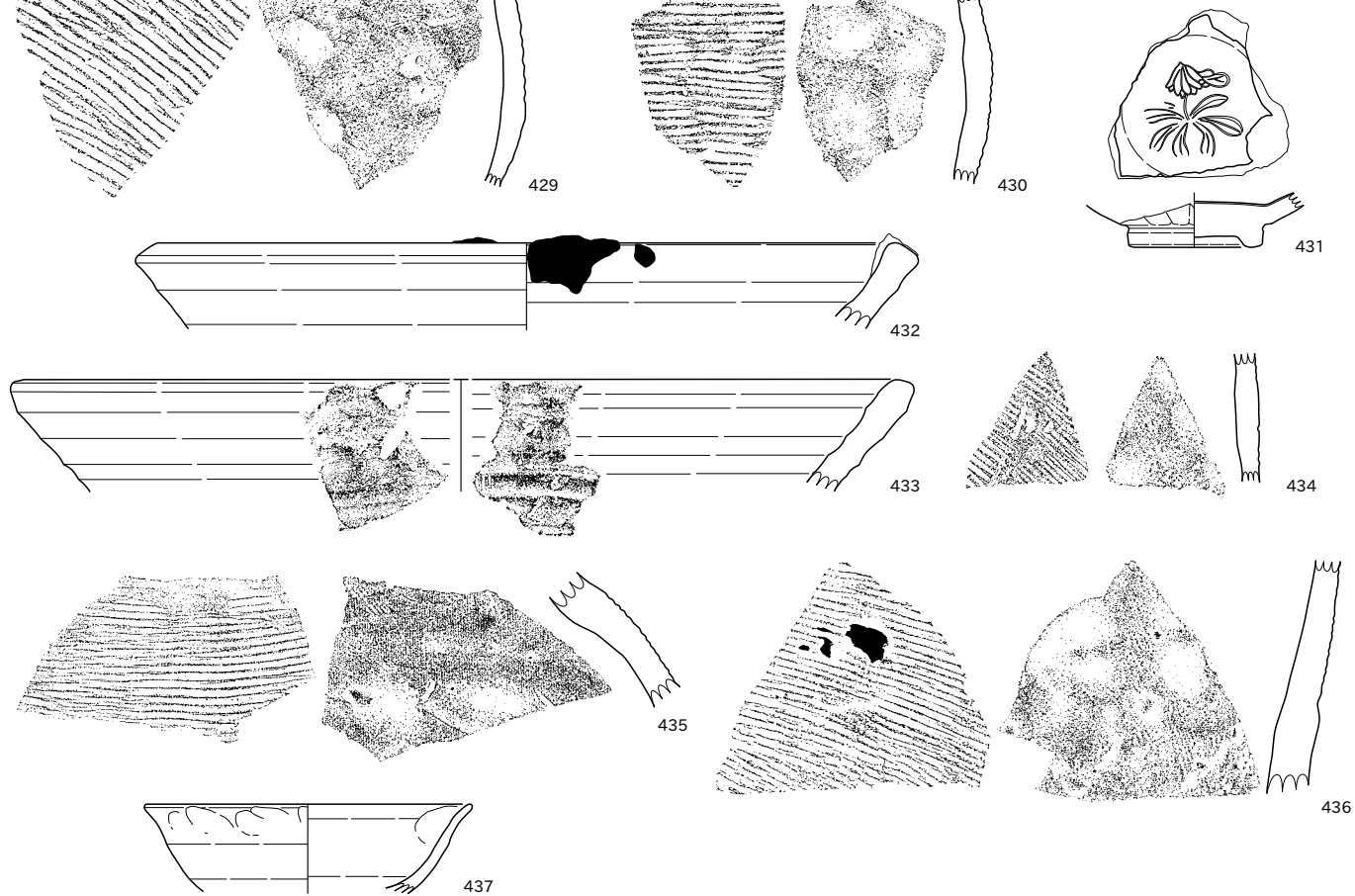

SD869(438)

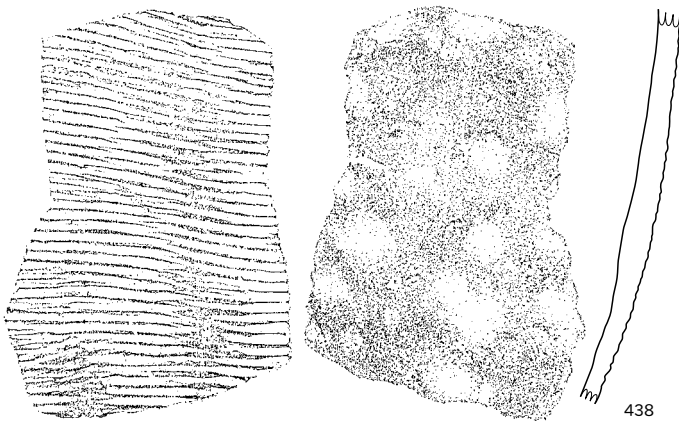

SE56(439)



SE89(440)

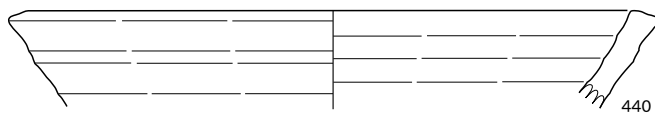

SE78(441・442)

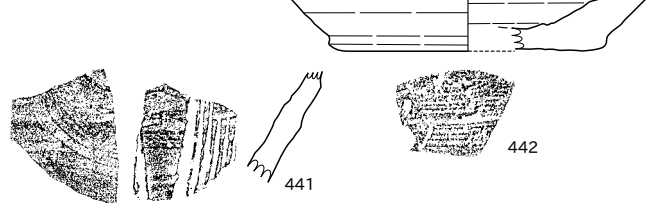

SE80(443・444)

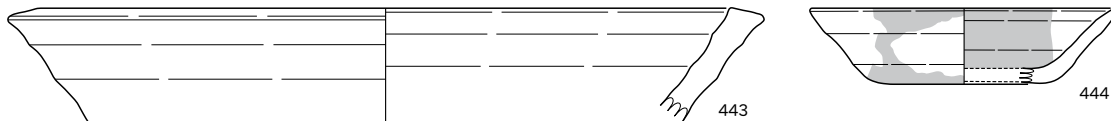

SE57(445)

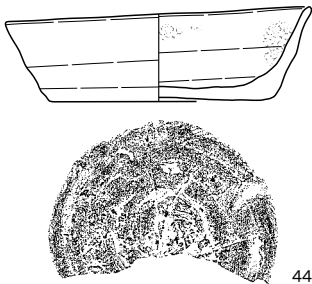

SE497(446)

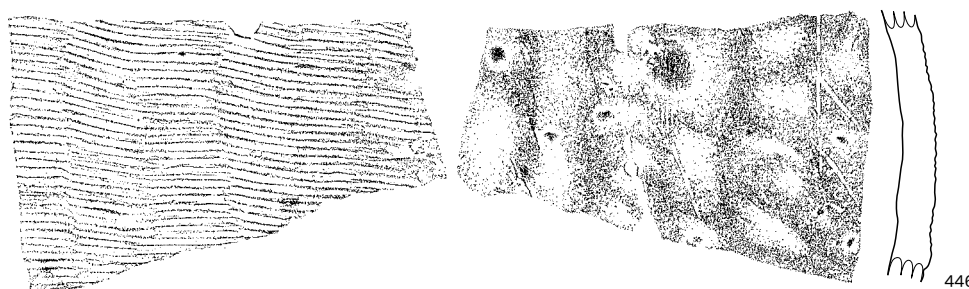

SE542(447・448)



SE588(449)

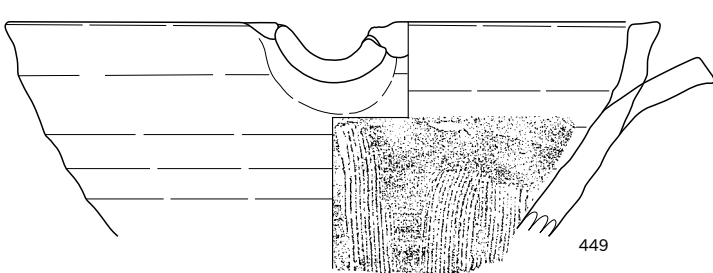

SE485(450)



SE105(451)

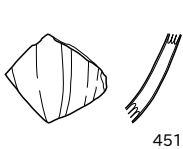

SE522(452)

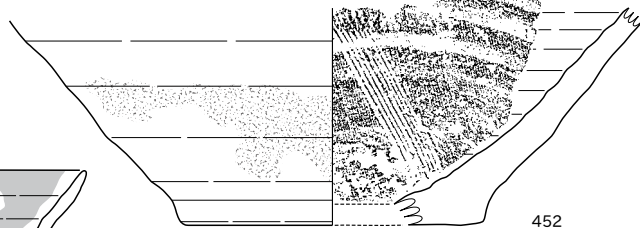

SE577(453・454)

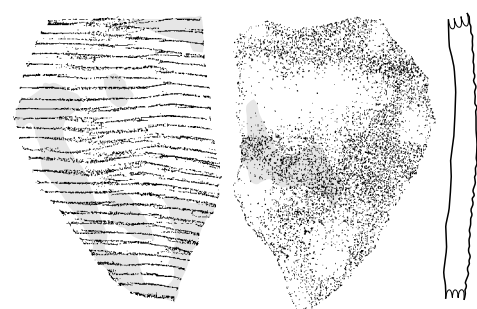

SE917(455)



SE710(456)



スス 453

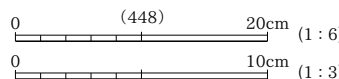

SK69(457・458)

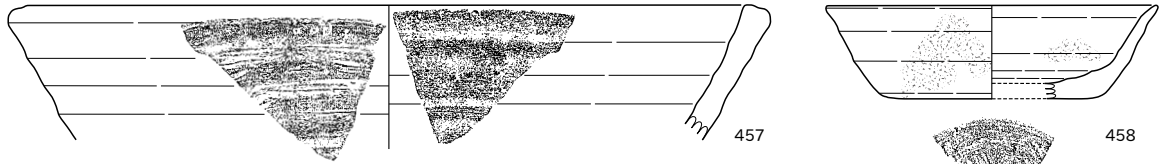

SK71(459)

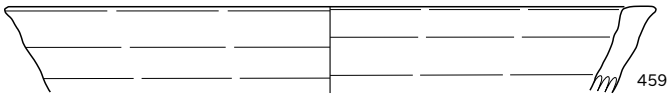

SK1500(460)

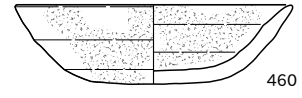

SX15(461・462)

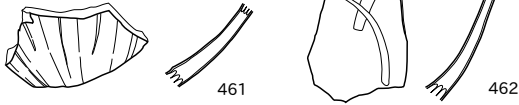

SX521(463~465)

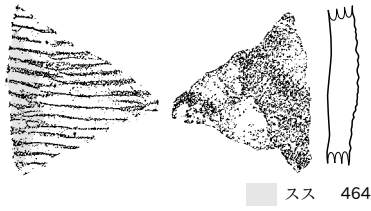
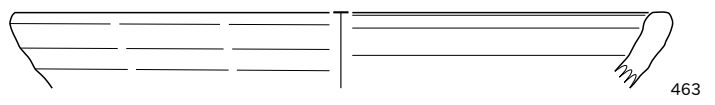

包含層 2J-10I(466)

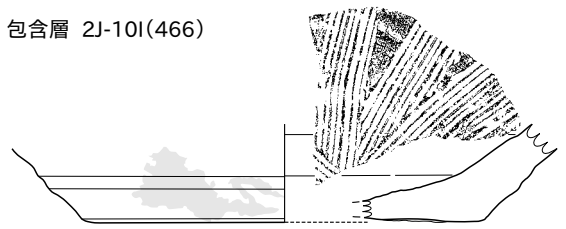

3J-1I(467)

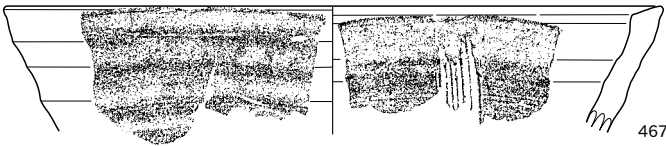

スス 466

3J-2J(468)

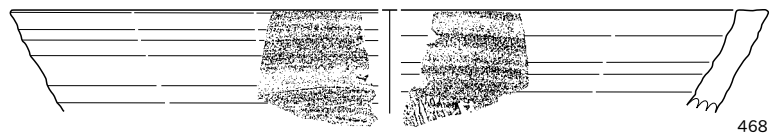

3J-3H(469)

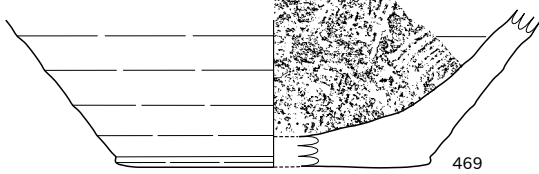

3J-3J(470)

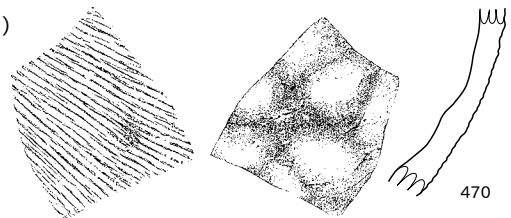

3J-4H(471)

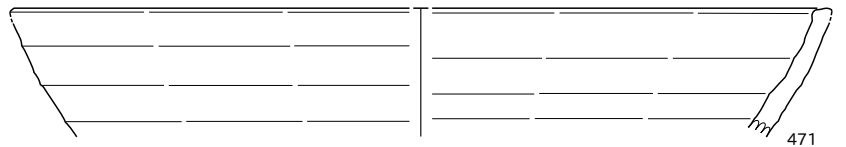

3J-5G(472・473)

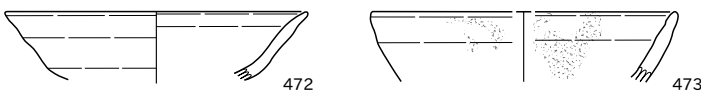

3J-5J(474)

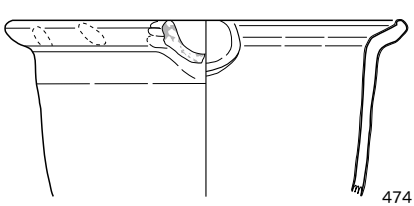

3J-6H(475)

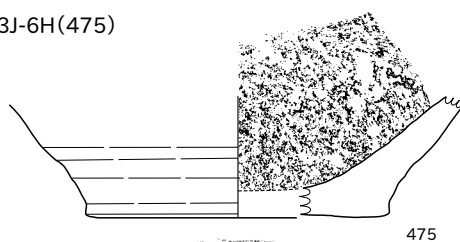

3J-6I(476)

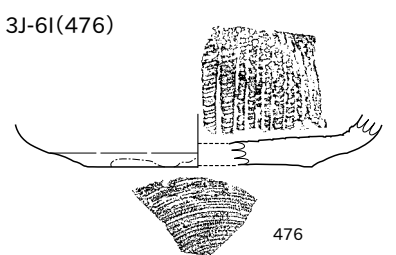

3J-6I(477)

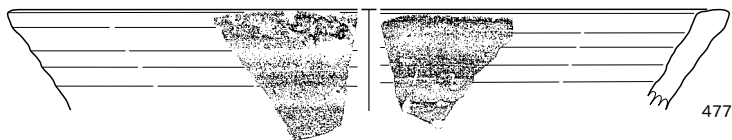

3J-7E(478)

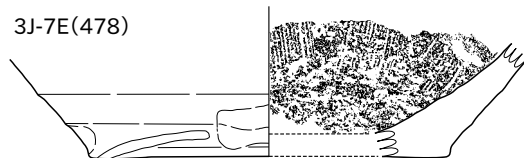

3J-8J(479・480)

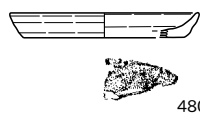
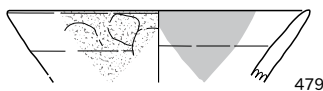

3J-9F(481)

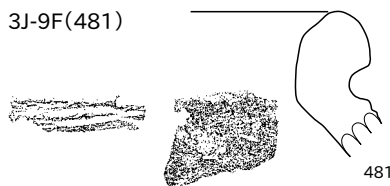

3J-9I(482)

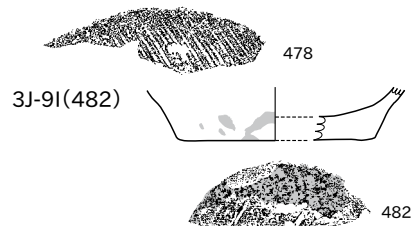

3J-10F(483)

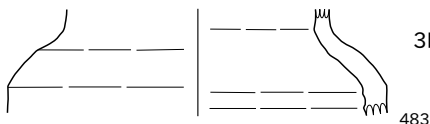

3K-4A(484)



グリッド不明(485)

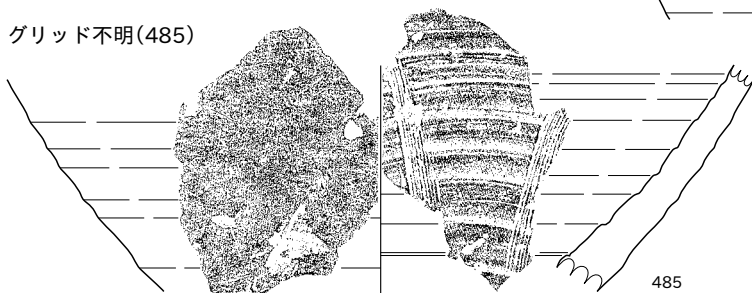

河138(486~493)

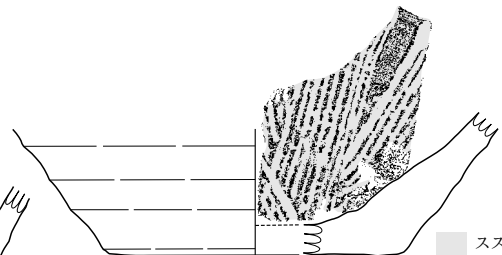
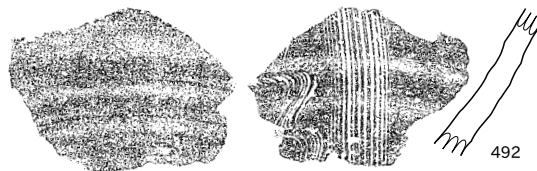
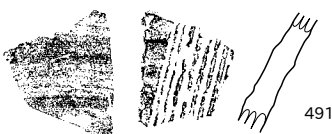
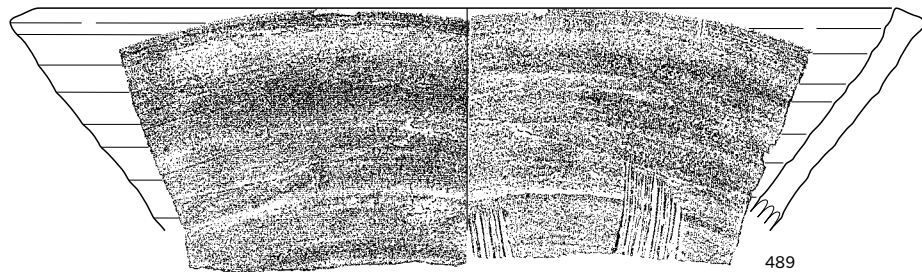
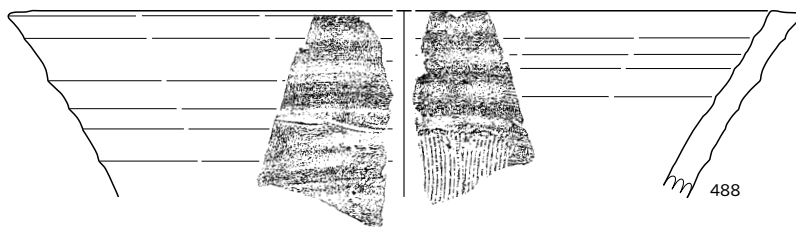
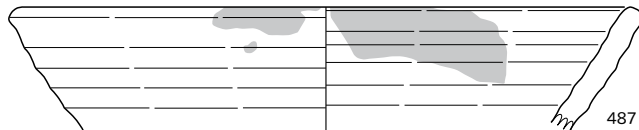
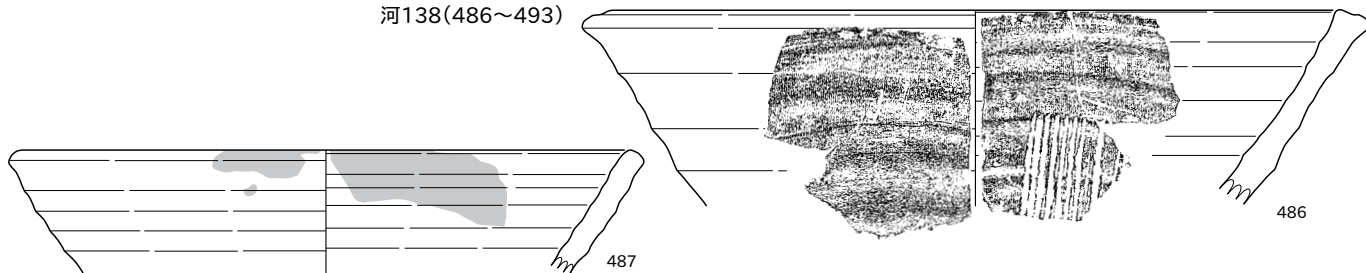

スス

河138(494~504)

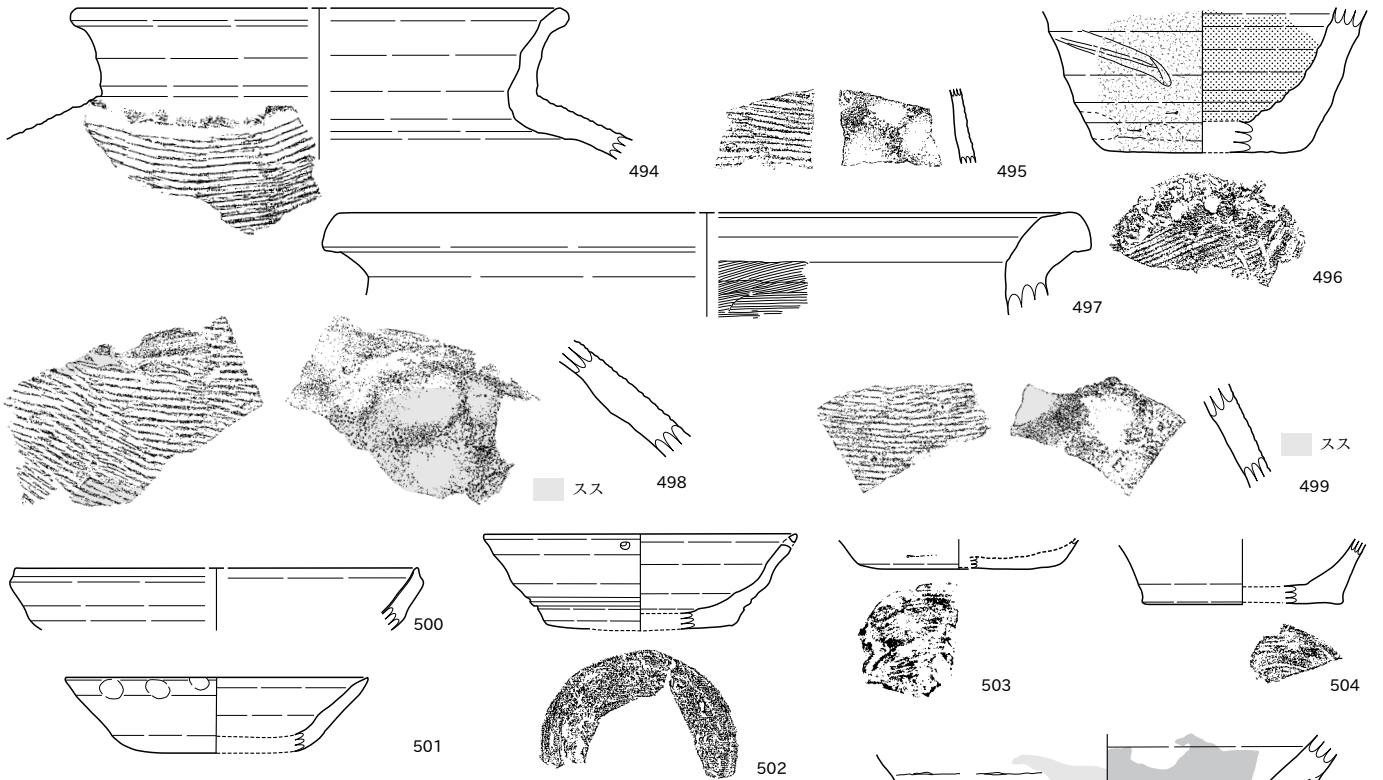

暗渠 (505・506)

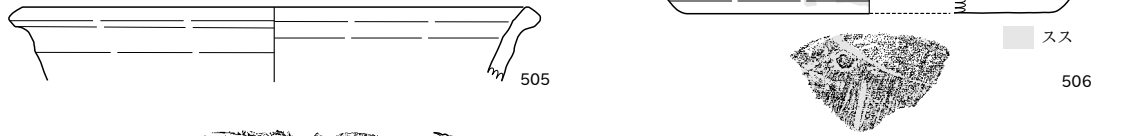

攪乱 (507~513)

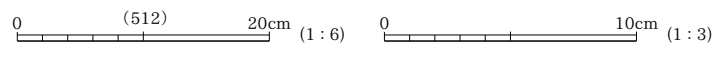
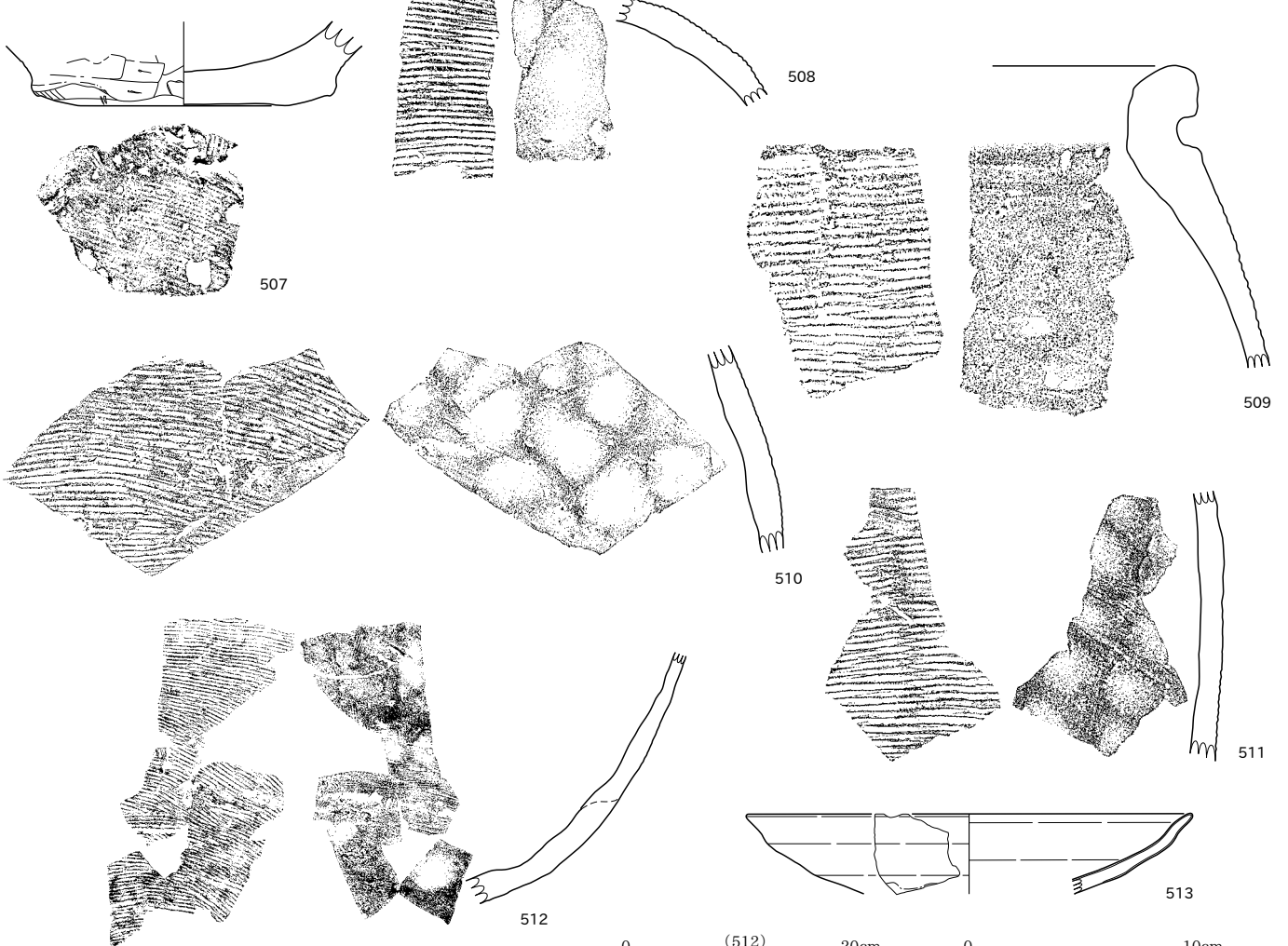

攪乱(514~517)

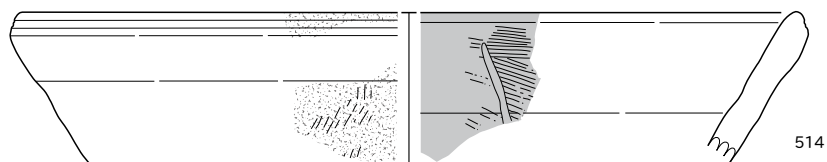

514

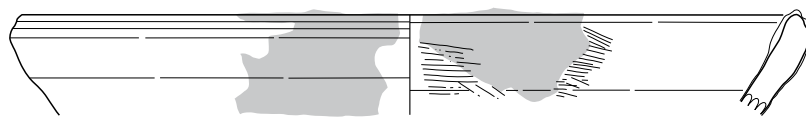

515



516

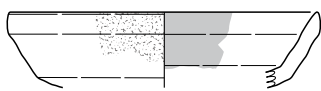

517

表採(518)

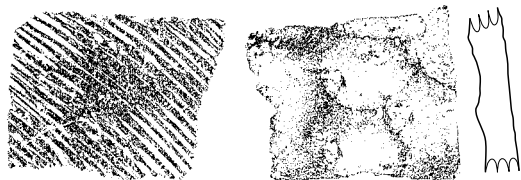

518

立会表採(519~521)

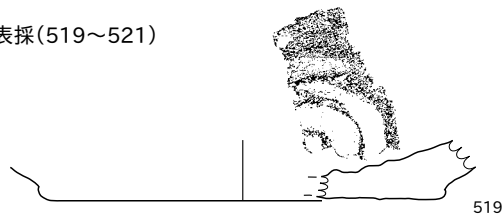

519

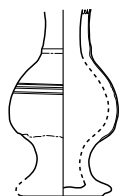

520



521

54T(522)

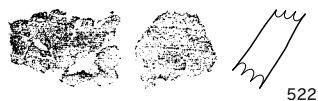

522

64T(523)



523

SD157(1~4)

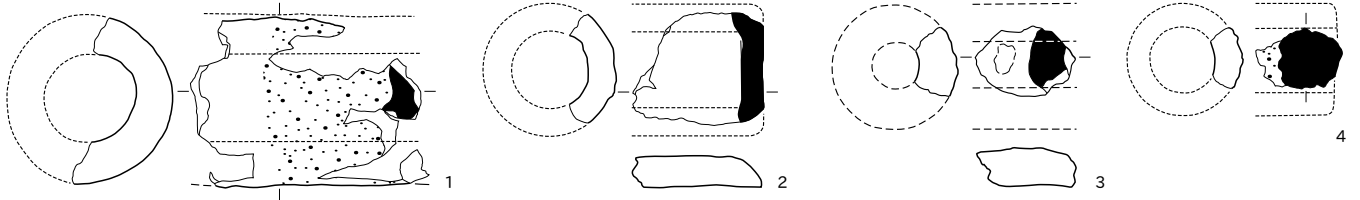

SD155(5~6)

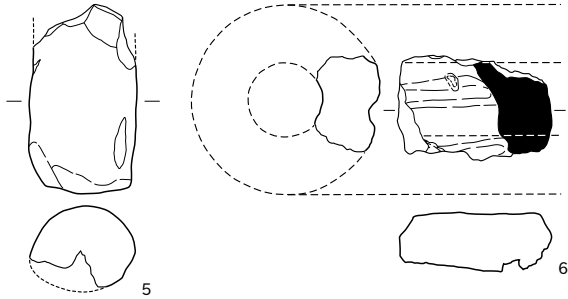

SD156(7)

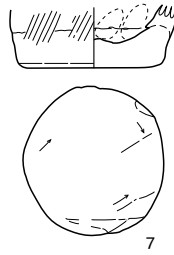

SE917(8)

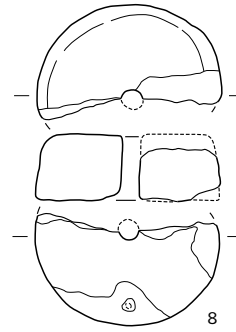

SK1327(9)

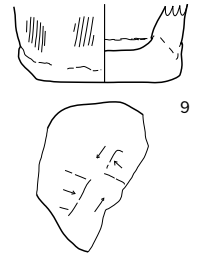

SK1115(10)

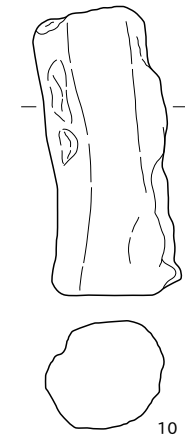

SK1310(11)

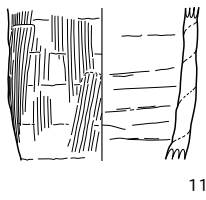

SX841(12)

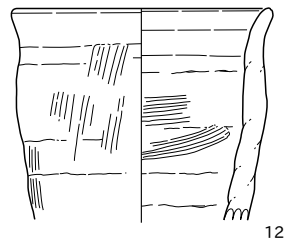

SX1219(13)

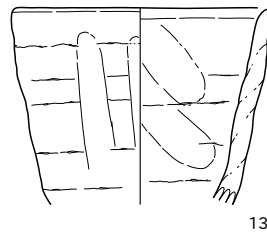

SX473(14)

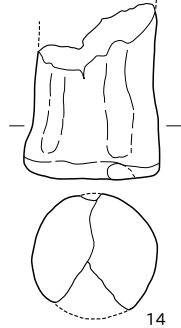

SX945(15~29)

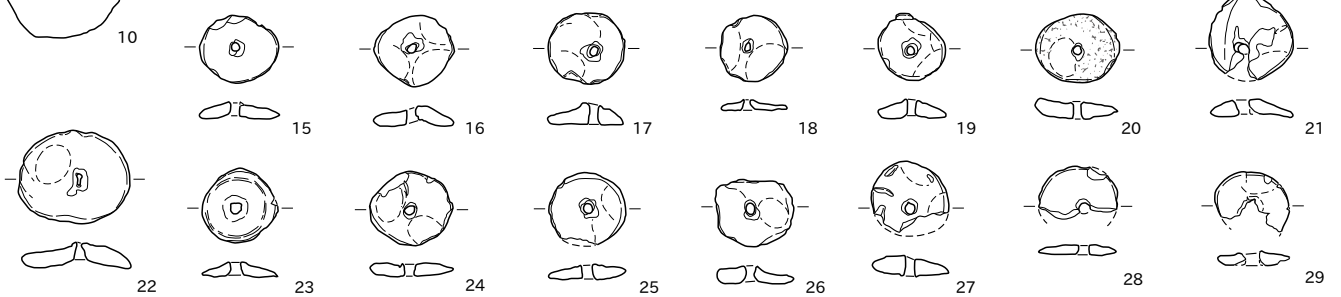

河138(30~35)

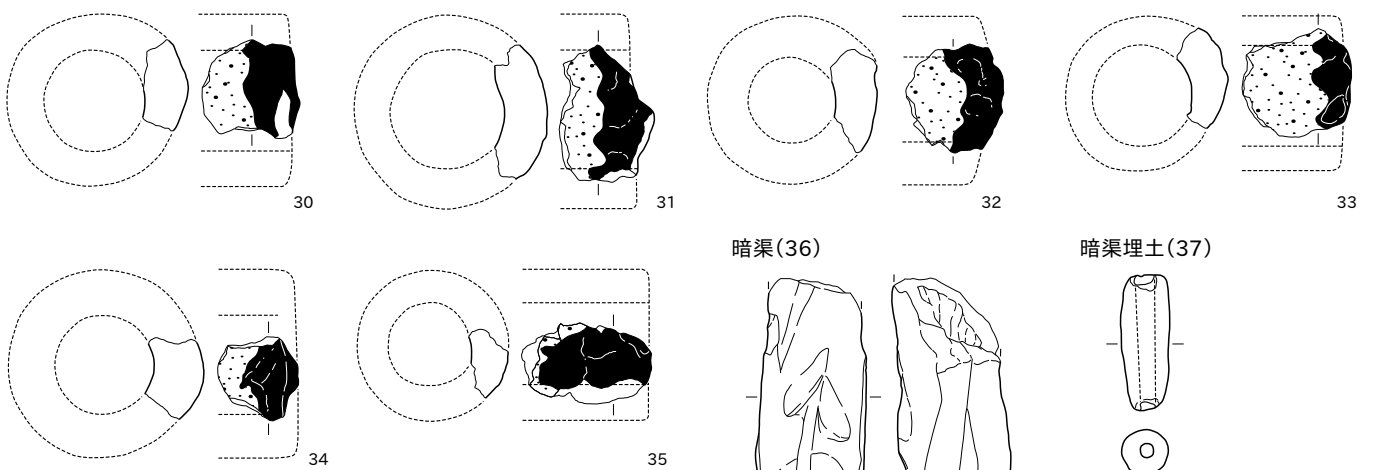

暗渠(36)

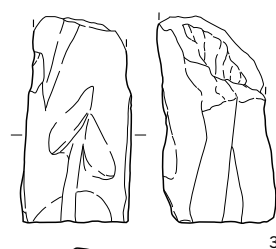

暗渠埋土(37)

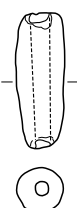

3J-41(1)

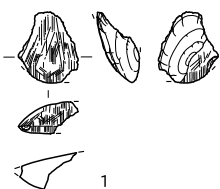

SB1568P4(2)

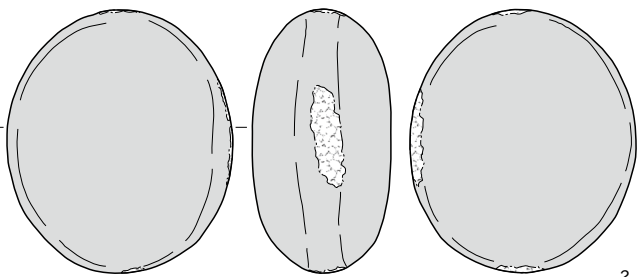

Pit92(3)

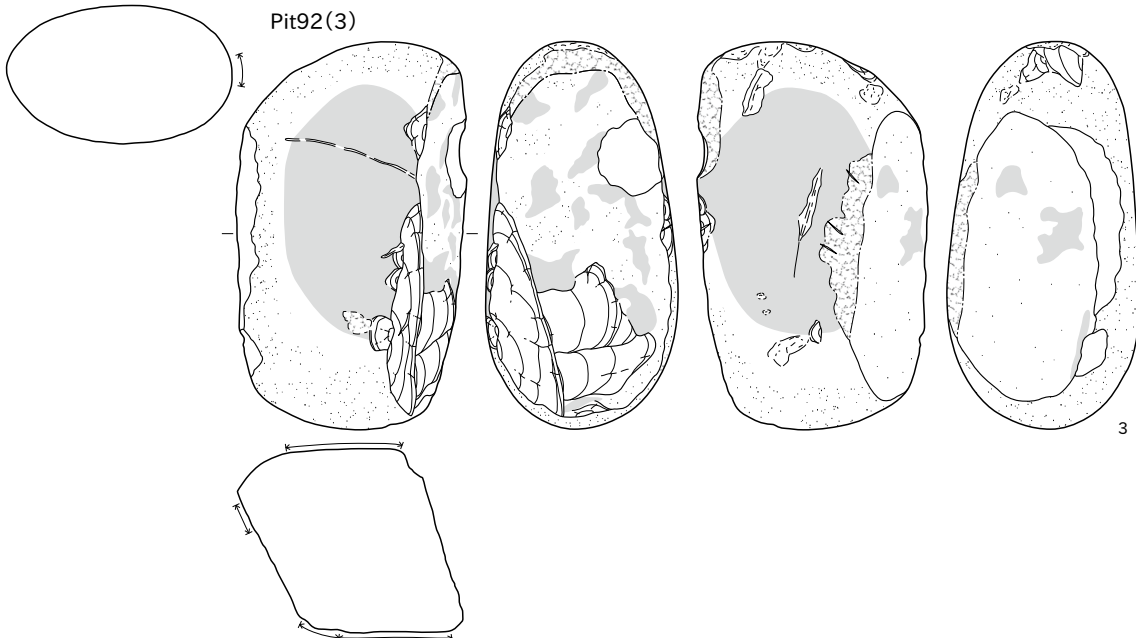

Pit778(4)

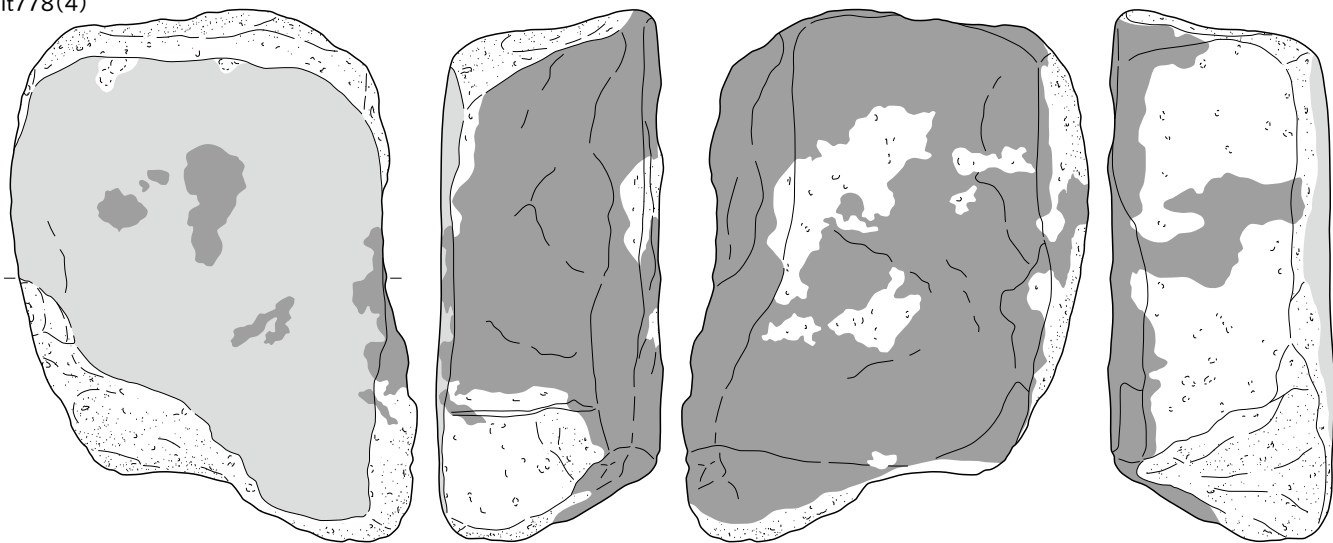

Pit717(5)

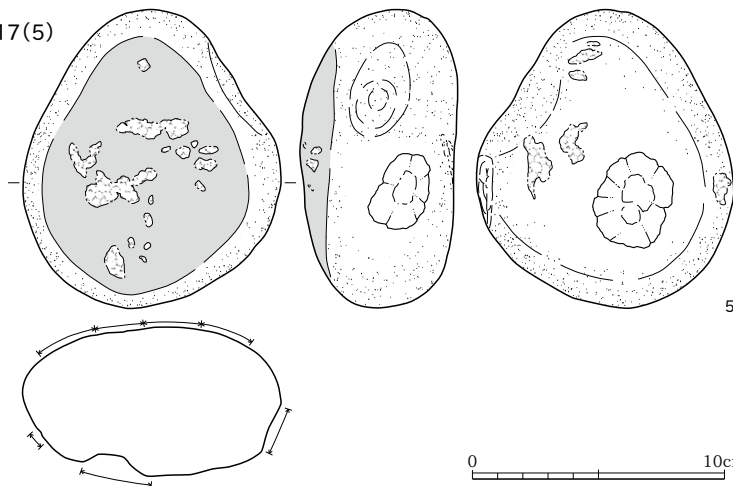

■ アスファルト

0 10cm (1:3)

Pit861(6)

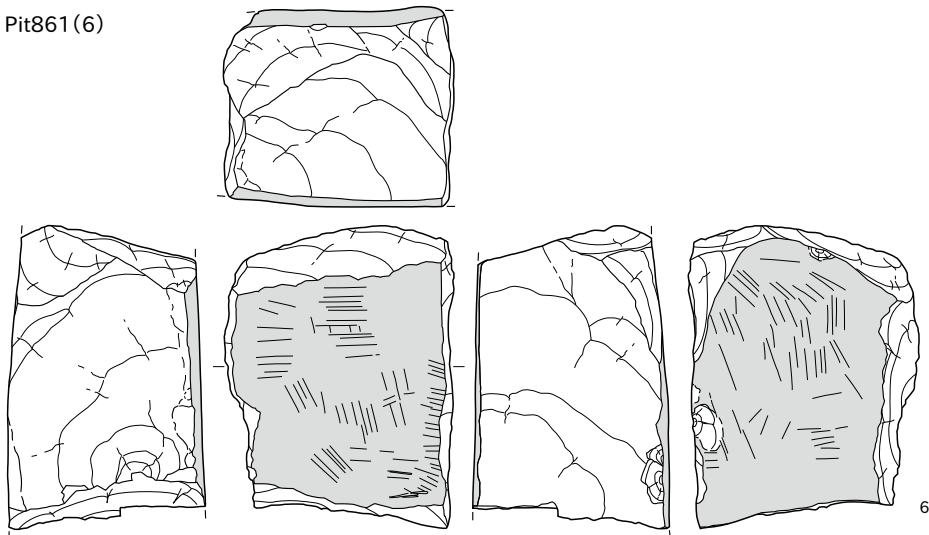

Pit1510(7)

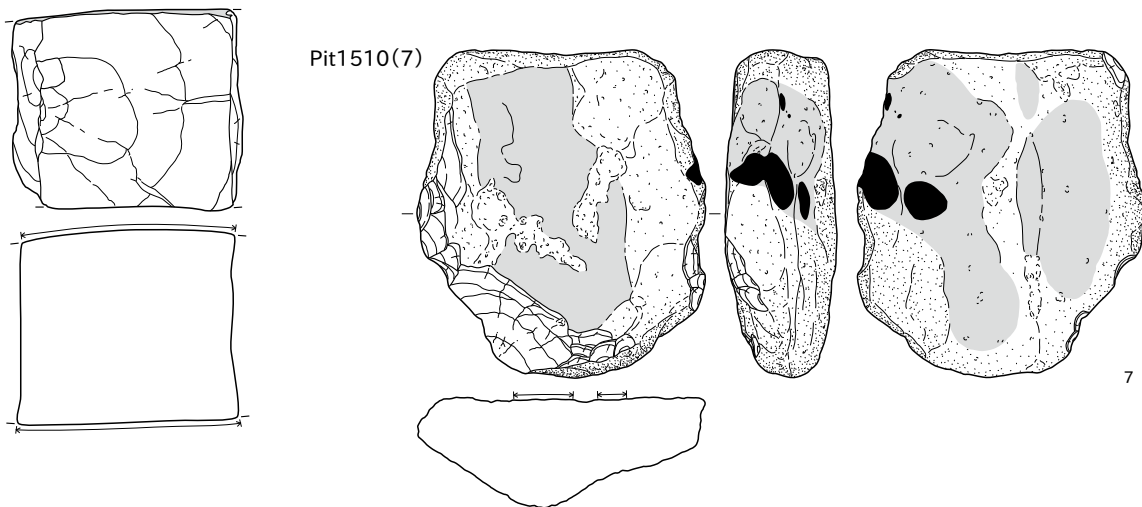

SD158(8~11)

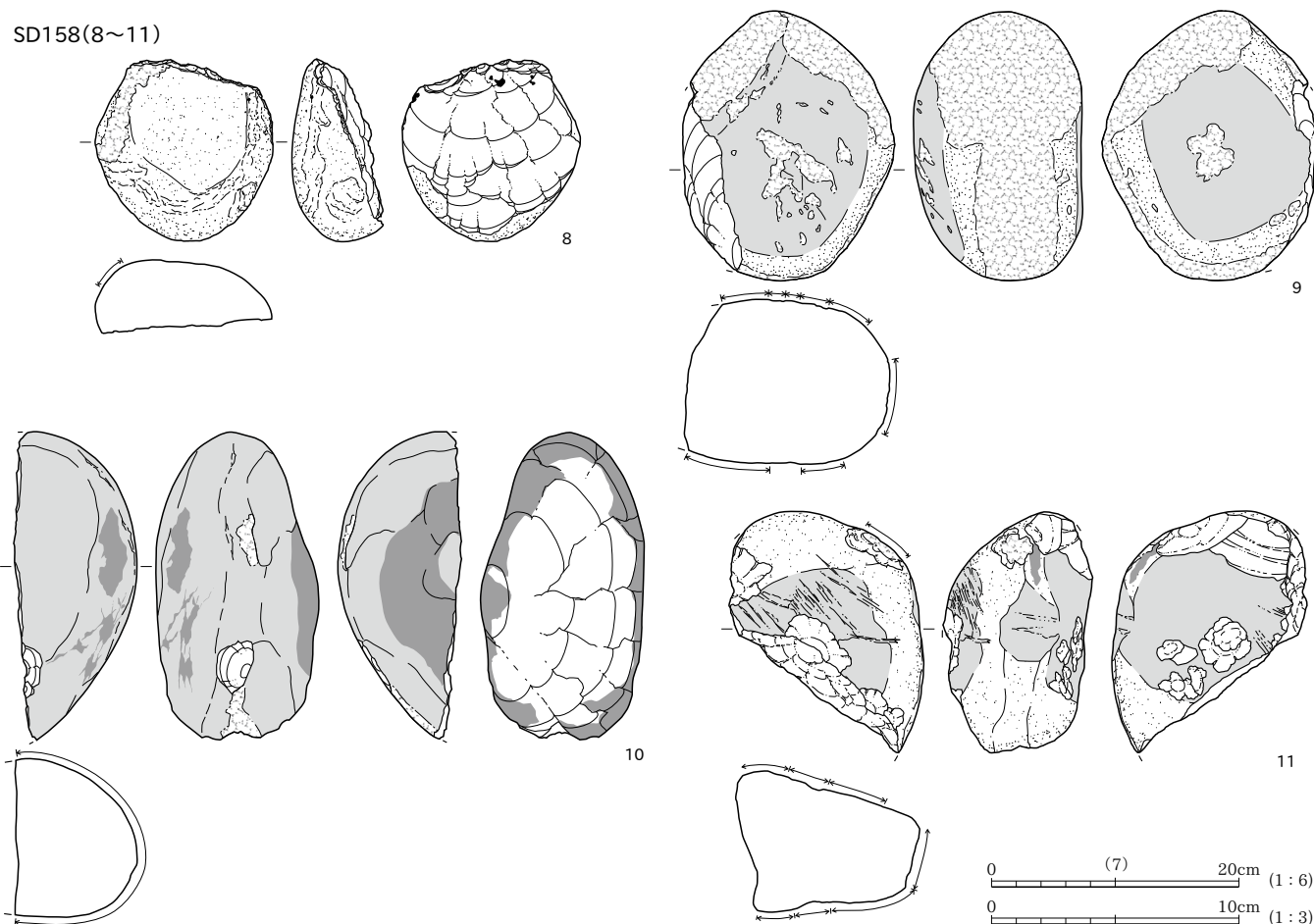

SD158(12)

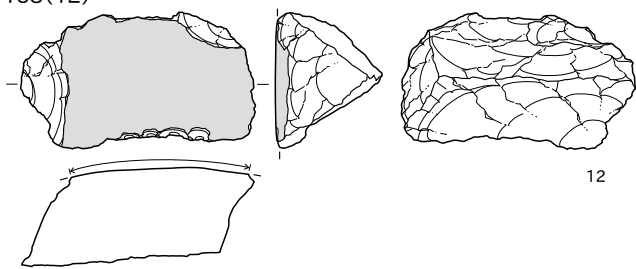

12

SD156(13)

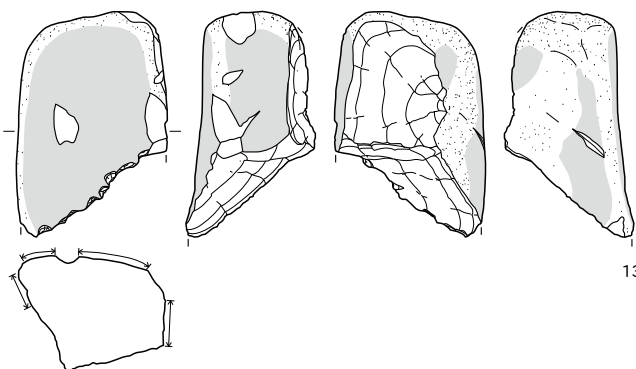

13

SD155(14~22)

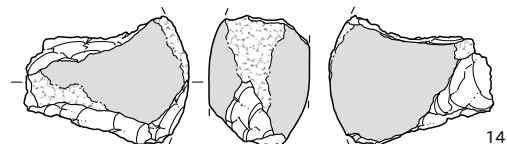

14

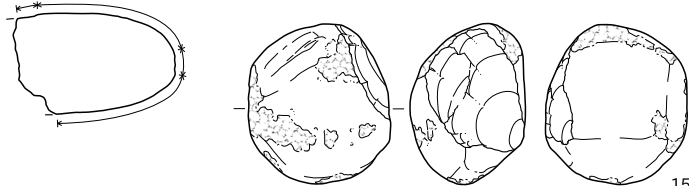

15

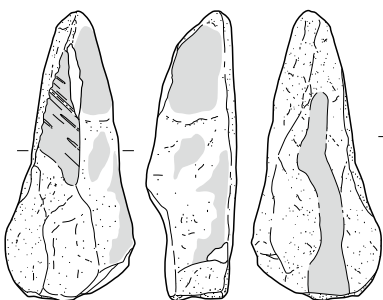
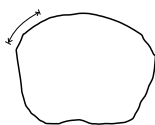

16

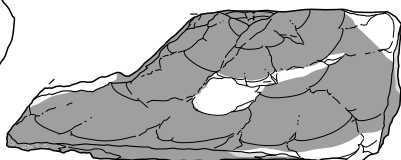

18



19

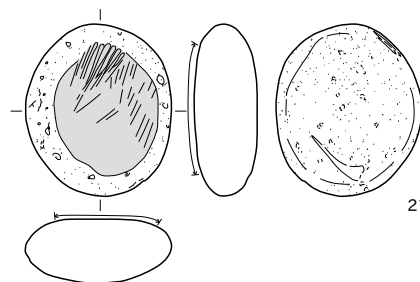
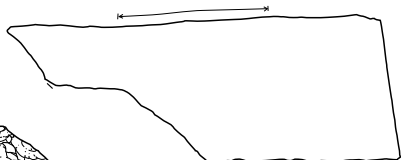

21

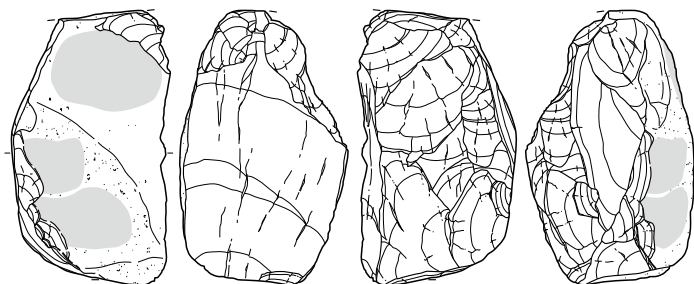

20

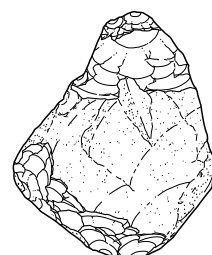
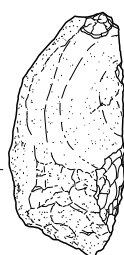
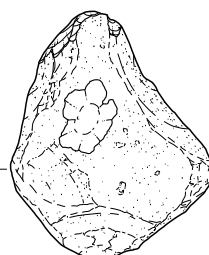

22

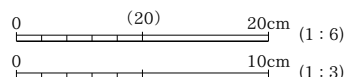
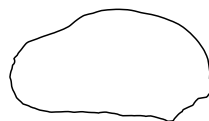
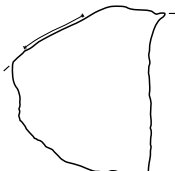

SD154(23・24)

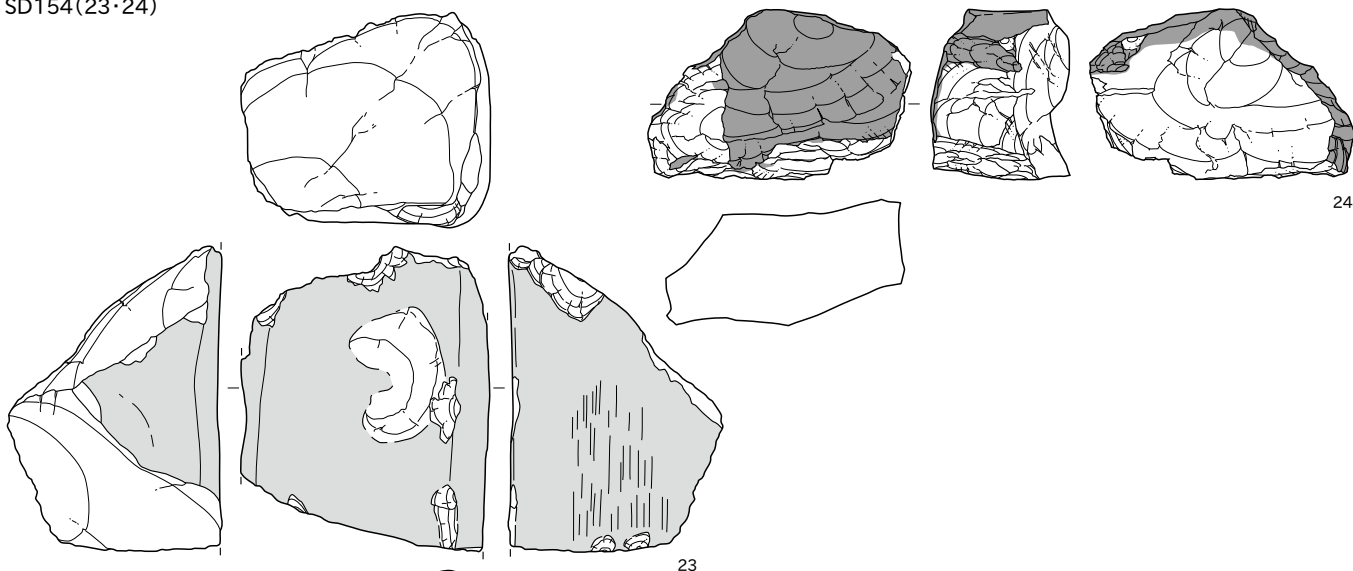

23

24

SE89(25・26)

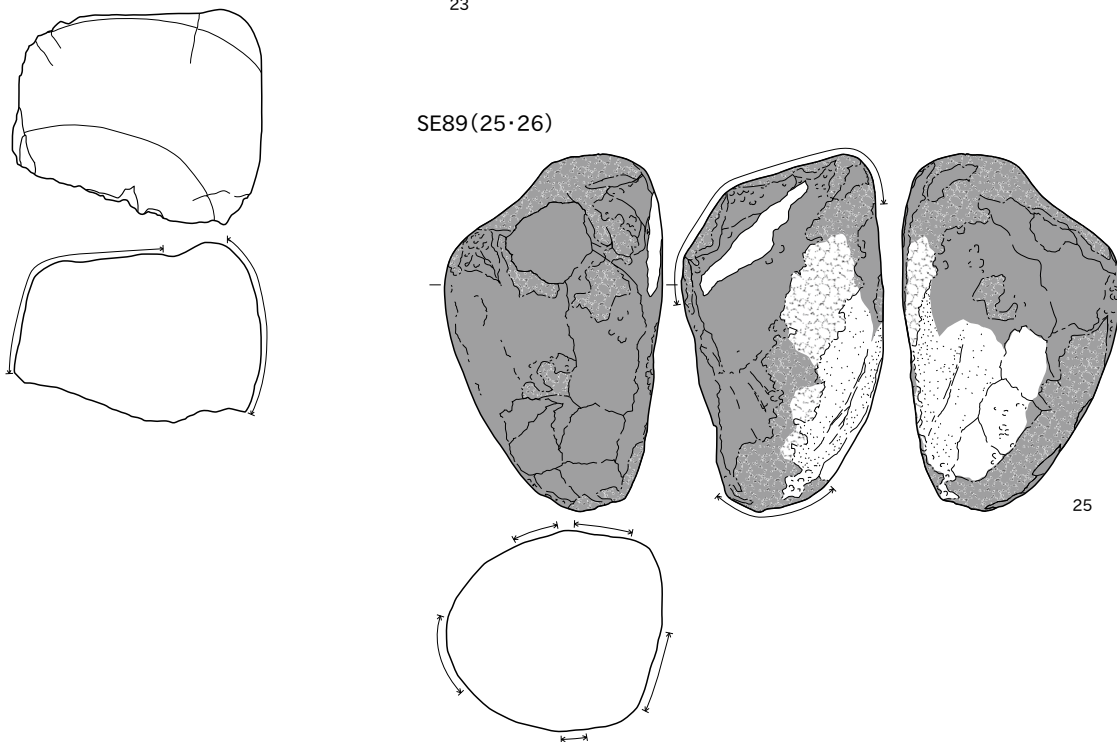

25

26

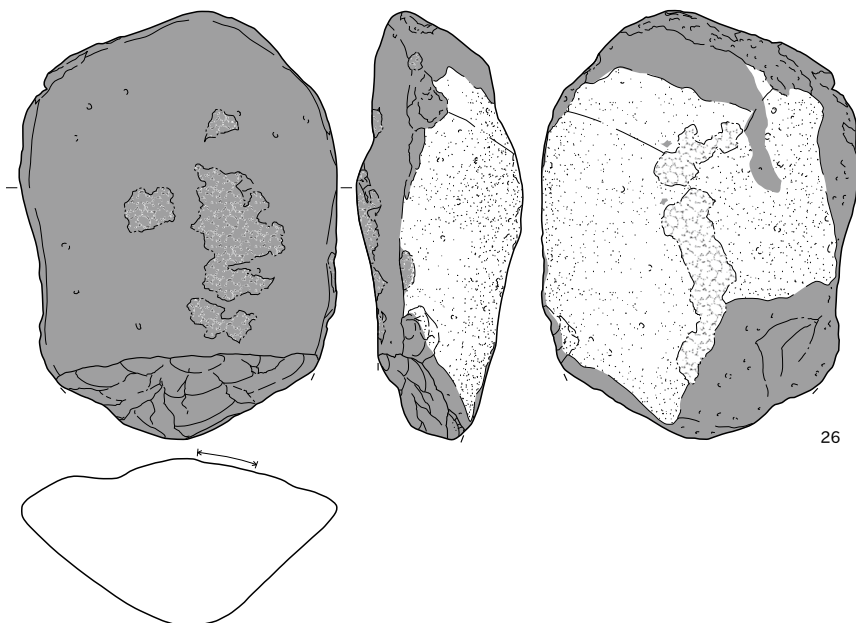

SE89(27・28)

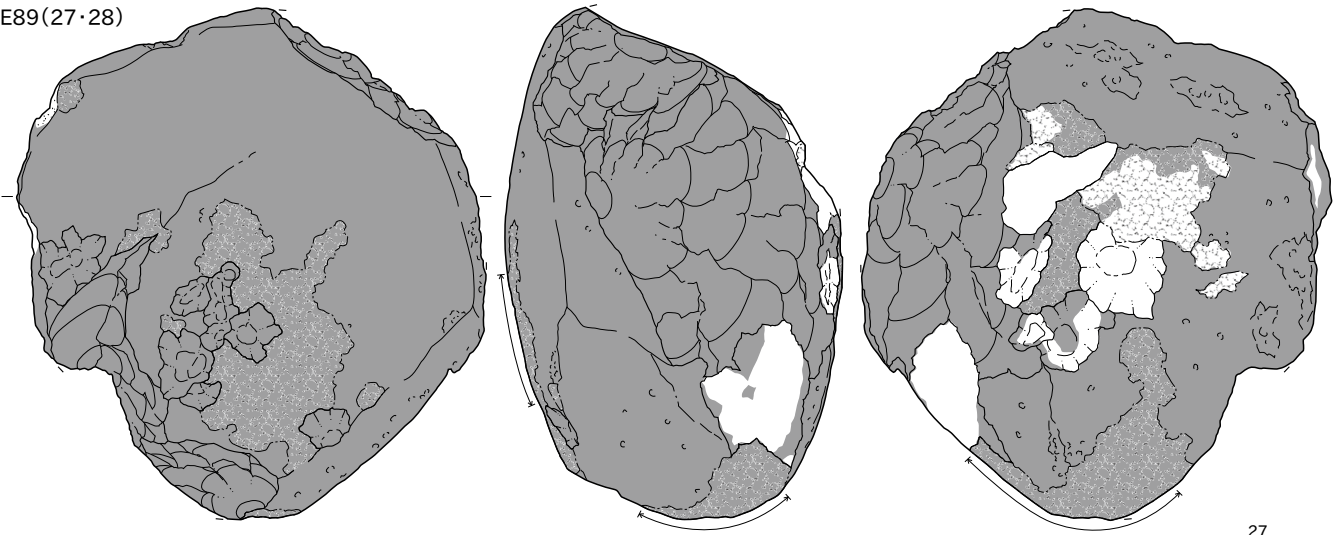

27

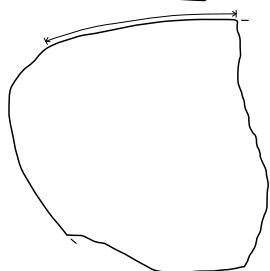
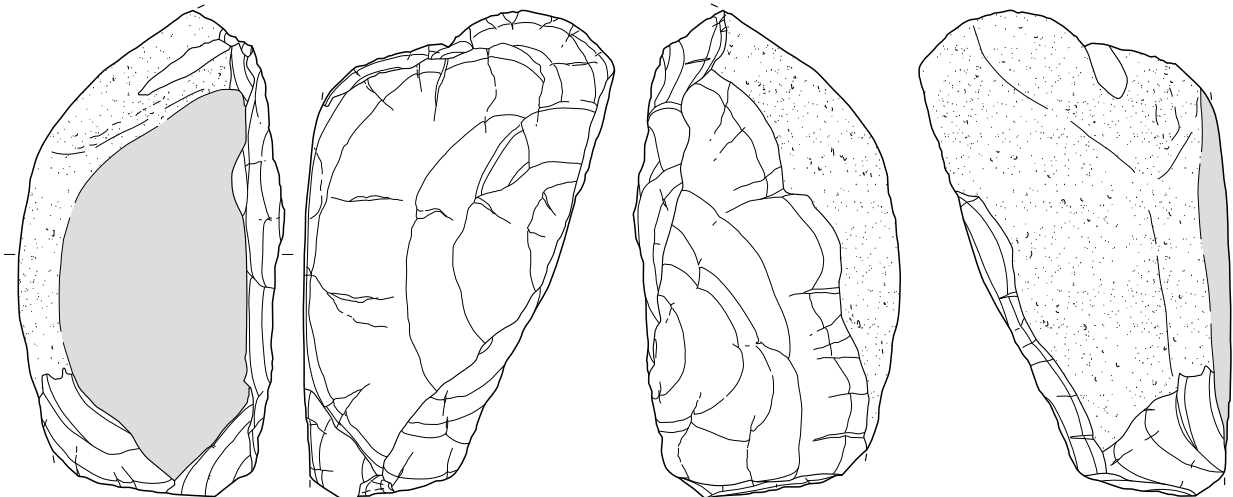
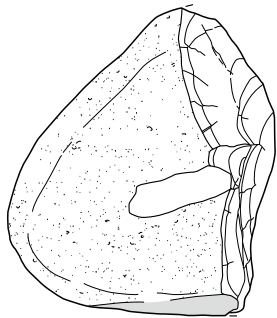
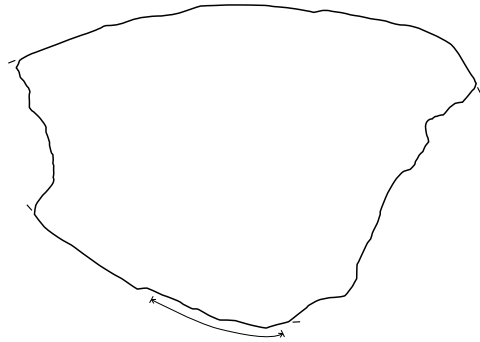

28

SE80(29・30)

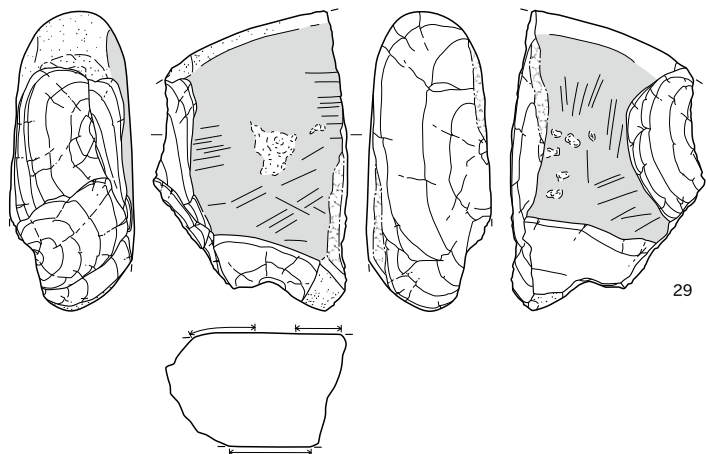

SE57(31~33)

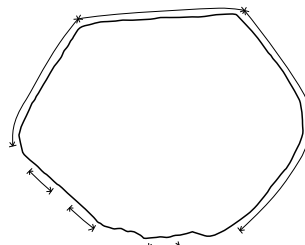
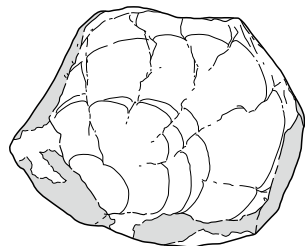
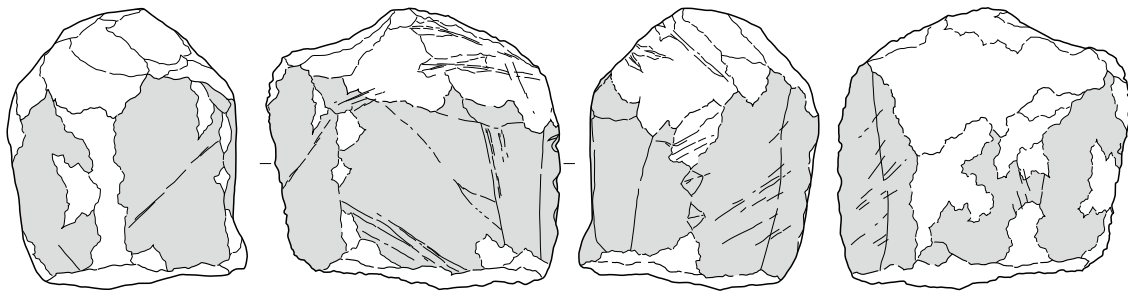
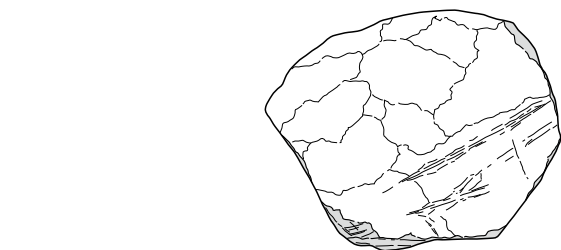
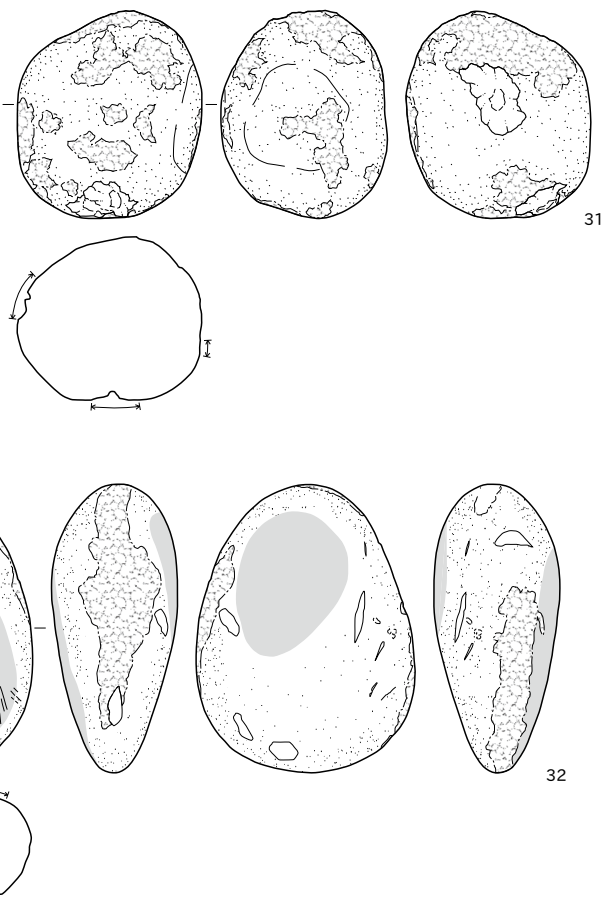

0 (30) 6cm (3:4)

0 10cm (1:3)

SE588(34)

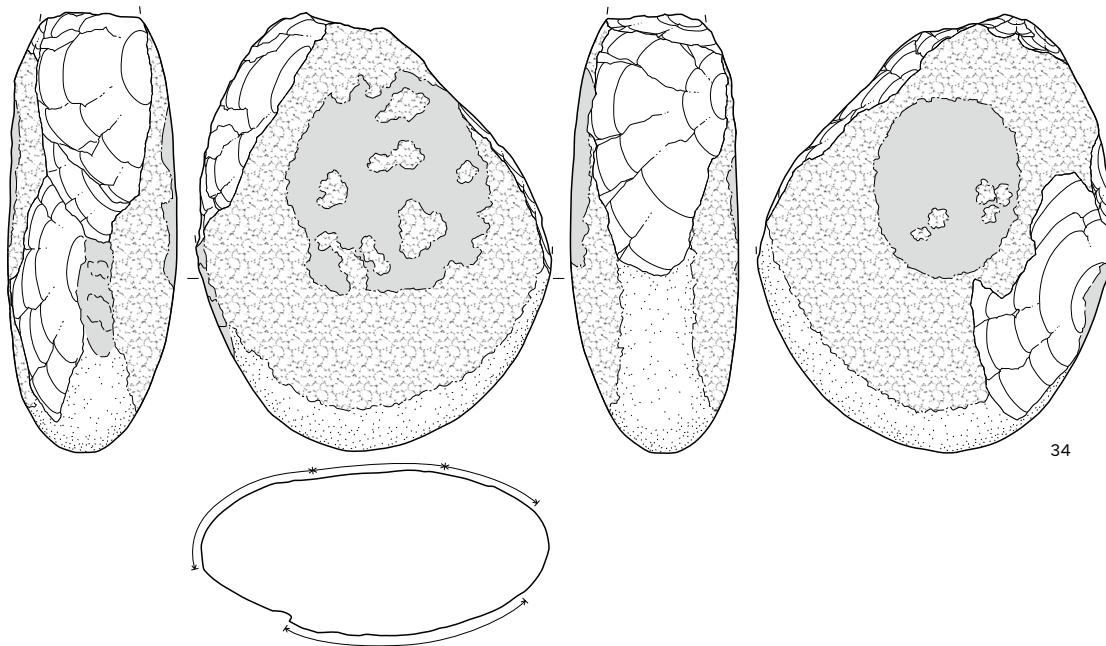

34

SE709(35)



35

SE709(36~38)

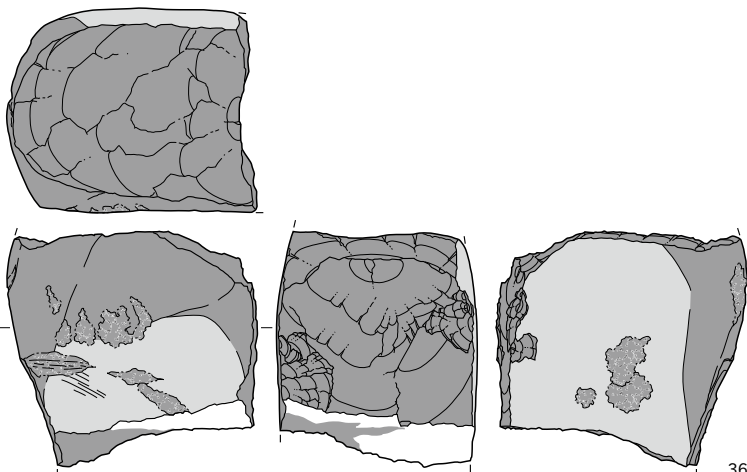

36



37

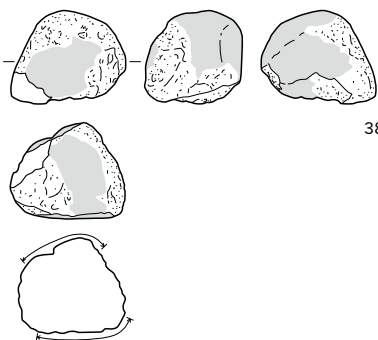
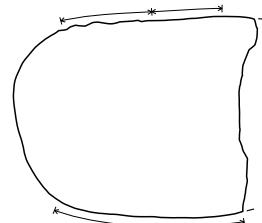
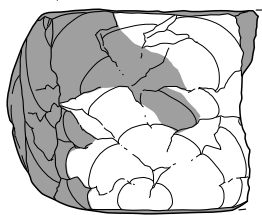

38

SE912(39)

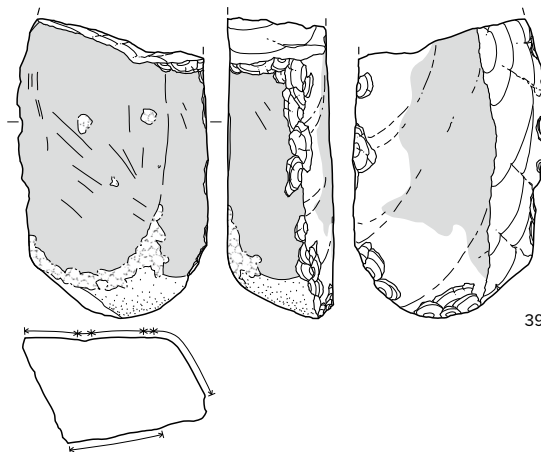

39

SE798(40)

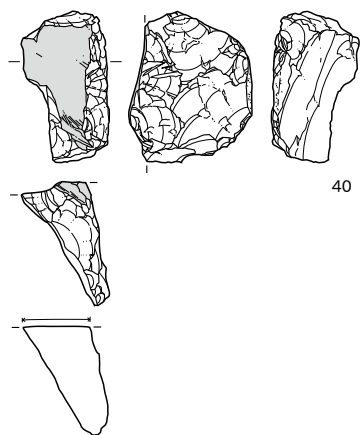

40

SE1070(41)

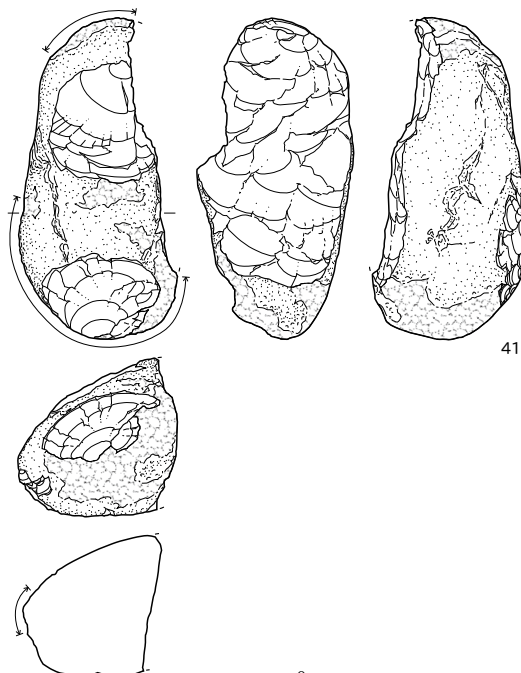

41

SE1070(42)

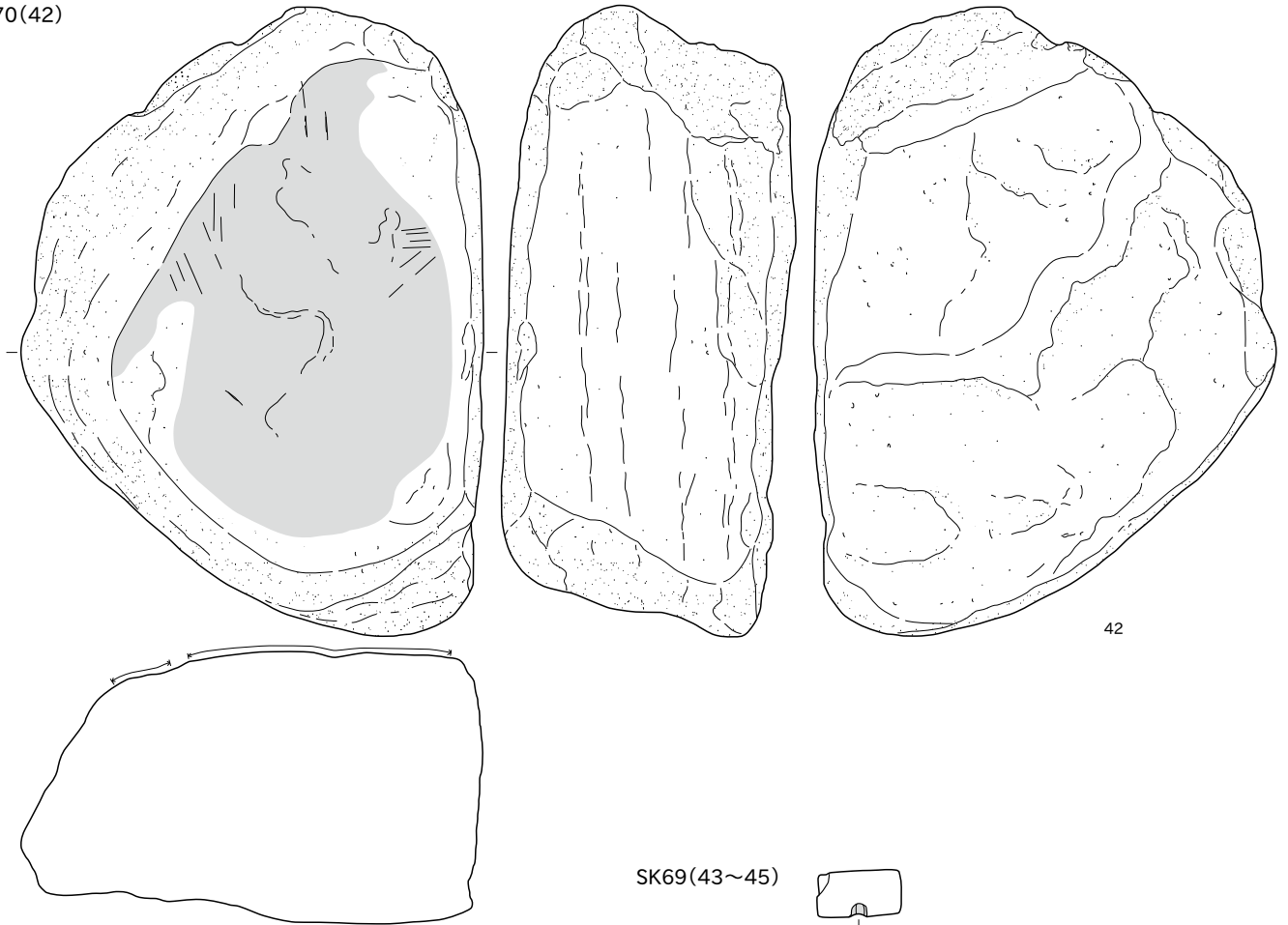

SK69(43~45)

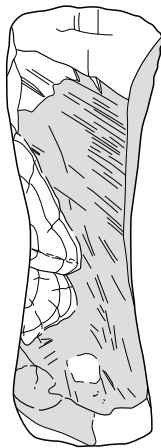
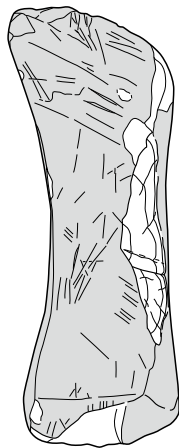
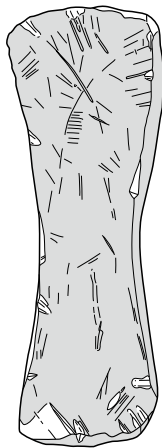
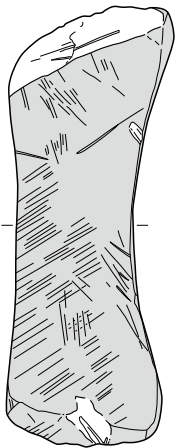
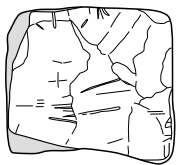
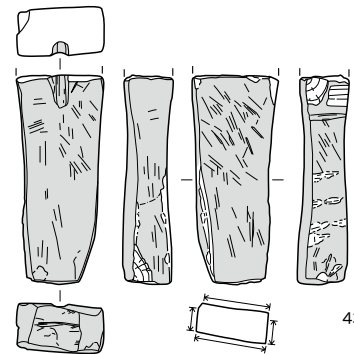

44

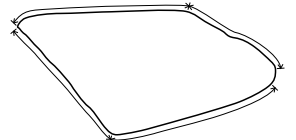
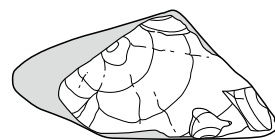
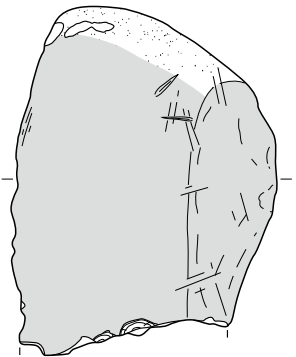
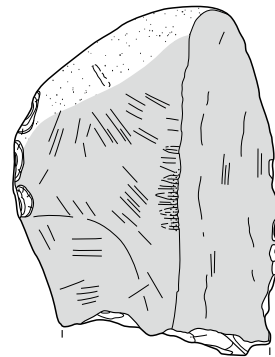
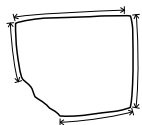
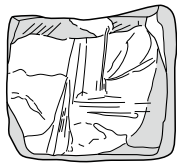

45

SK741 (46)

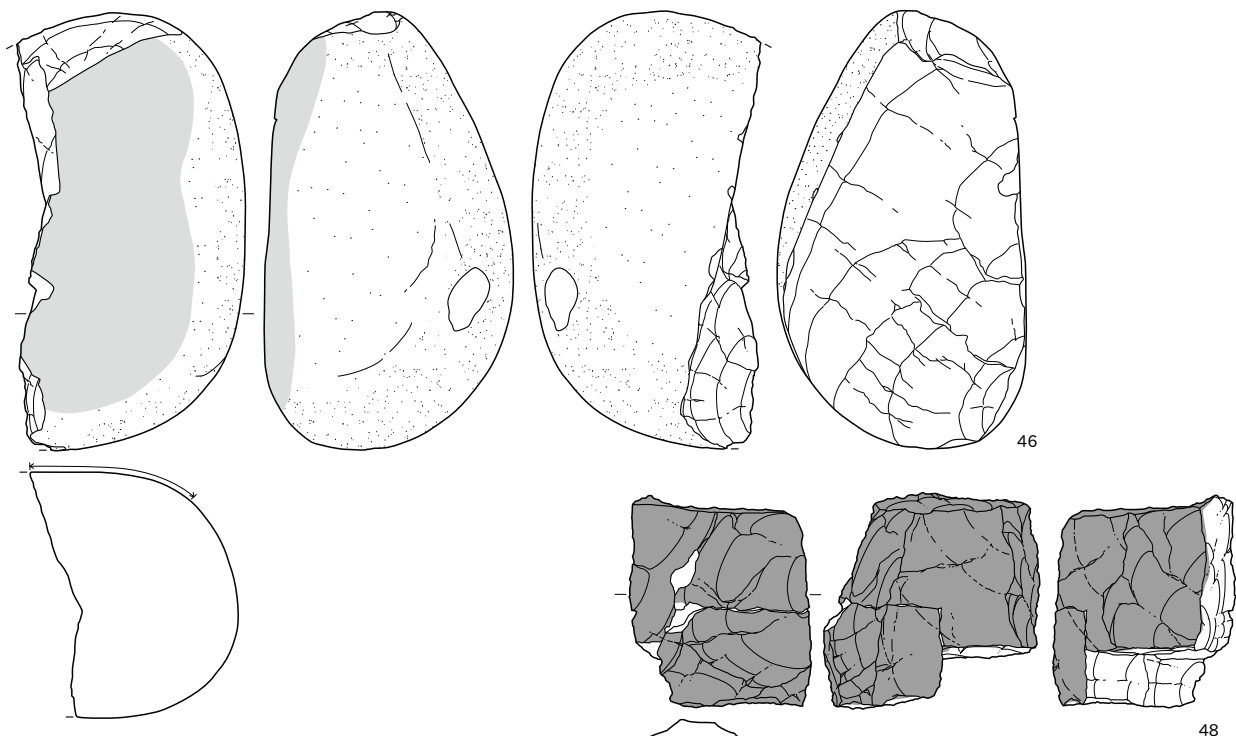

SX227 (47~49)

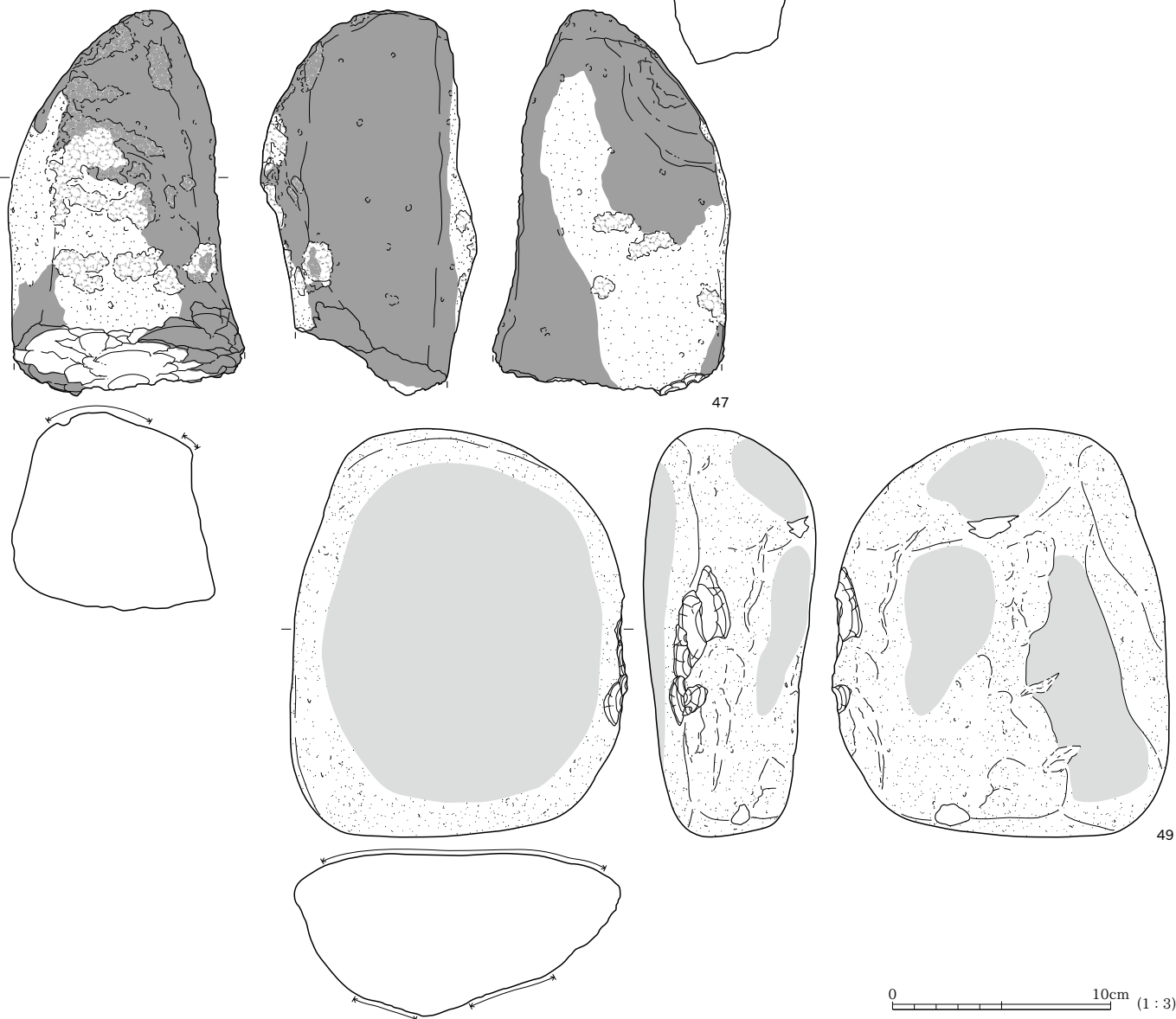

SX1020(50)

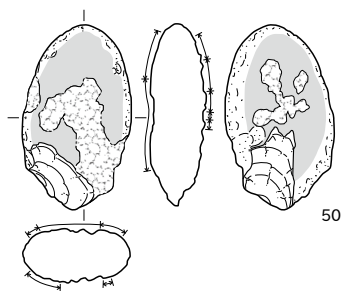

50

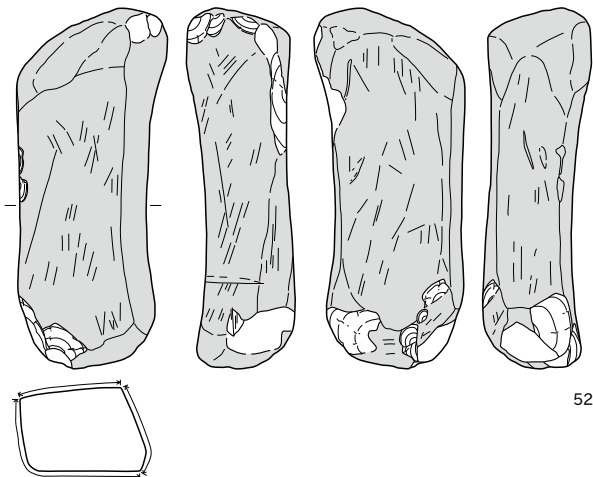

52

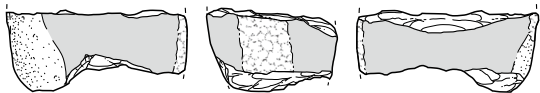
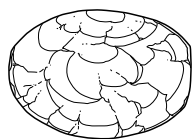

54

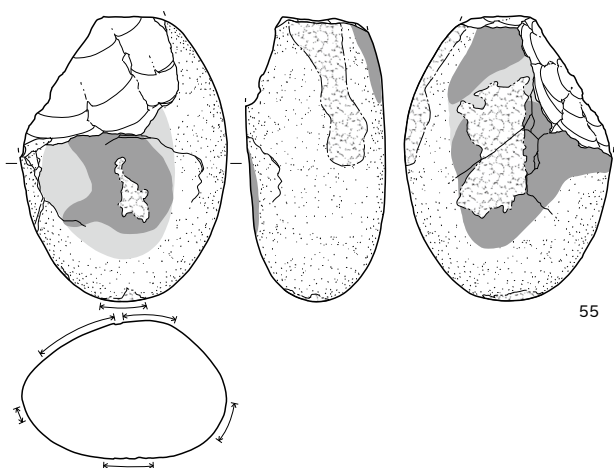
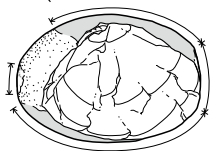

55

SX473(51-52)

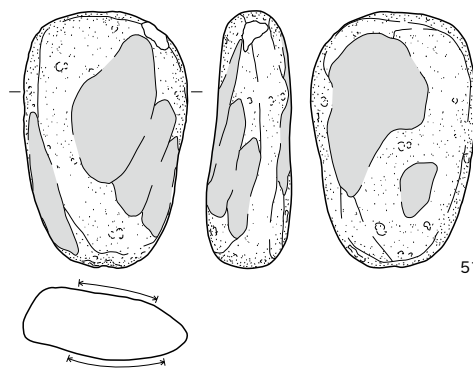

51

SX946(53~56)

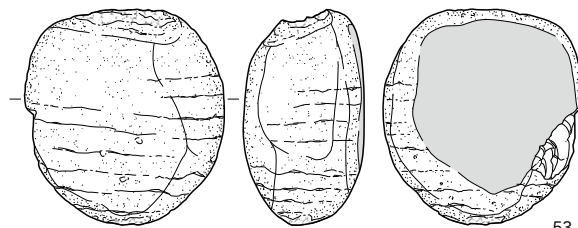
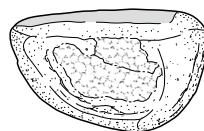

53

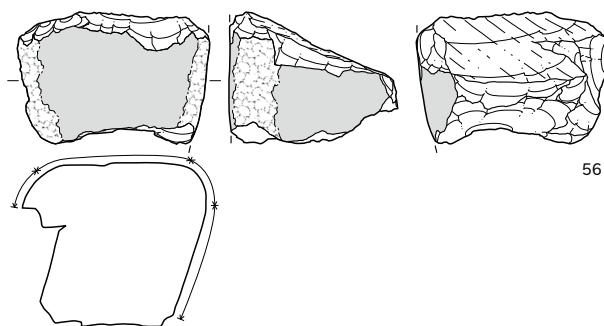
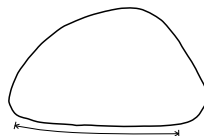

56

SX946(57)

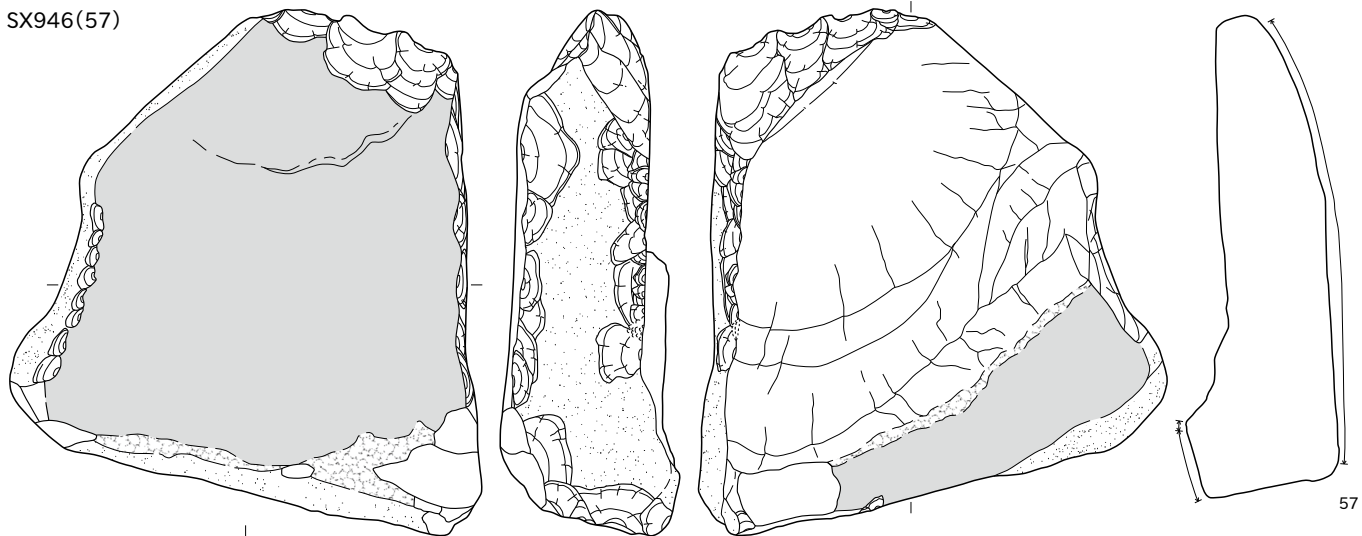

57

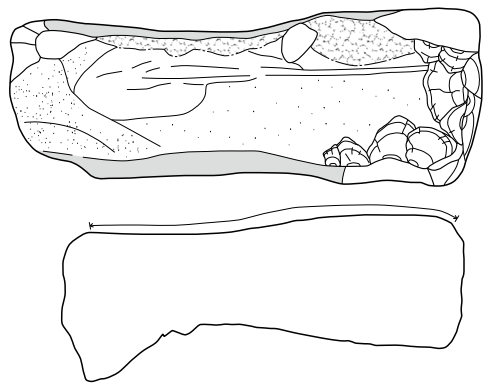

SX945(58)

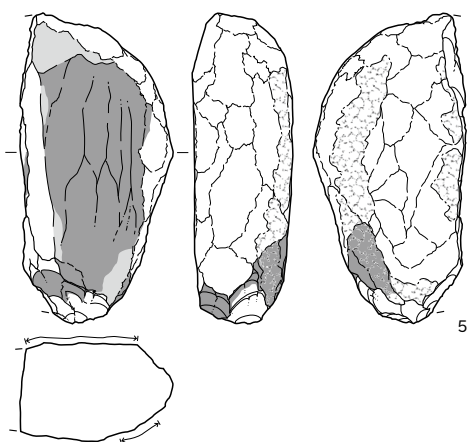

58

包含層 3J-1F(59)

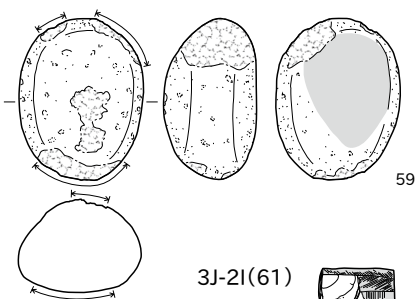

59

3J-2I(61)

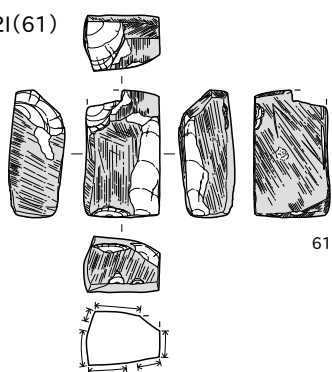

61

3K-1A(60)

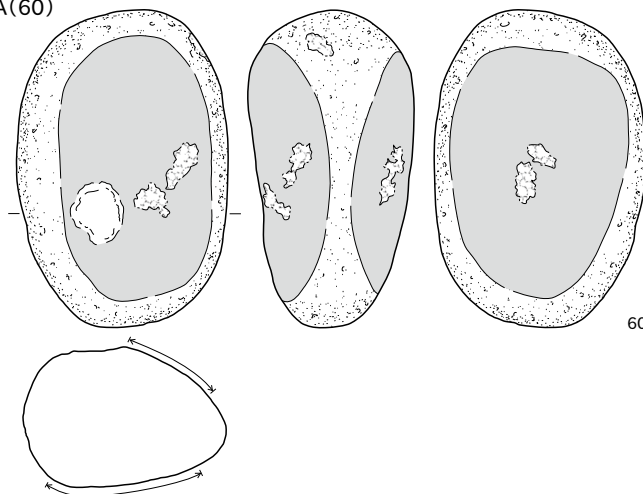

60

3J-4J(63)

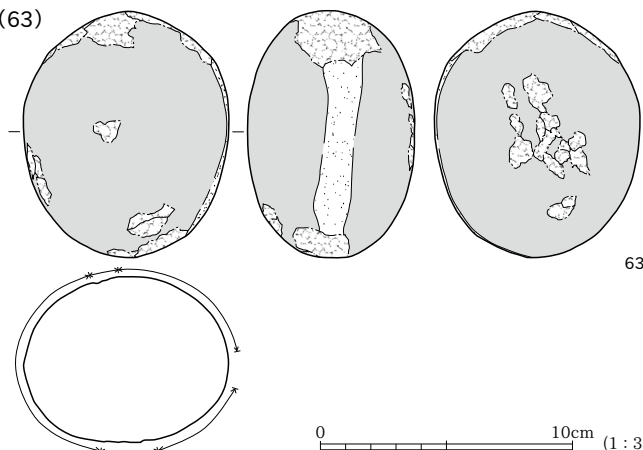

63

3J-3H(62)

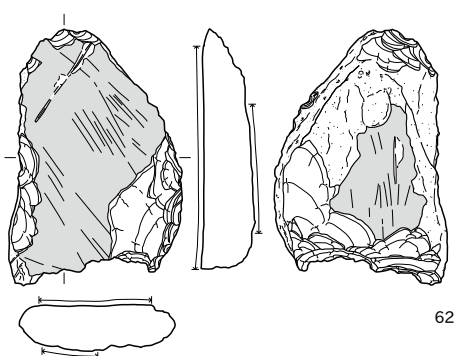

62

3J-4J(64)

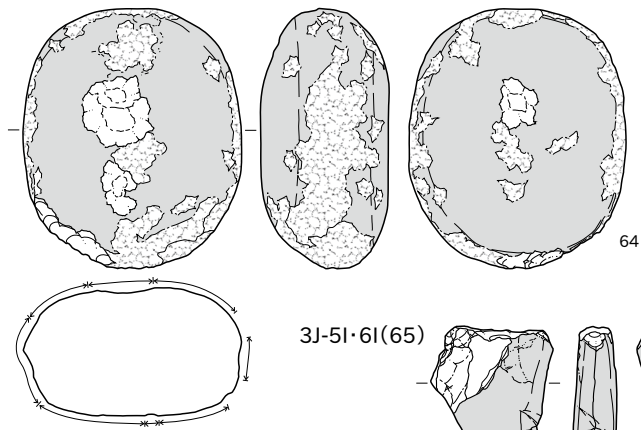

64

3J-5J(66)

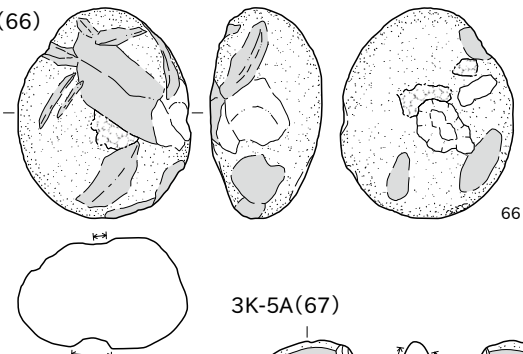

66

3J-5I・6I(65)

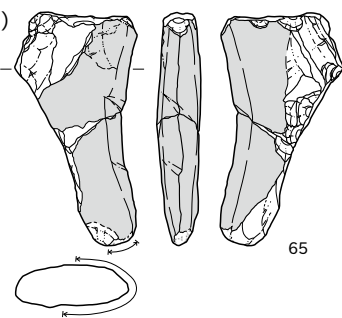

65

3K-5A(67)

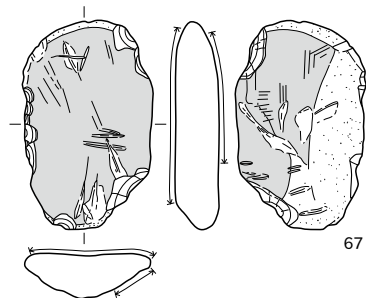

67

3J-9H(68)

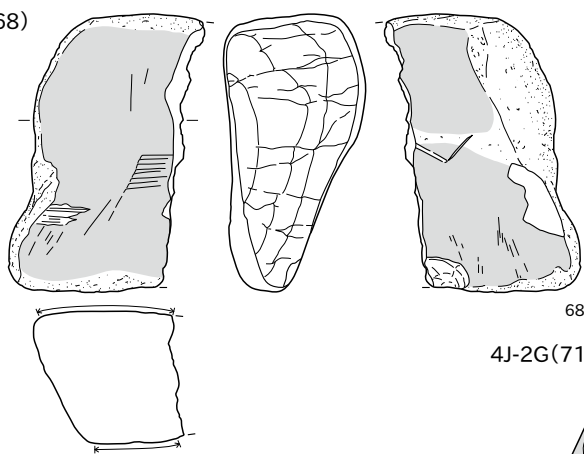

68

3J-10D(69)

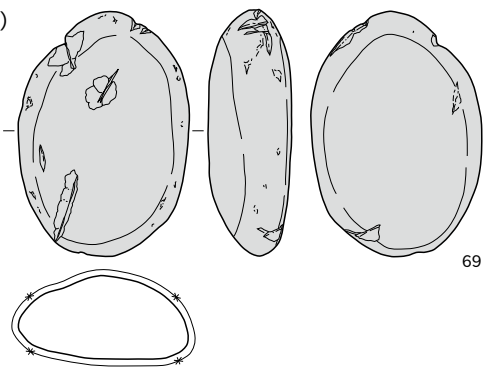

69

4J-2G(71)

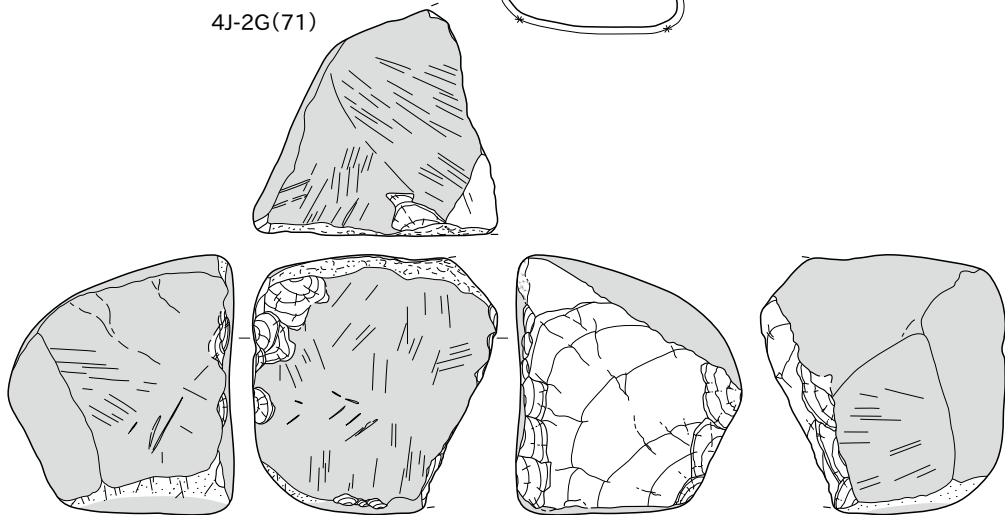

71

4J-1F(70)

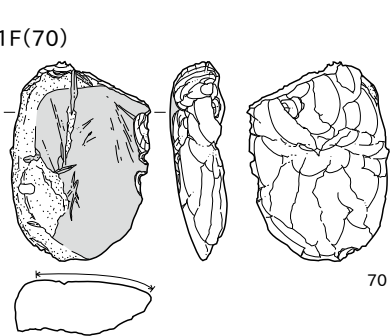

70

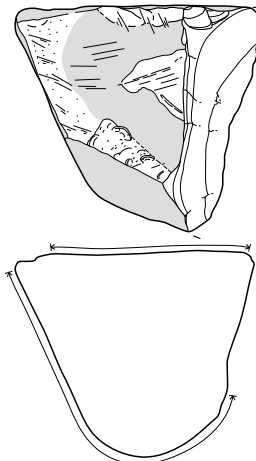

4J-3D(72)

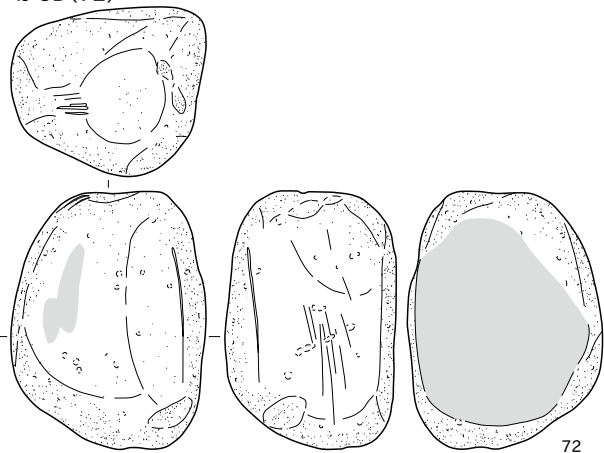

72

4J-3E(73・74)

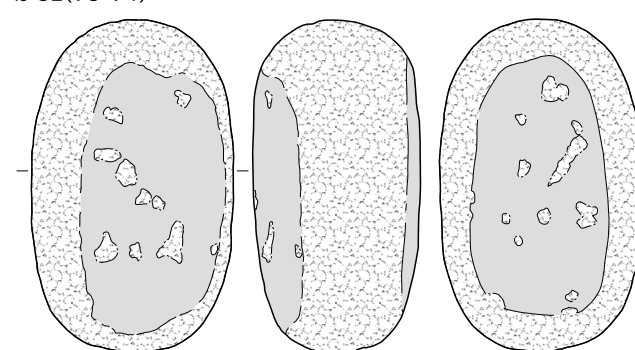

73

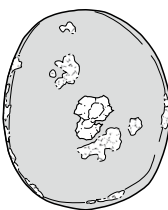
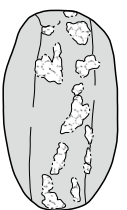
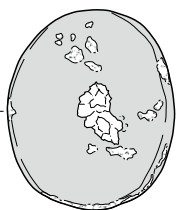
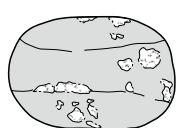
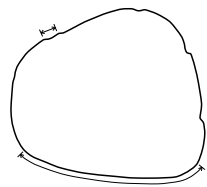
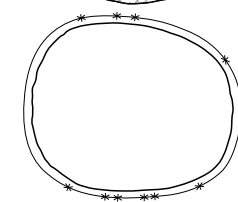

74

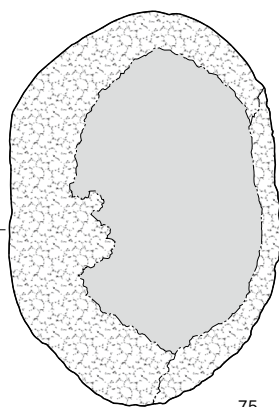
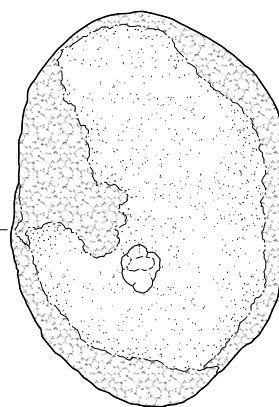
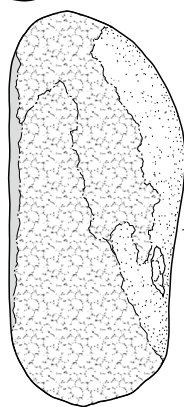
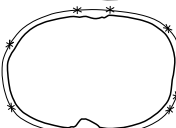
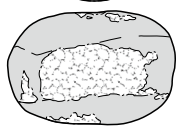

75

4J-4C(75~77)

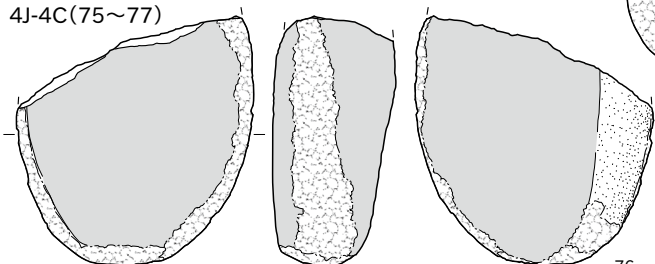

76



河138(78)

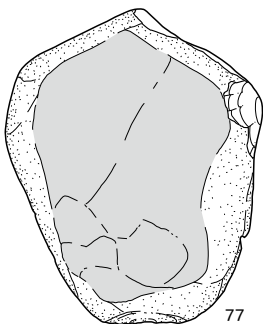
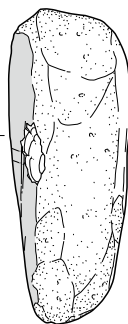
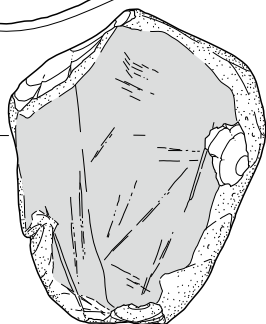
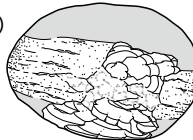

77

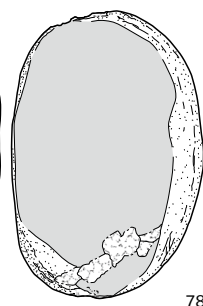
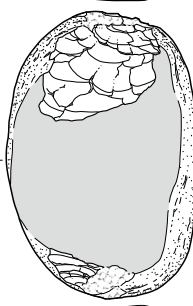

78

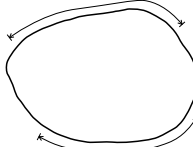
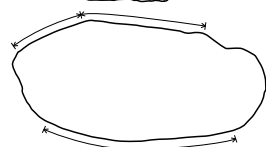

河138(79~86)

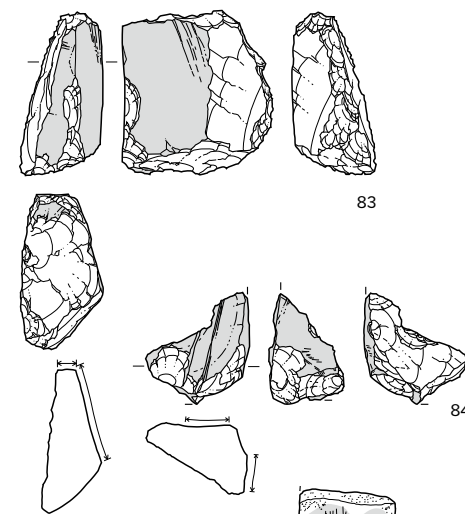
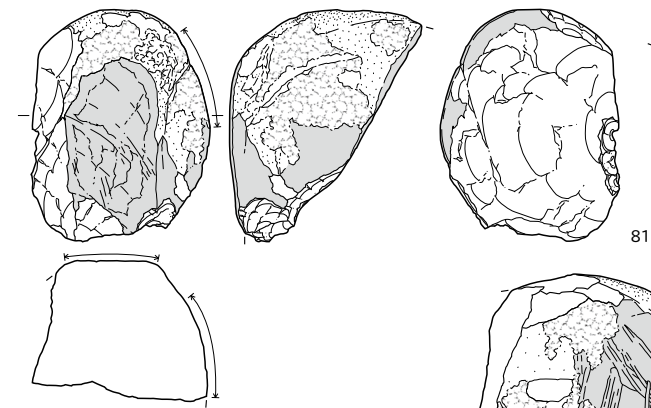
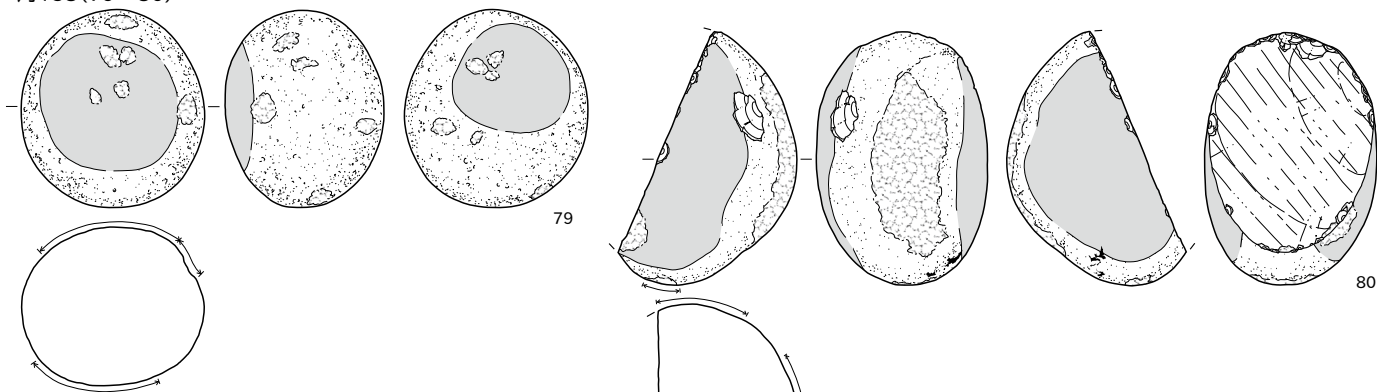

南谷部(87)

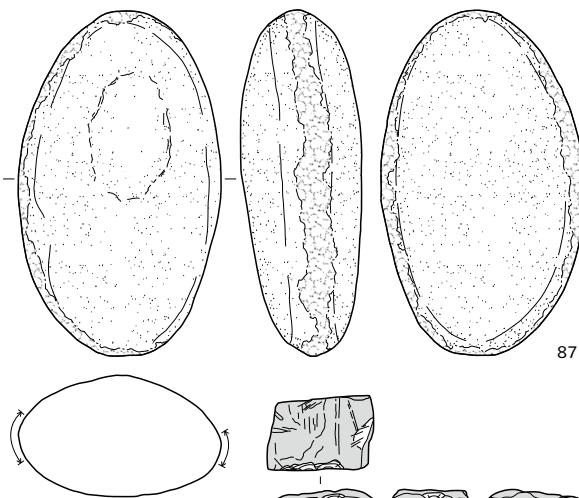

攪乱(88~89)

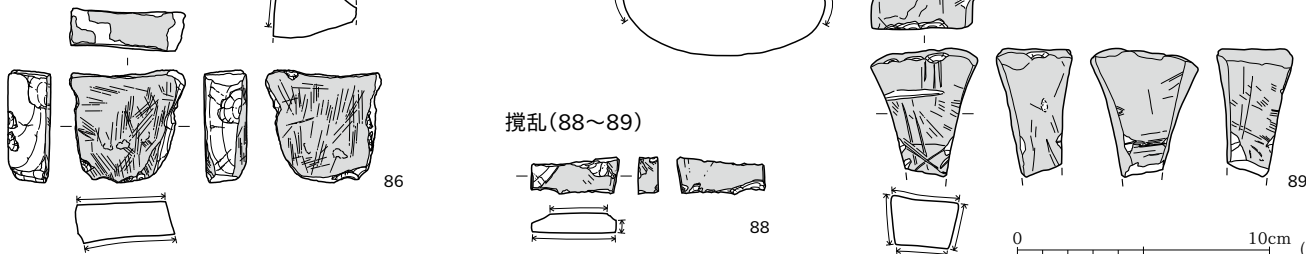

SA1544P3(1)

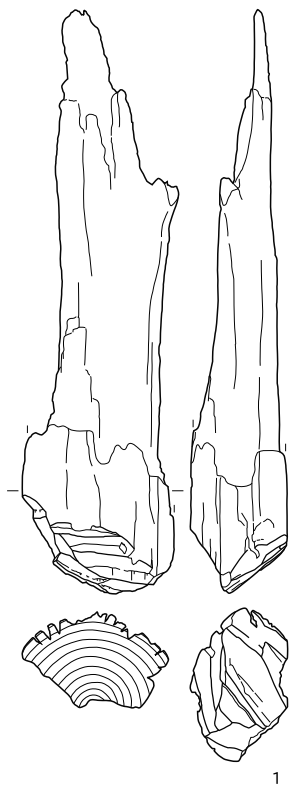

SA1546P2(2)



SA1547P2(3)

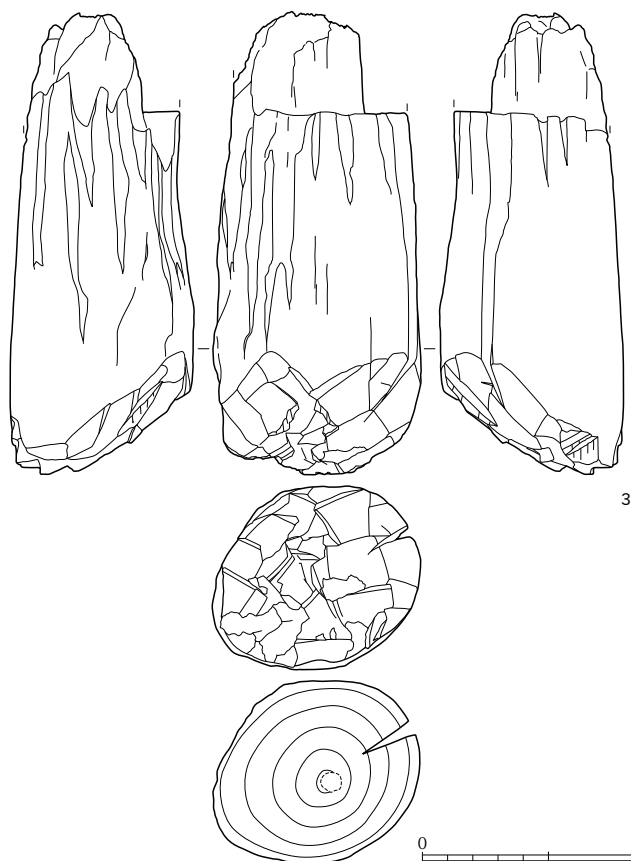

SA1547P3(4)

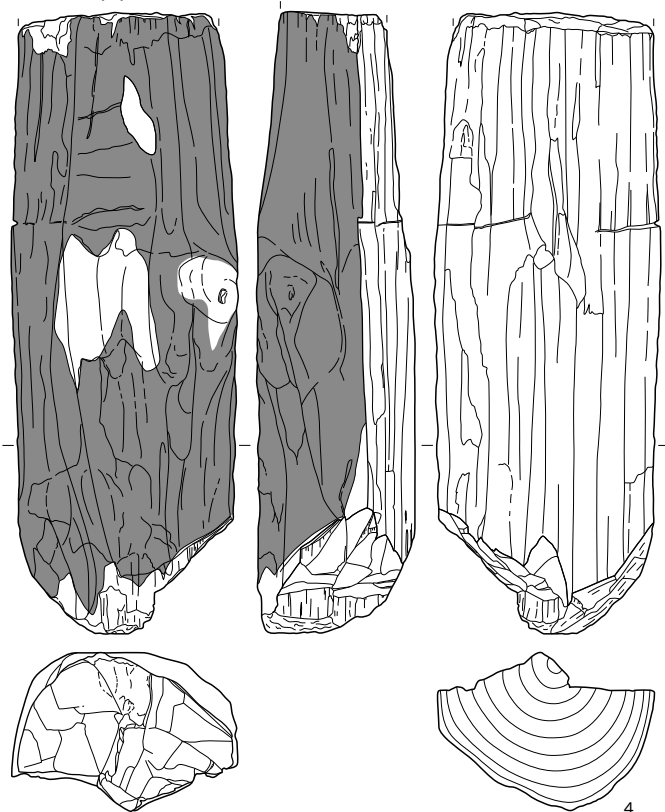

0 20cm (1:6)

SA1548P2(5)

SA1549P2(7)

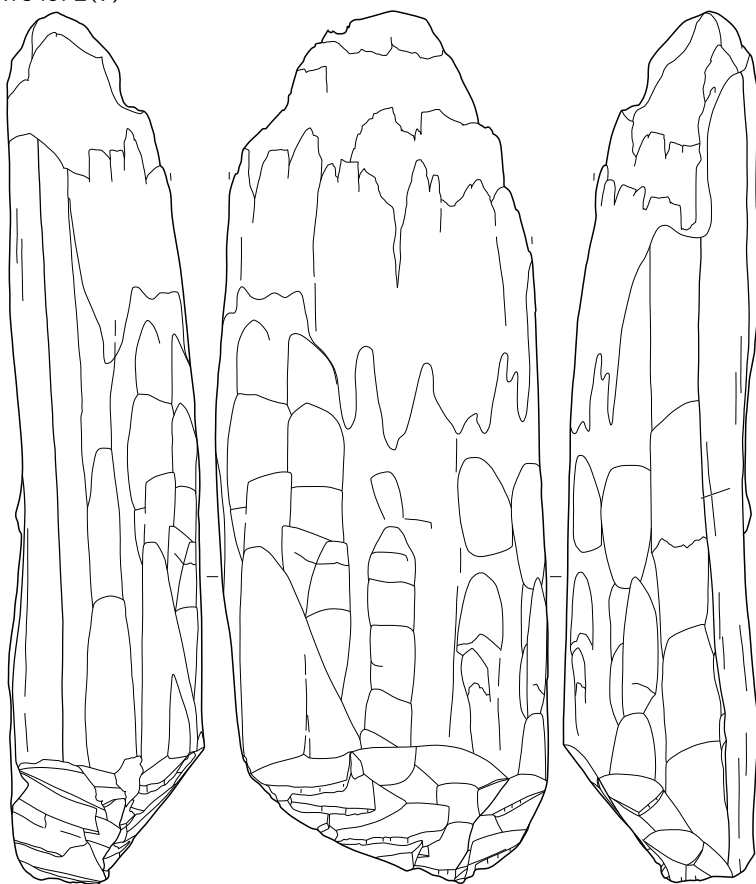

5

7

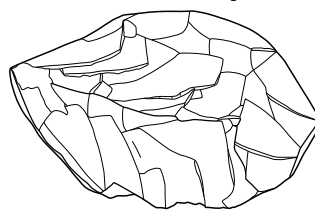

SA1549P1(6)

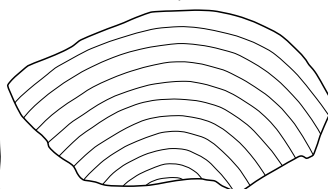
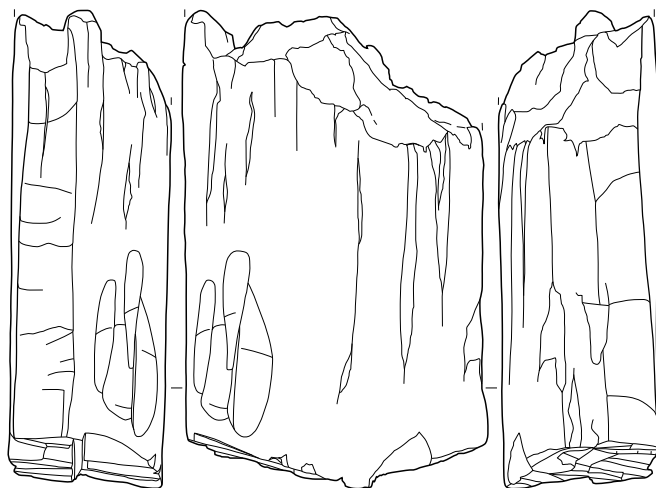

6

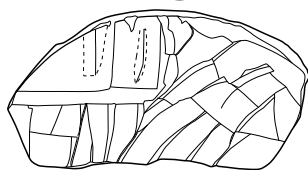

SB1561P1(8)

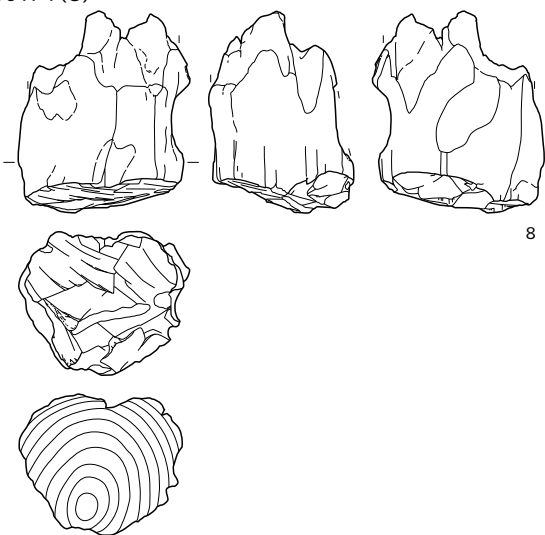

SB1561P9 (10)



SB1561P8(9)

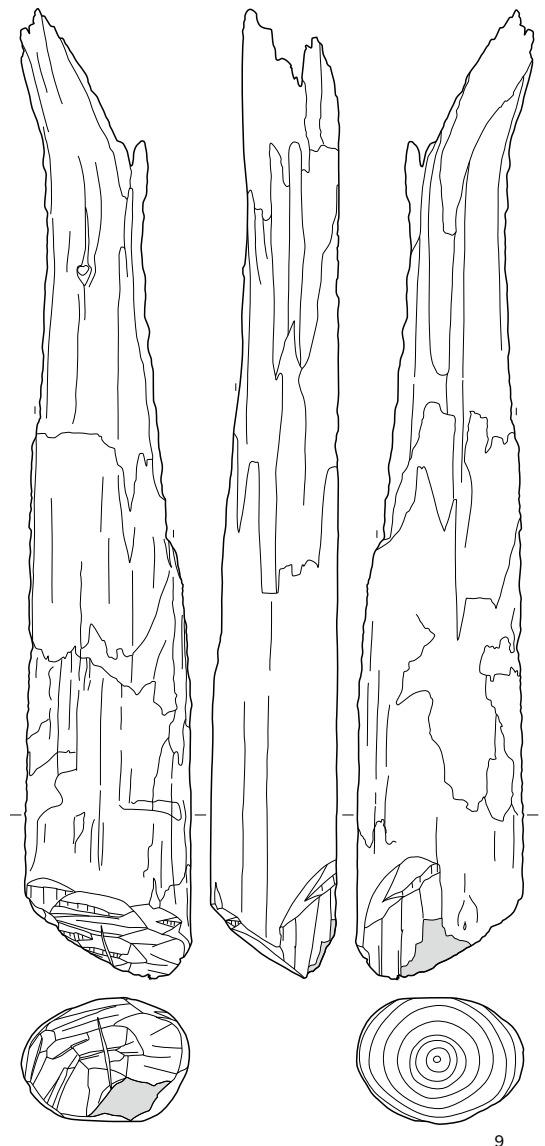

SB1562P3(11)

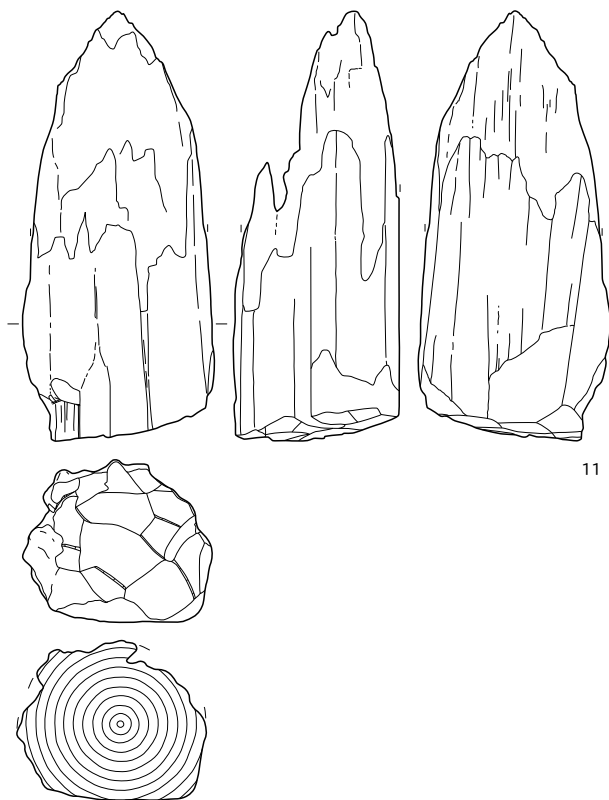

SB1563P2(12)

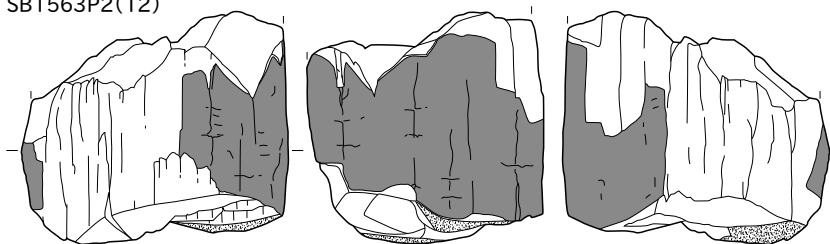

12

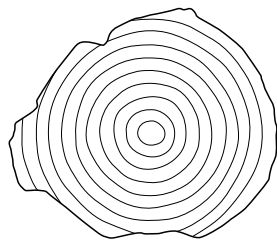
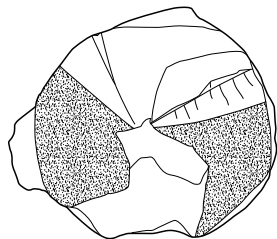

SB1563P3(13)

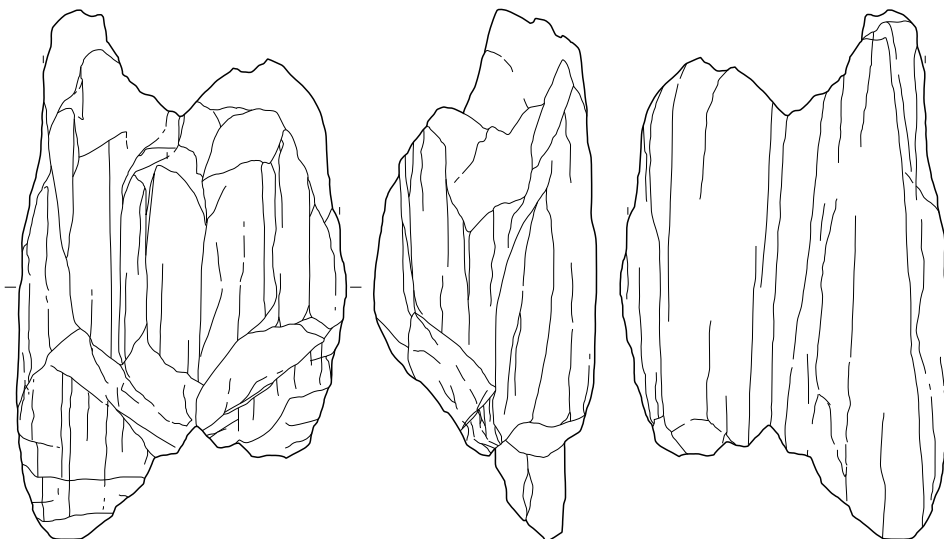

13

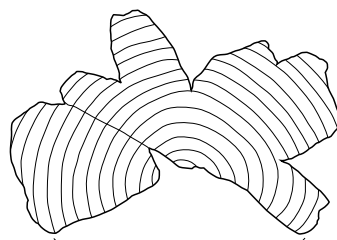

SB1563P4(14)

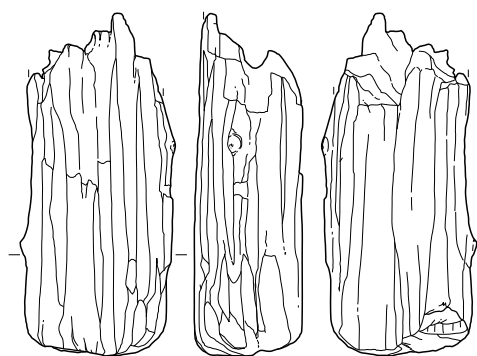

14

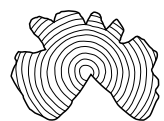

SB1563P5(15)

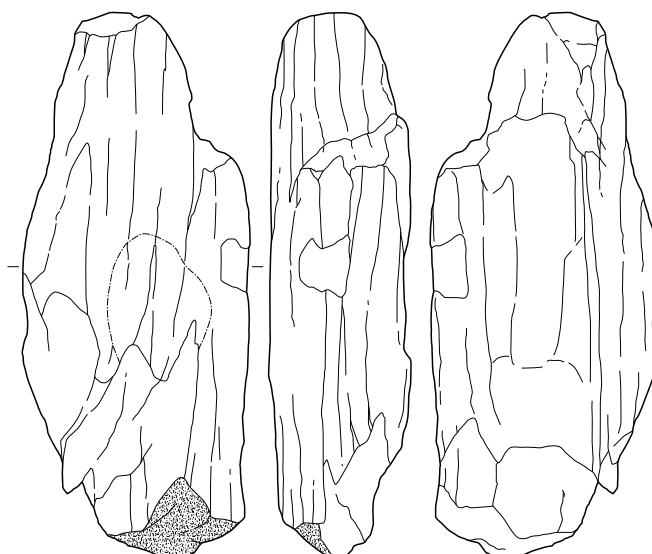

15

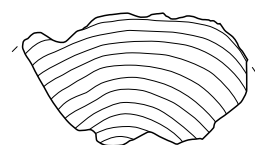

SB1563P6(16)

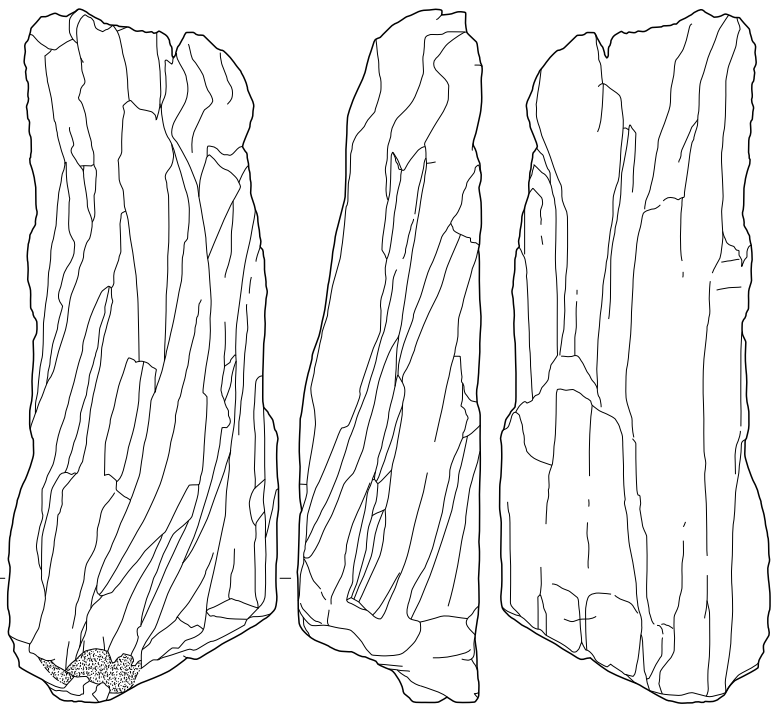

16

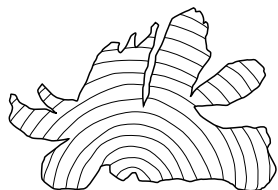
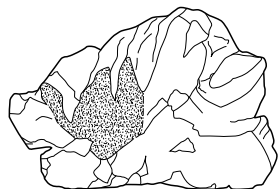

SB1563P7(17)

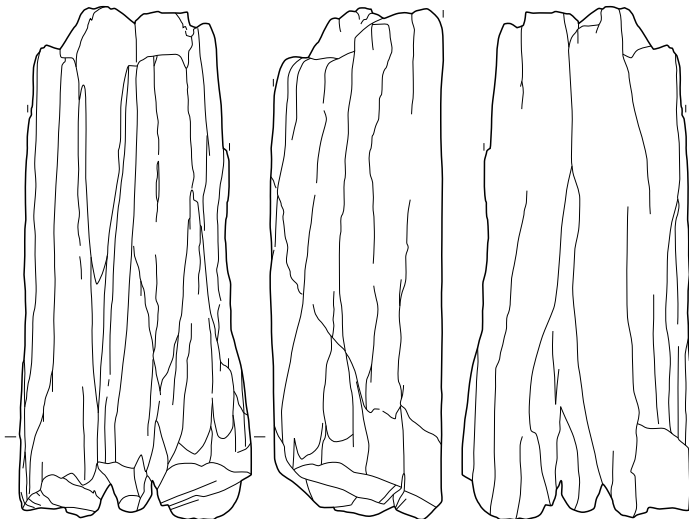

17

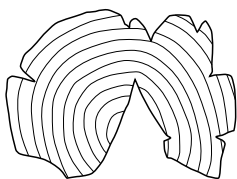
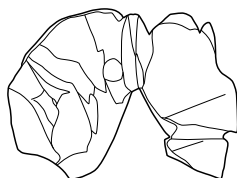

SB1563P8(18)

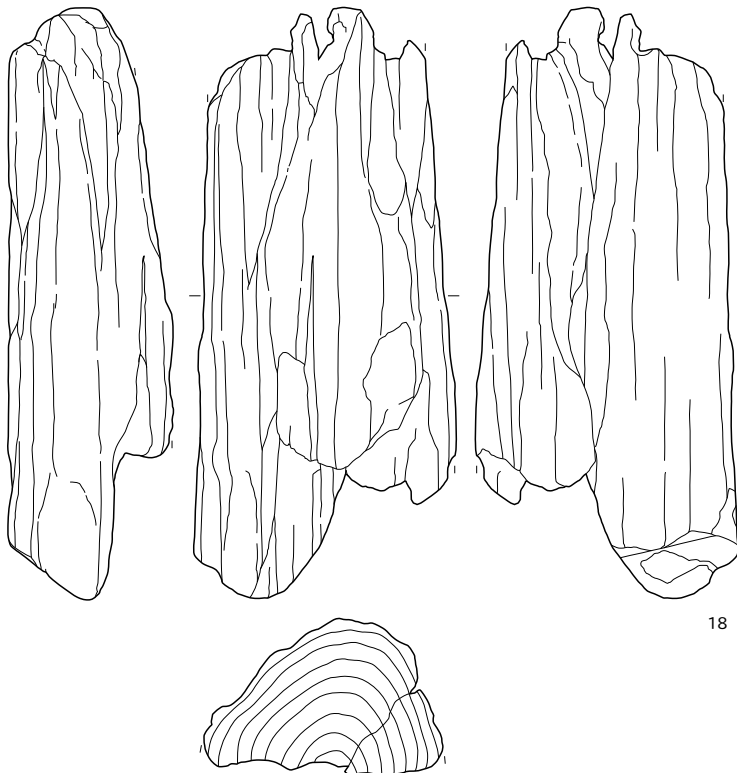

18

SB1563P9(19)



19

SB1564P6(20)

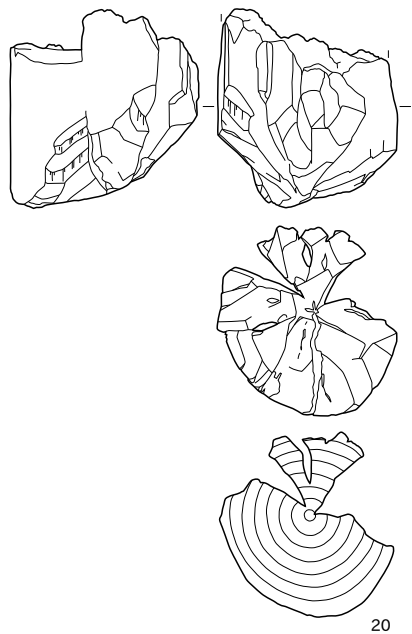

20

SB1564P14(21)

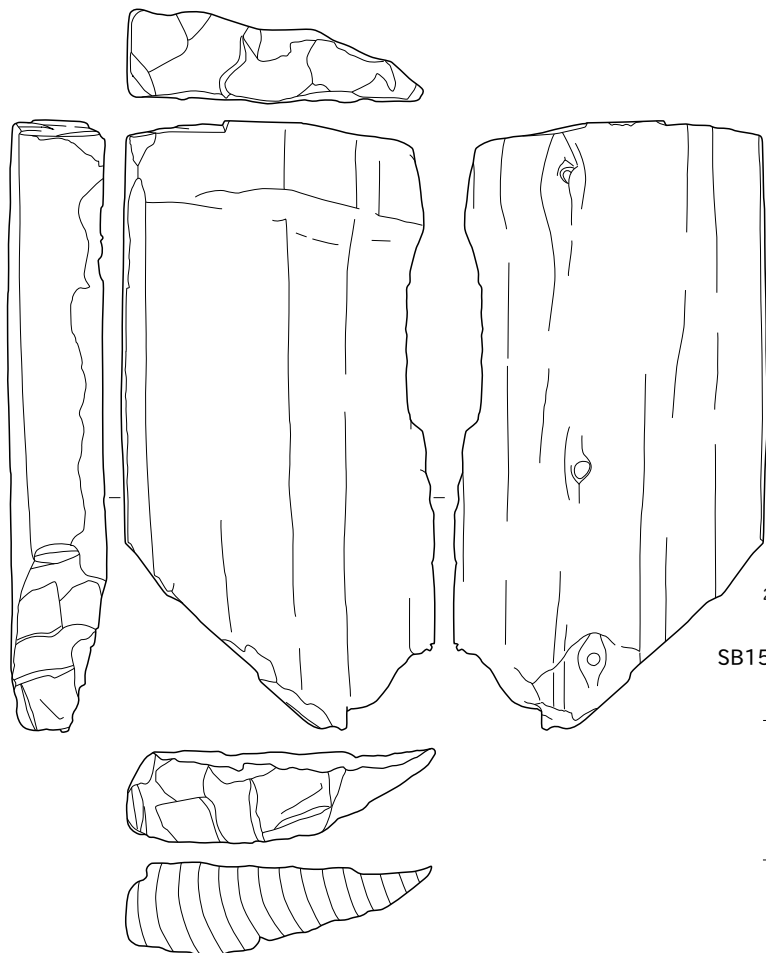

21

SB1566P8(22)

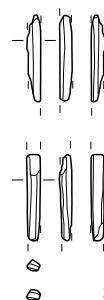

22

0 (19・20) 20cm (1:6)

0 10cm (1:3)

SB1569P1(23)

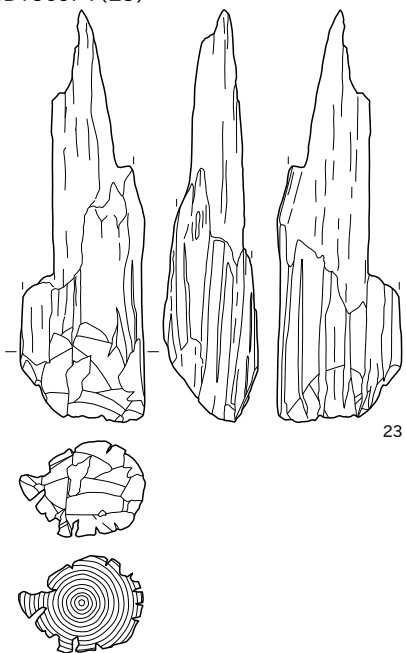

SB1570P1(27)

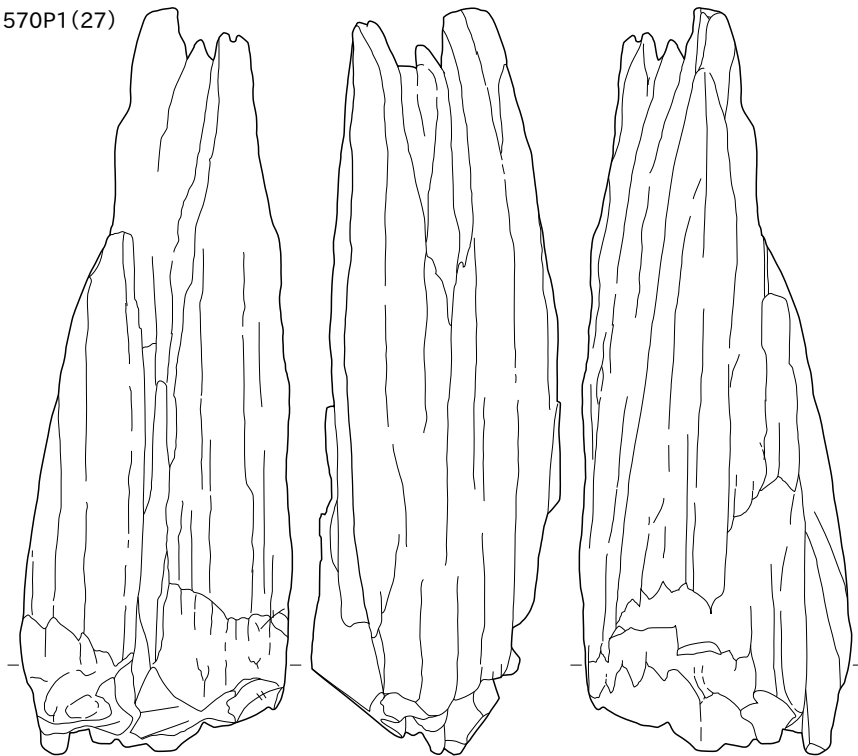

SB1569P3(24)

SB1569P7(25)

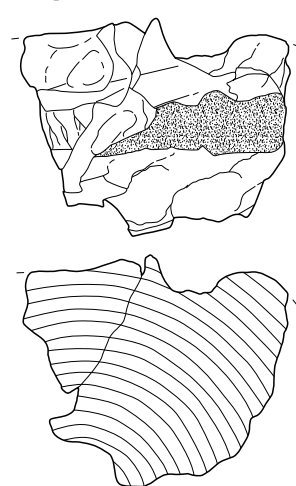
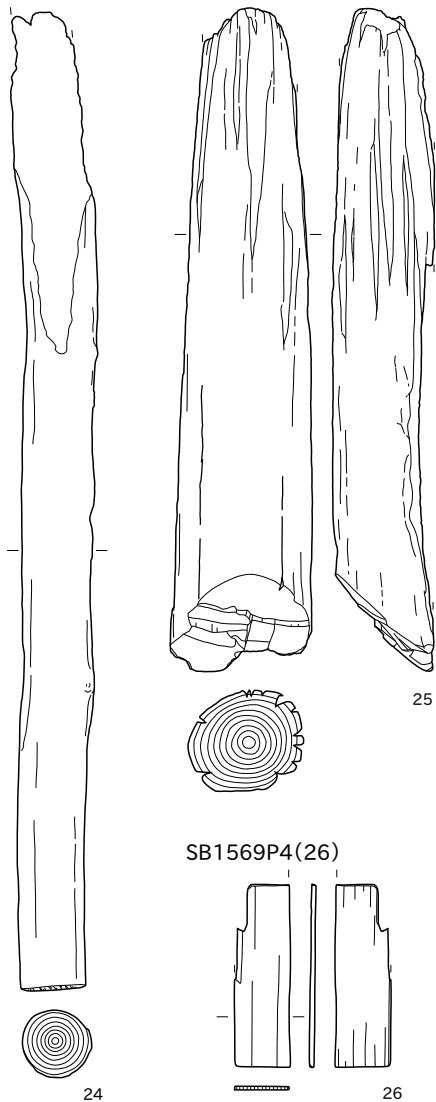

SB1570P2(28)

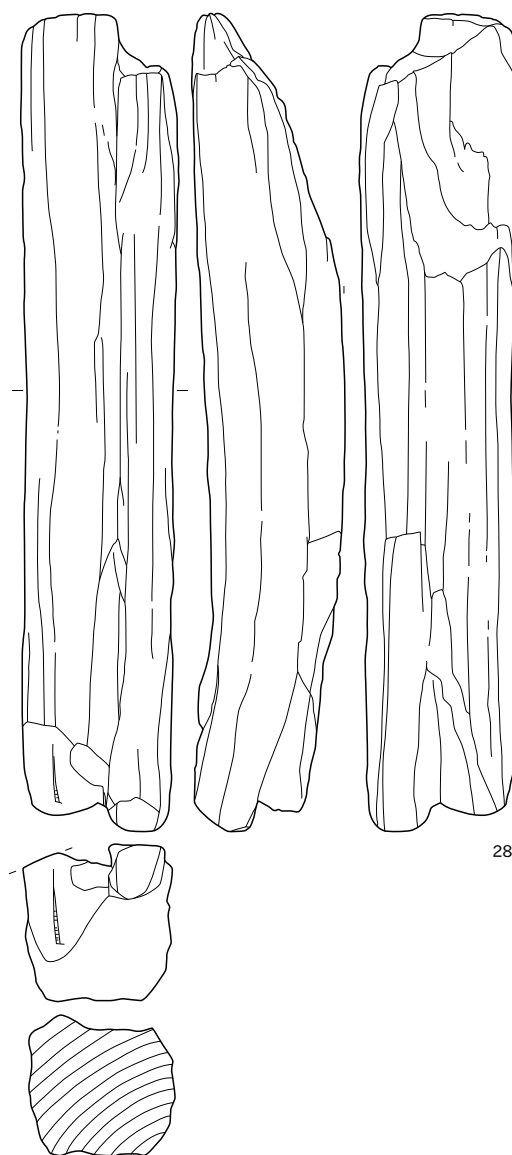

SB1569P4(26)

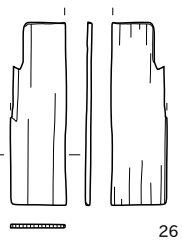

0 (23~25) 20cm (1:6)

0 10cm (1:3)

SB1570P3(29)

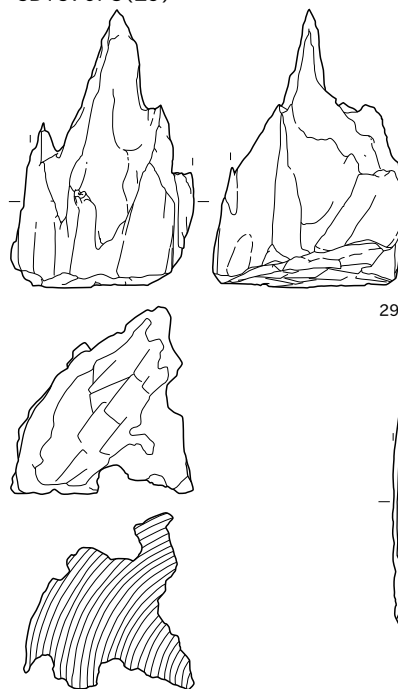

29

SB1570P4(30)



30

SB1571P3(32)

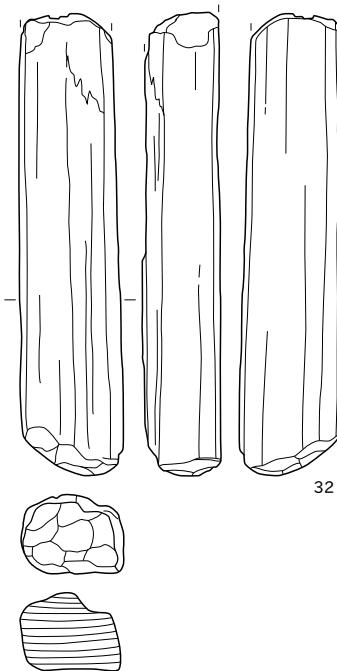

32

SB1570P6(31)

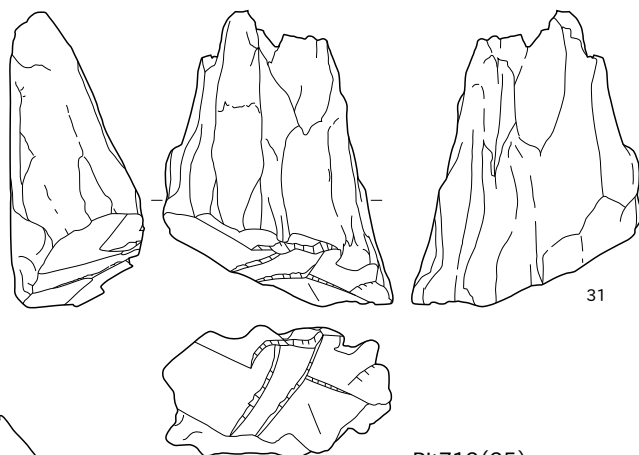

31

SB1575P3(33)

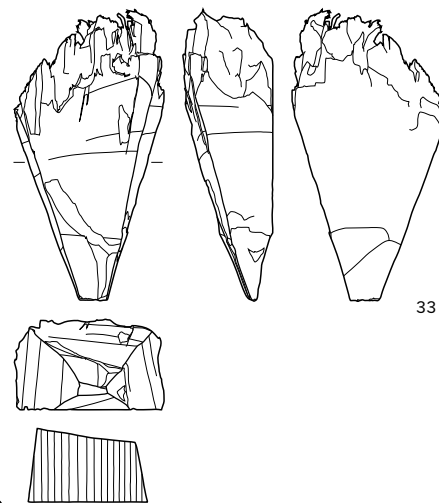

33

Pit589(34)

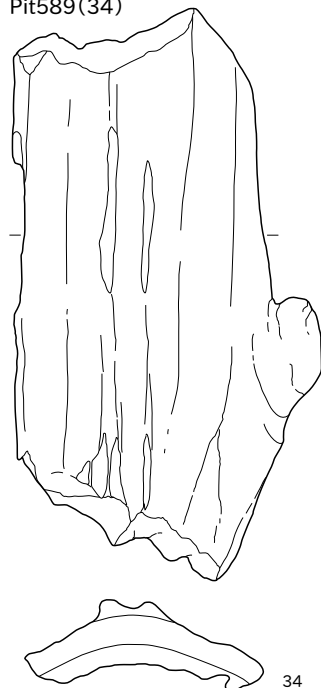

34

Pit713(35)

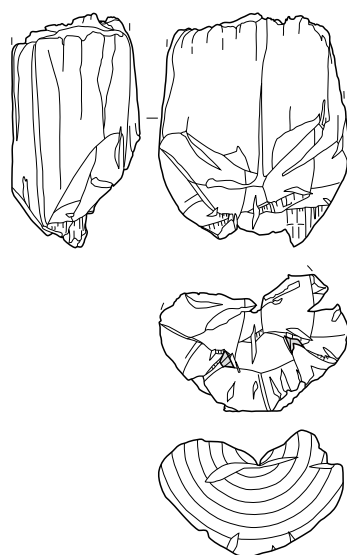

35

Pit922(36)

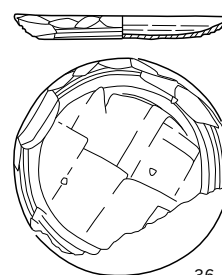

36

Pit581(37)

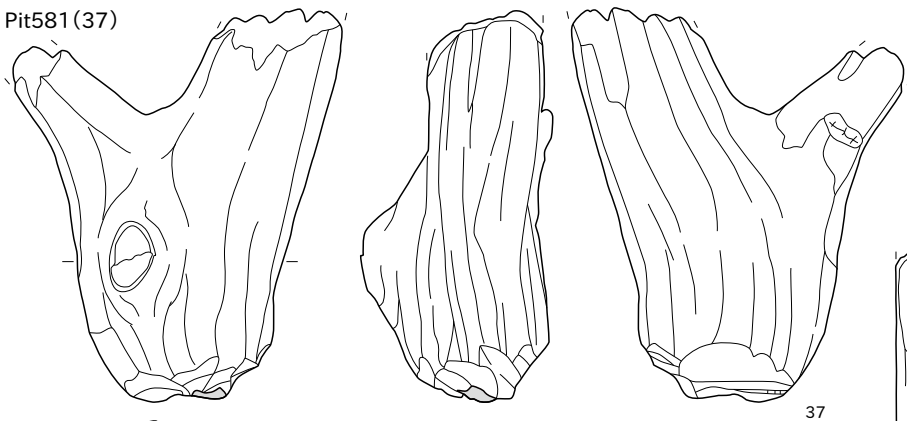

Pit592(39)

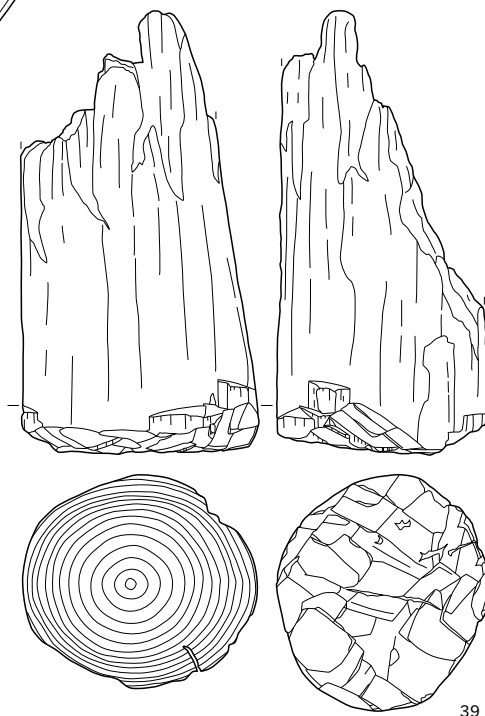

Pit590(38)

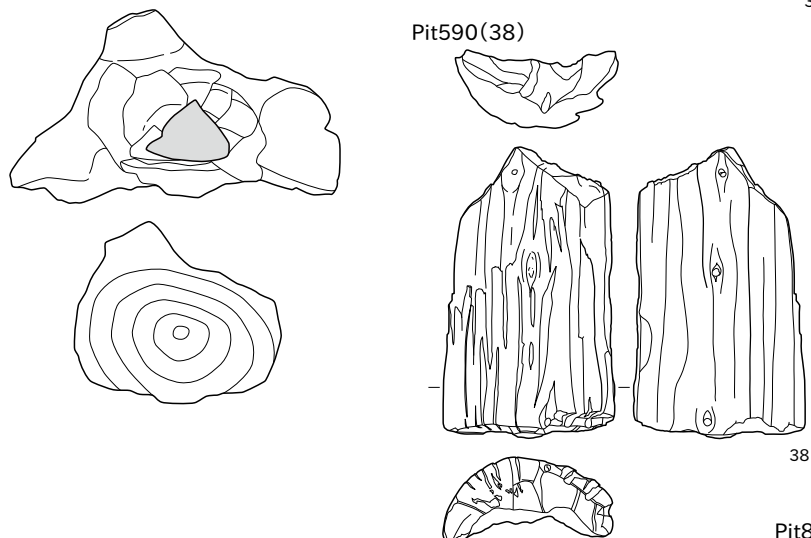

Pit783(40)



Pit880(41)

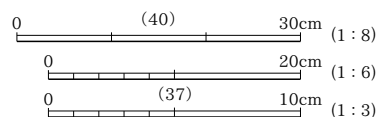
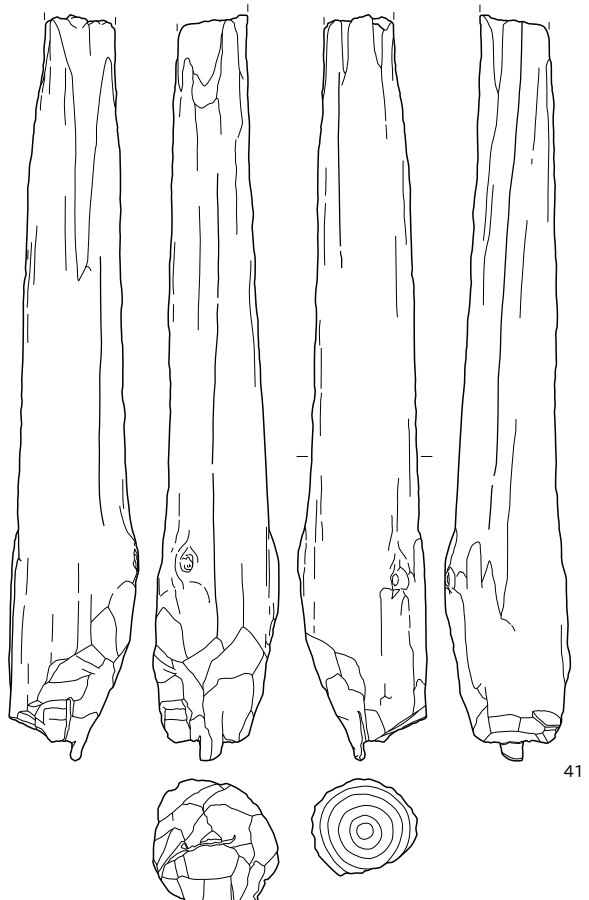

Pit1062(42) Pit1057(43)



42

Pit533(47)



43

Pit531(48)



48

Pit530(49)



Pit1024(44)

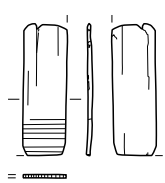

44

Pit1488(45)



45

Pit532(46)



46

SD153(50·51)

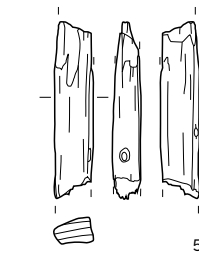

50

47

SD158(52)

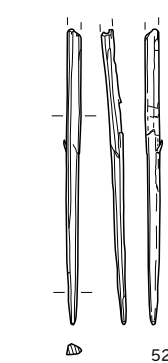

52

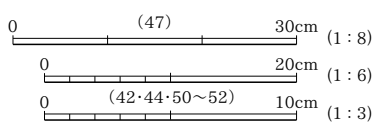

SE173(53・54)

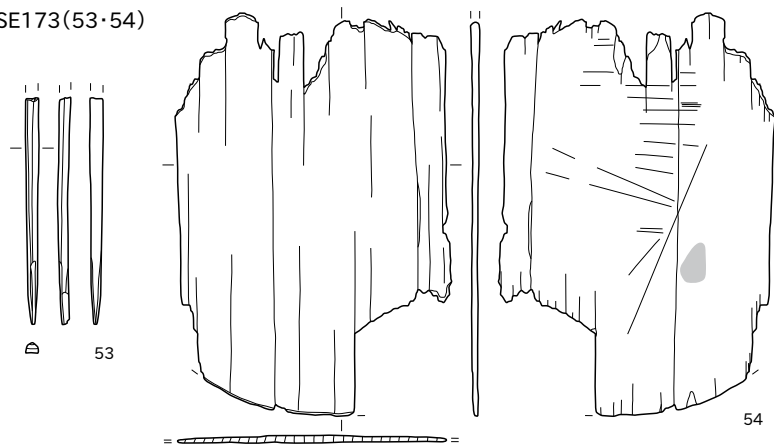

SE80(59~63)

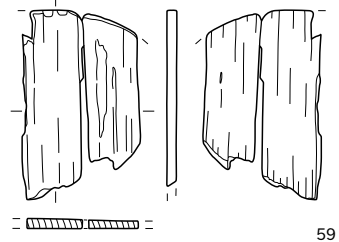

SE56(55)

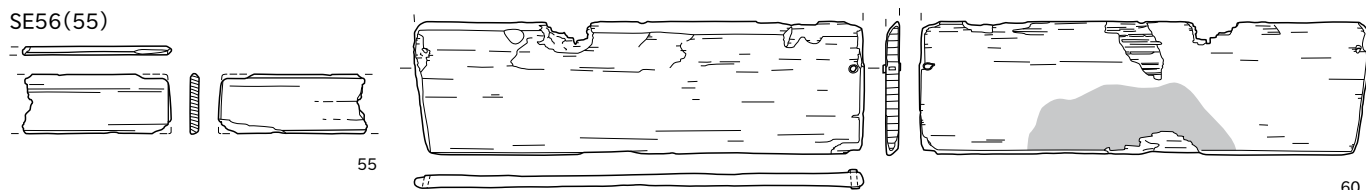

SE1518(56~58)

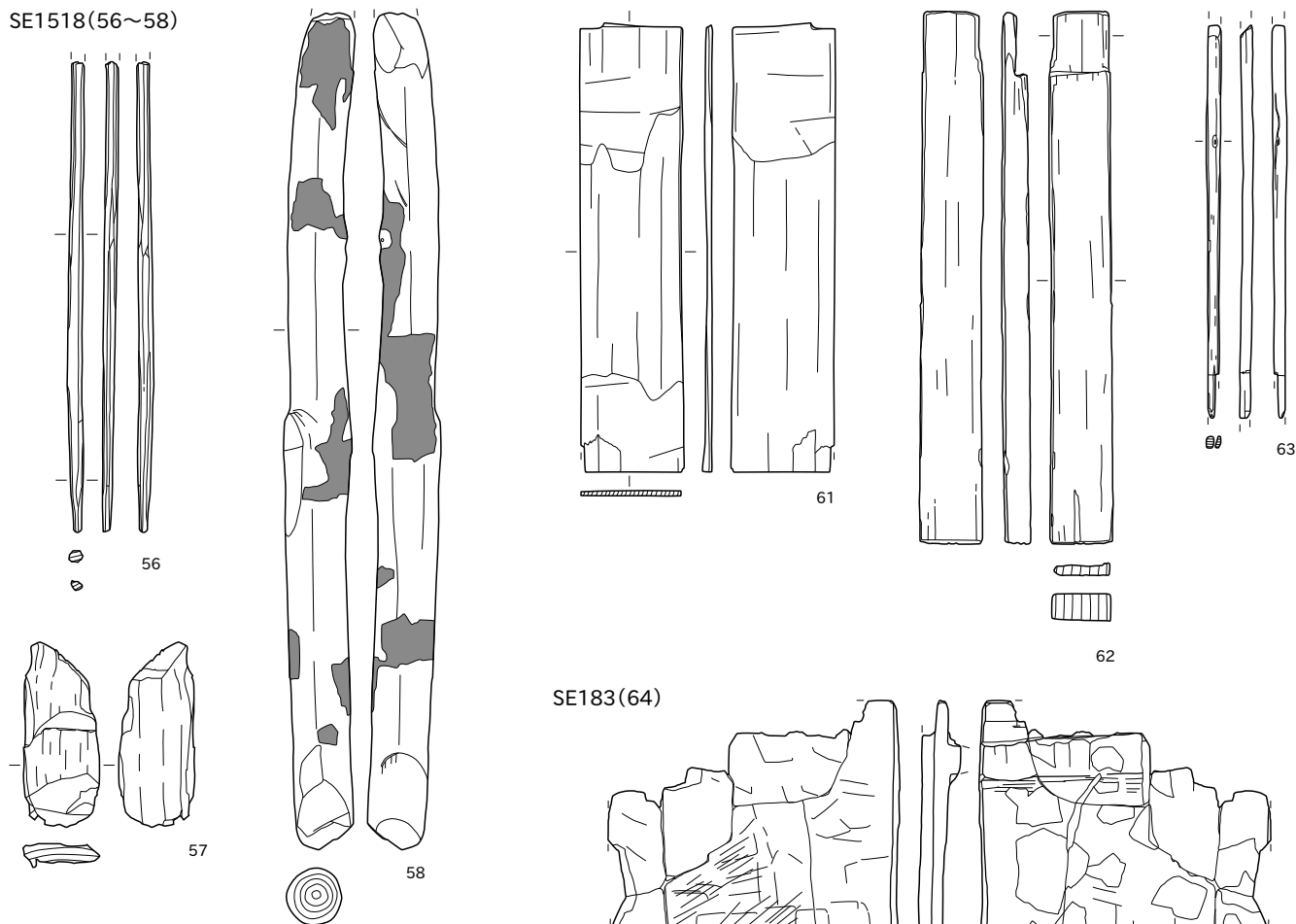

SE183(64)

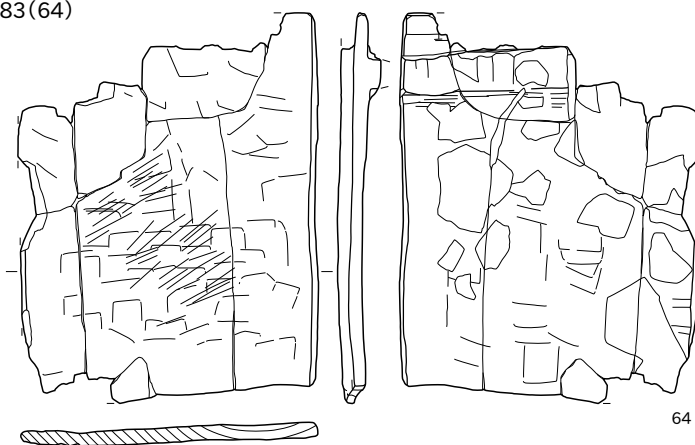

SE183(65・66)



65

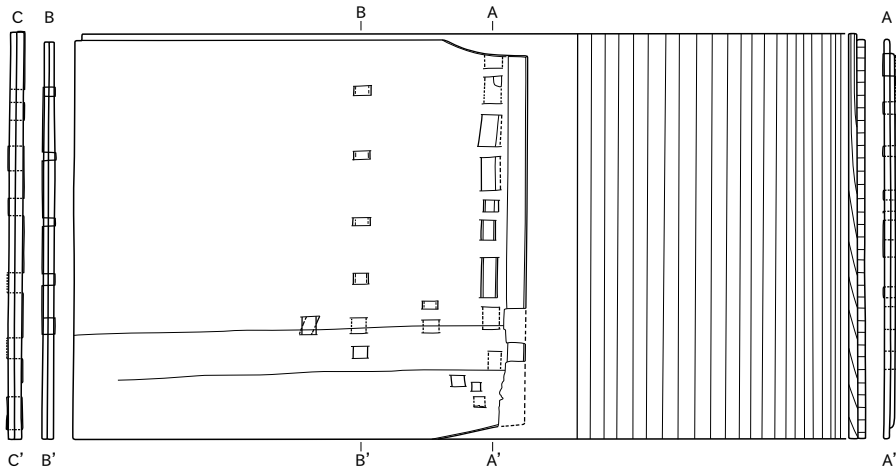
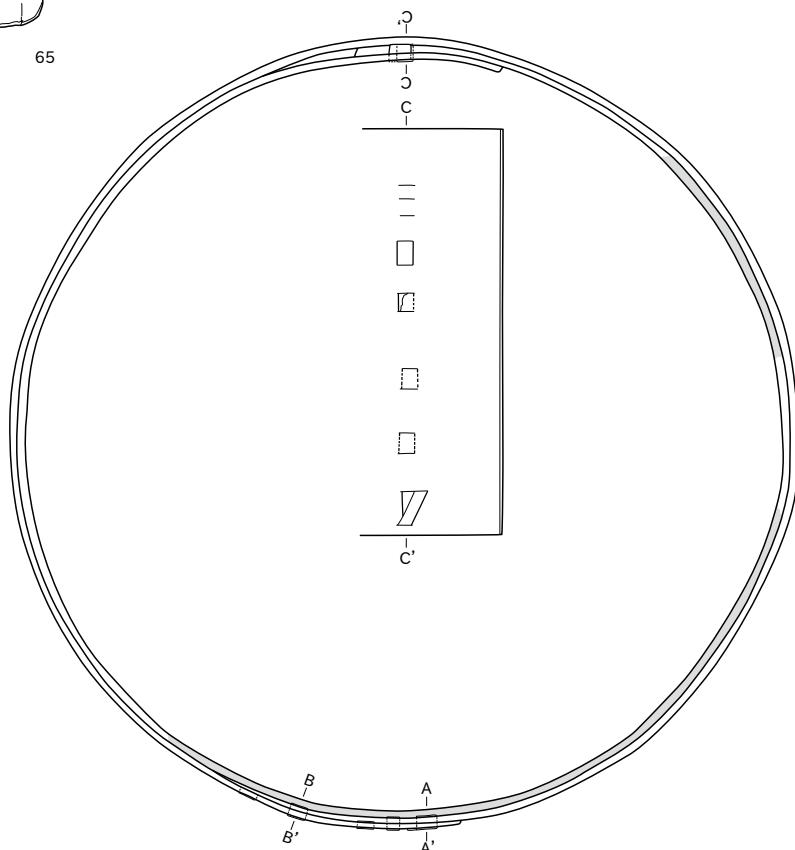

66

0 20cm (1:6)

SE183(67~71)

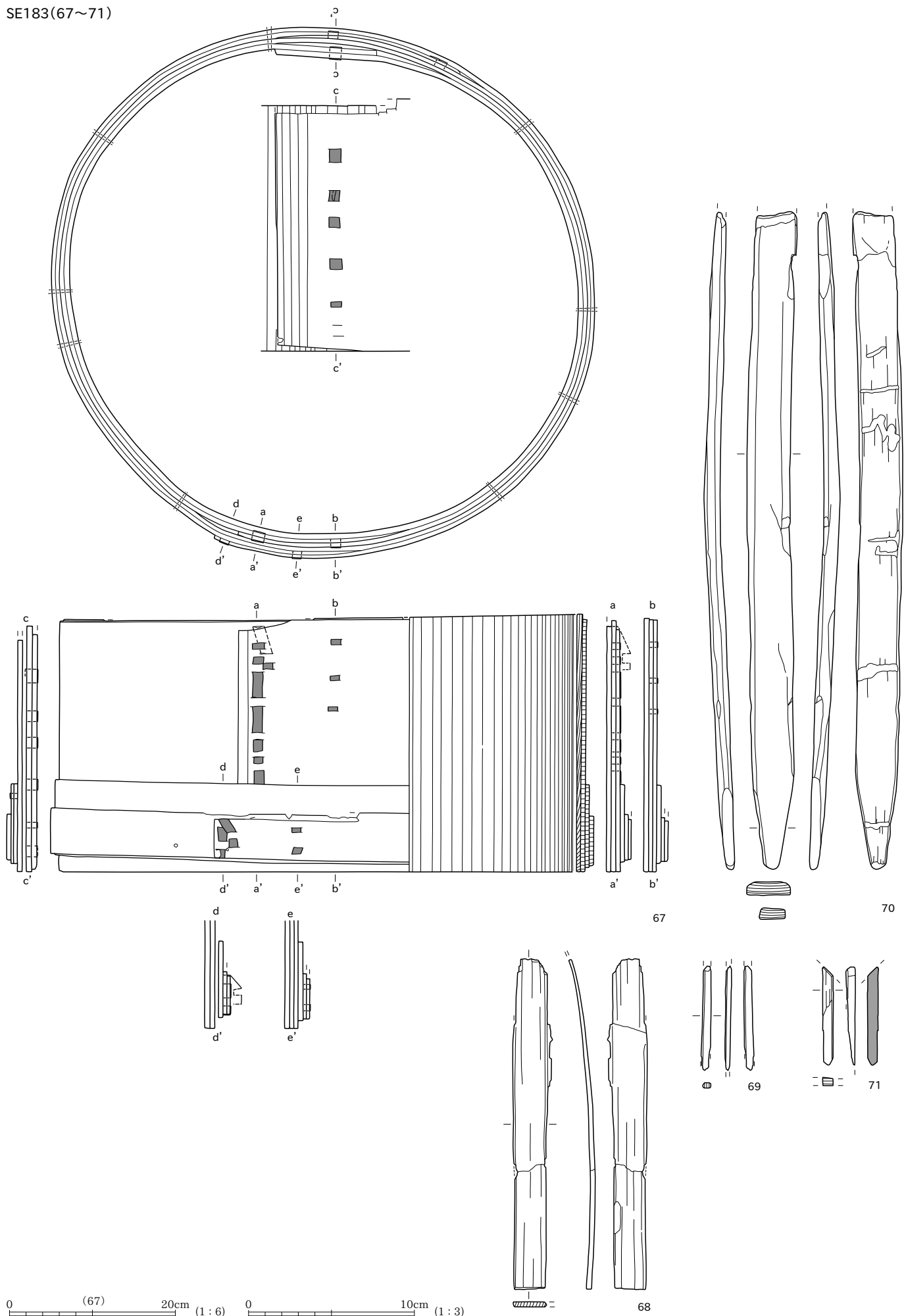

SE57(72~75)

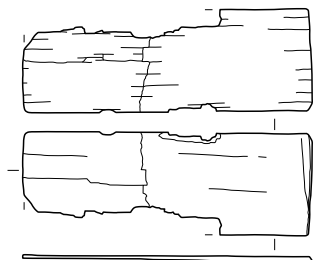
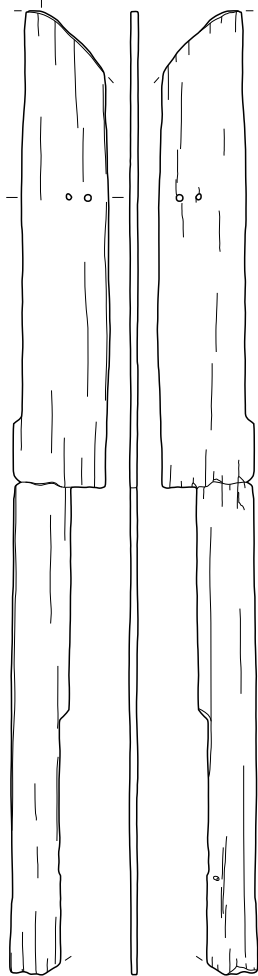

73

74

75

SE497(76-77)

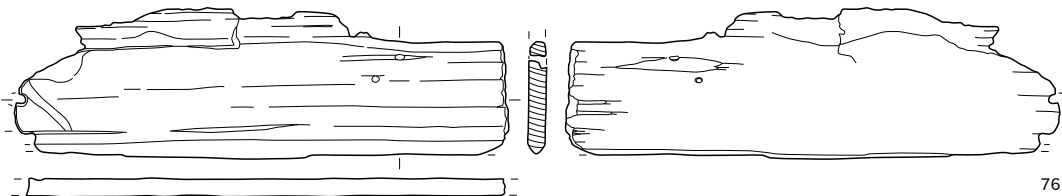

76

SE542(78-79)

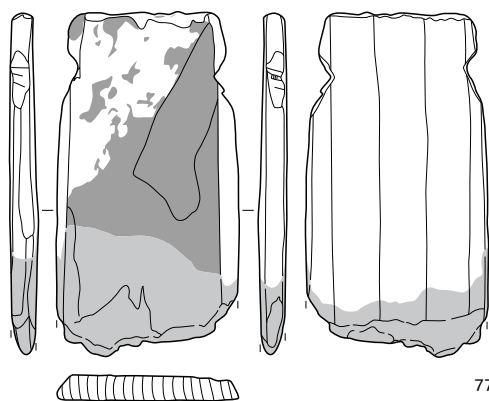

77

78



72

SE588(80)

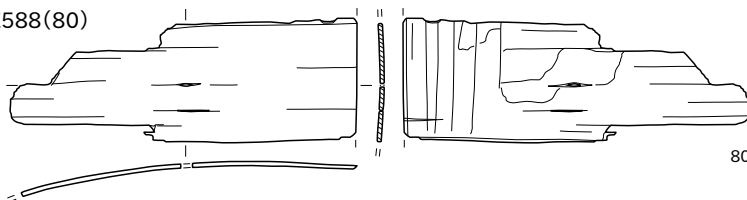

80

SE485(81~84)

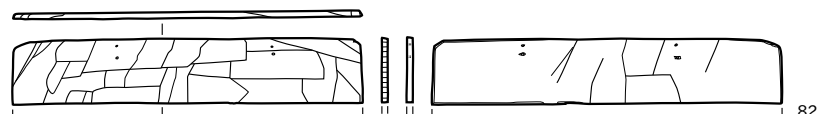

82

SE105(85~88)

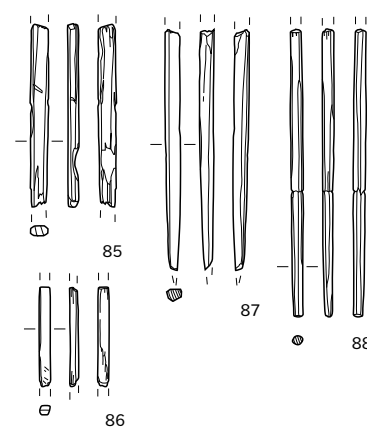

85

87

88

86

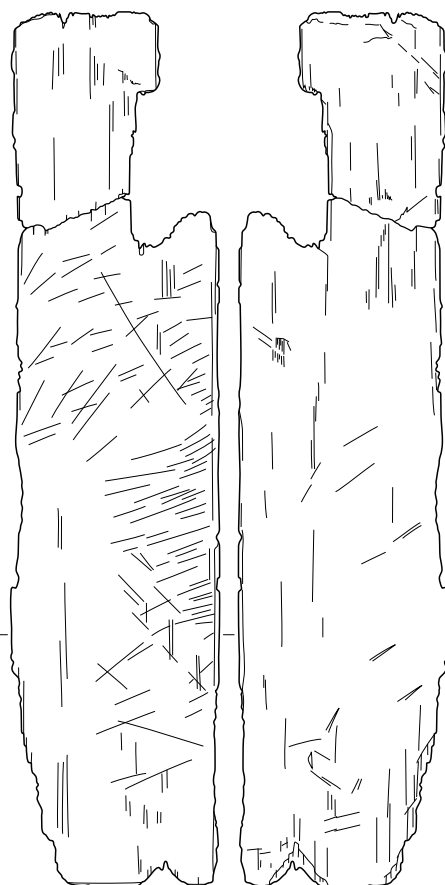

79



81

83

84

0 (77) 5cm (2:3)

0 (81-82) 20cm (1:6)

0 10cm (1:3)

SE105(89~98)

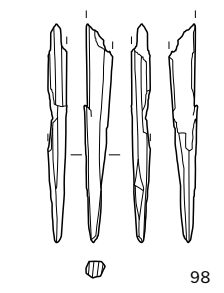
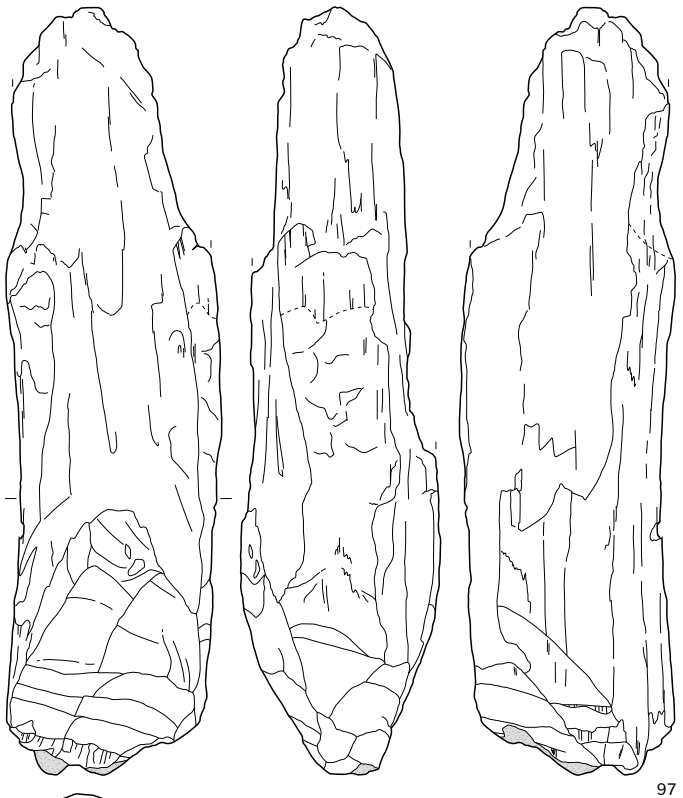
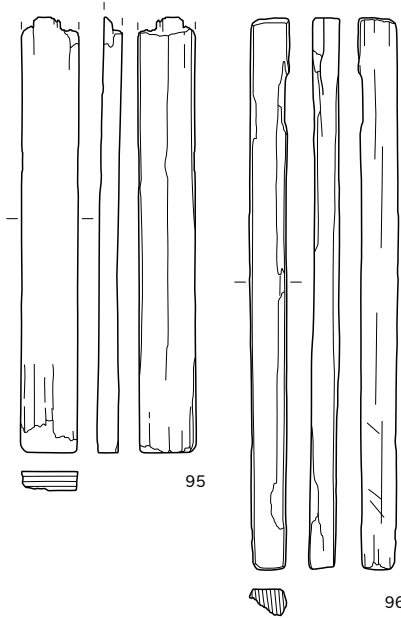
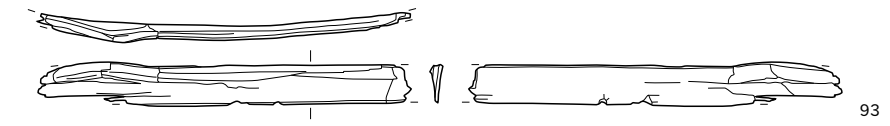
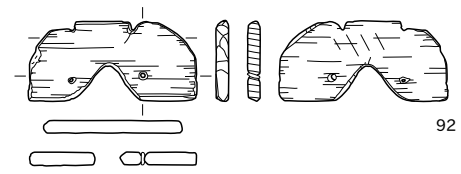
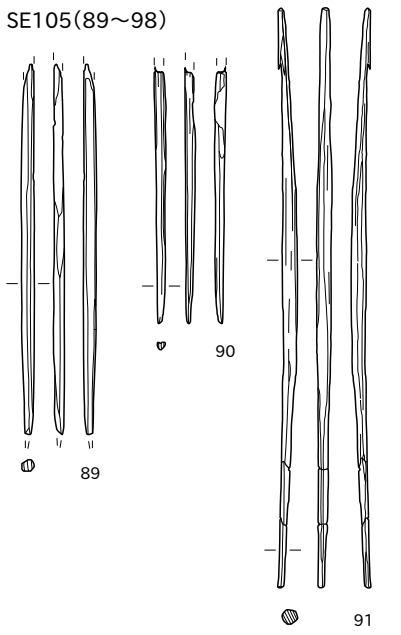

SE522(99~101)

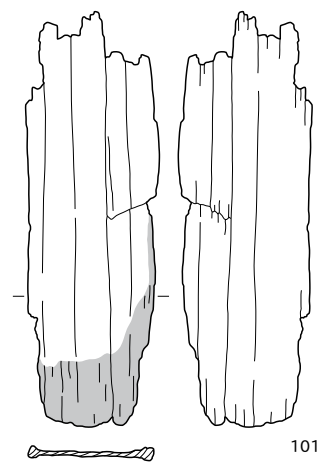
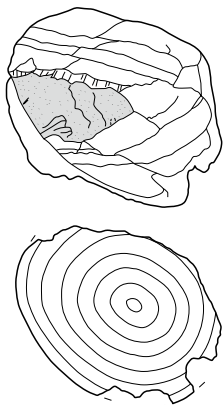
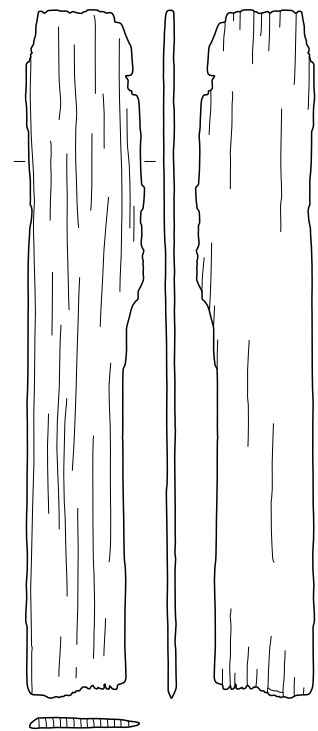
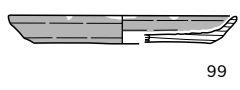

SE556(102・103)

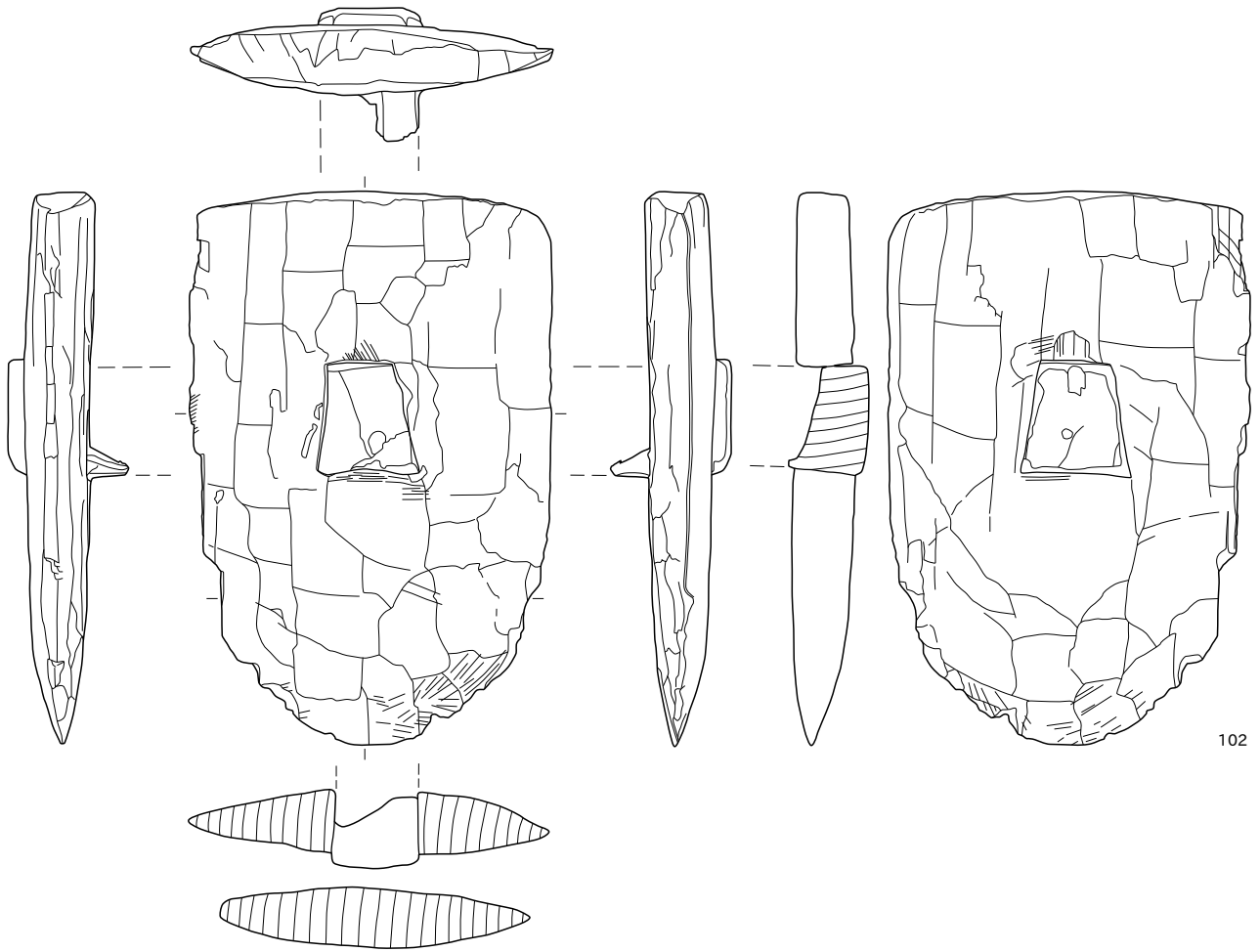

102



103

SE556(104~123)

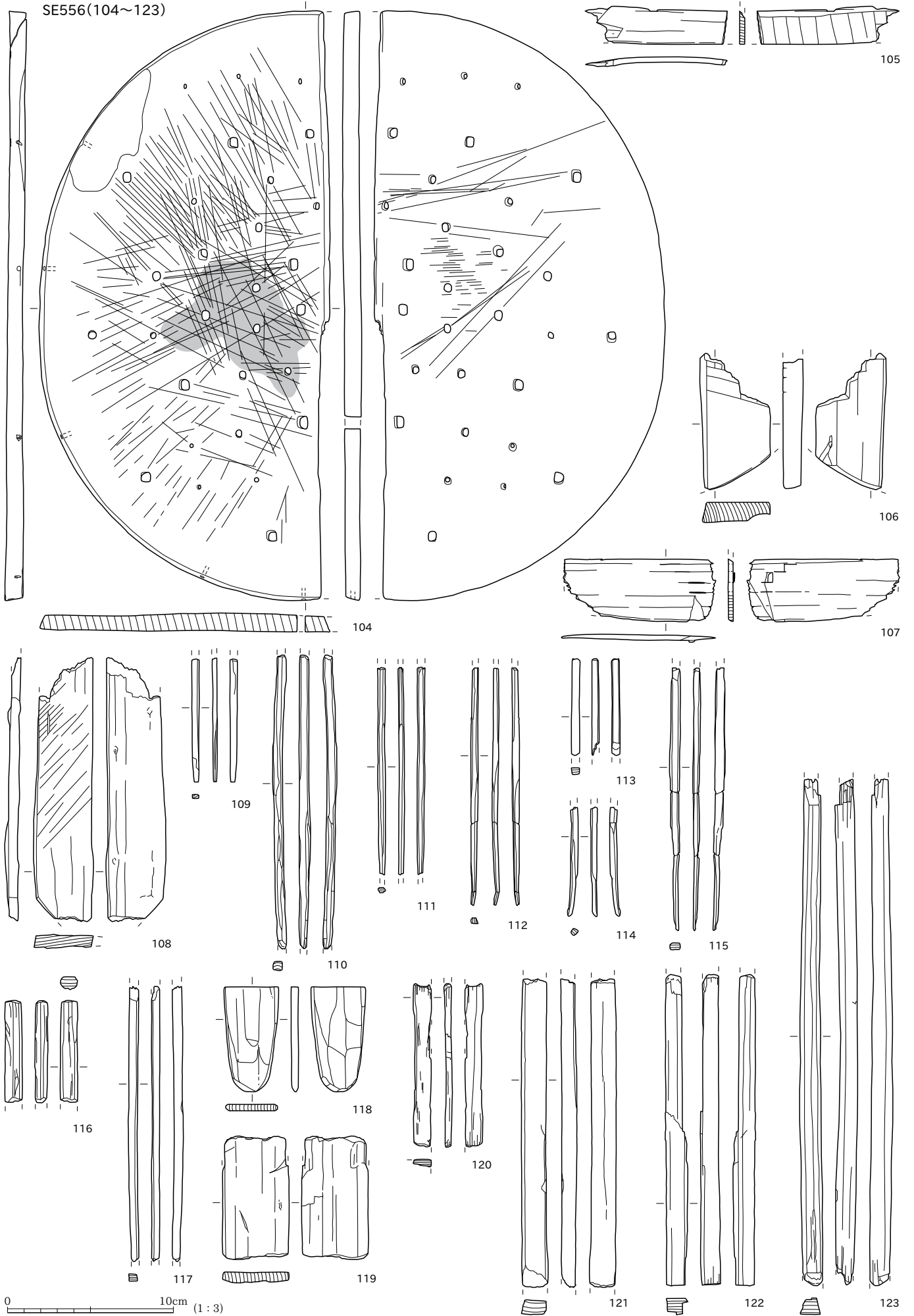

SE556(124~133)

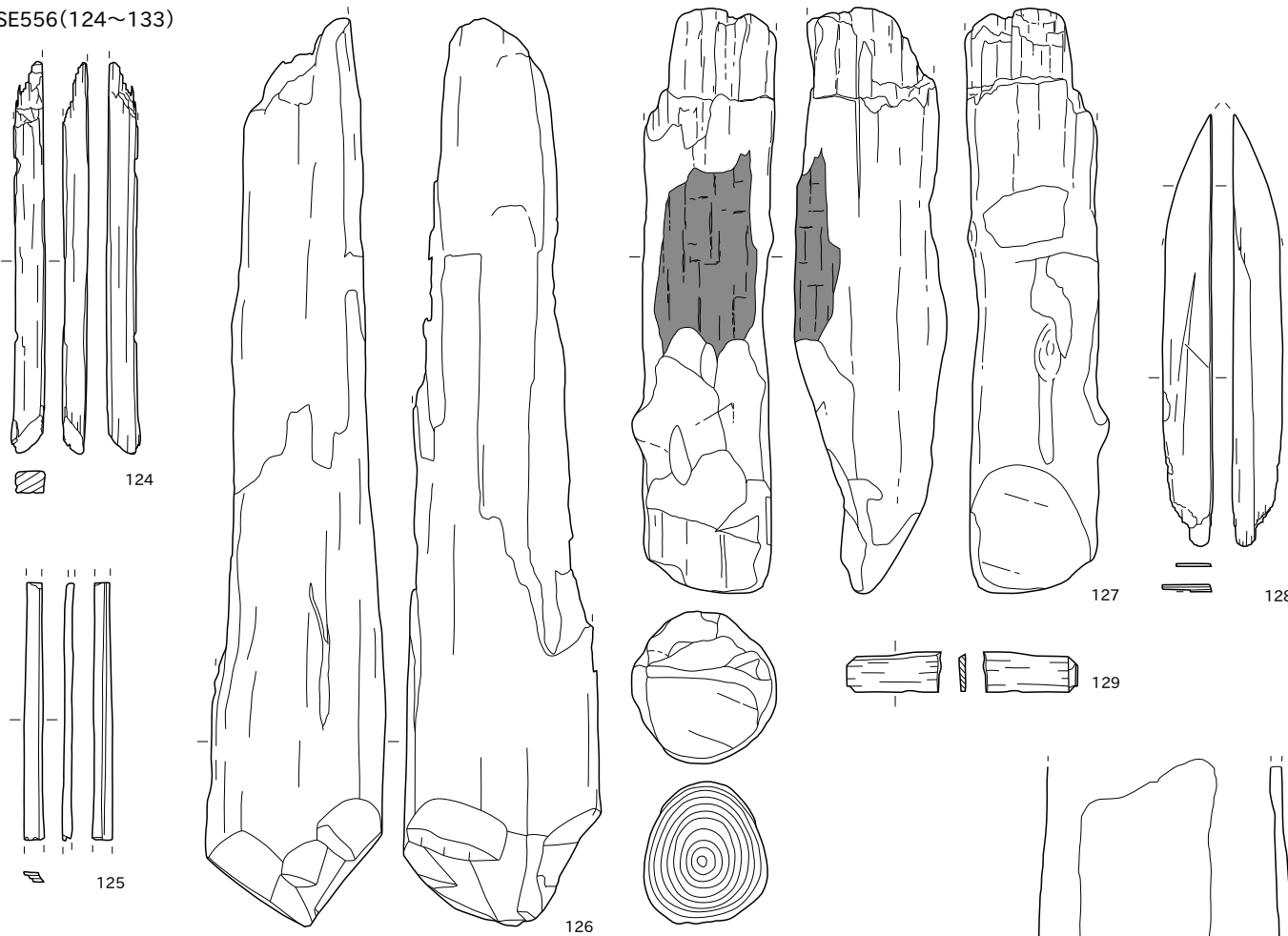

SE577(134~137)

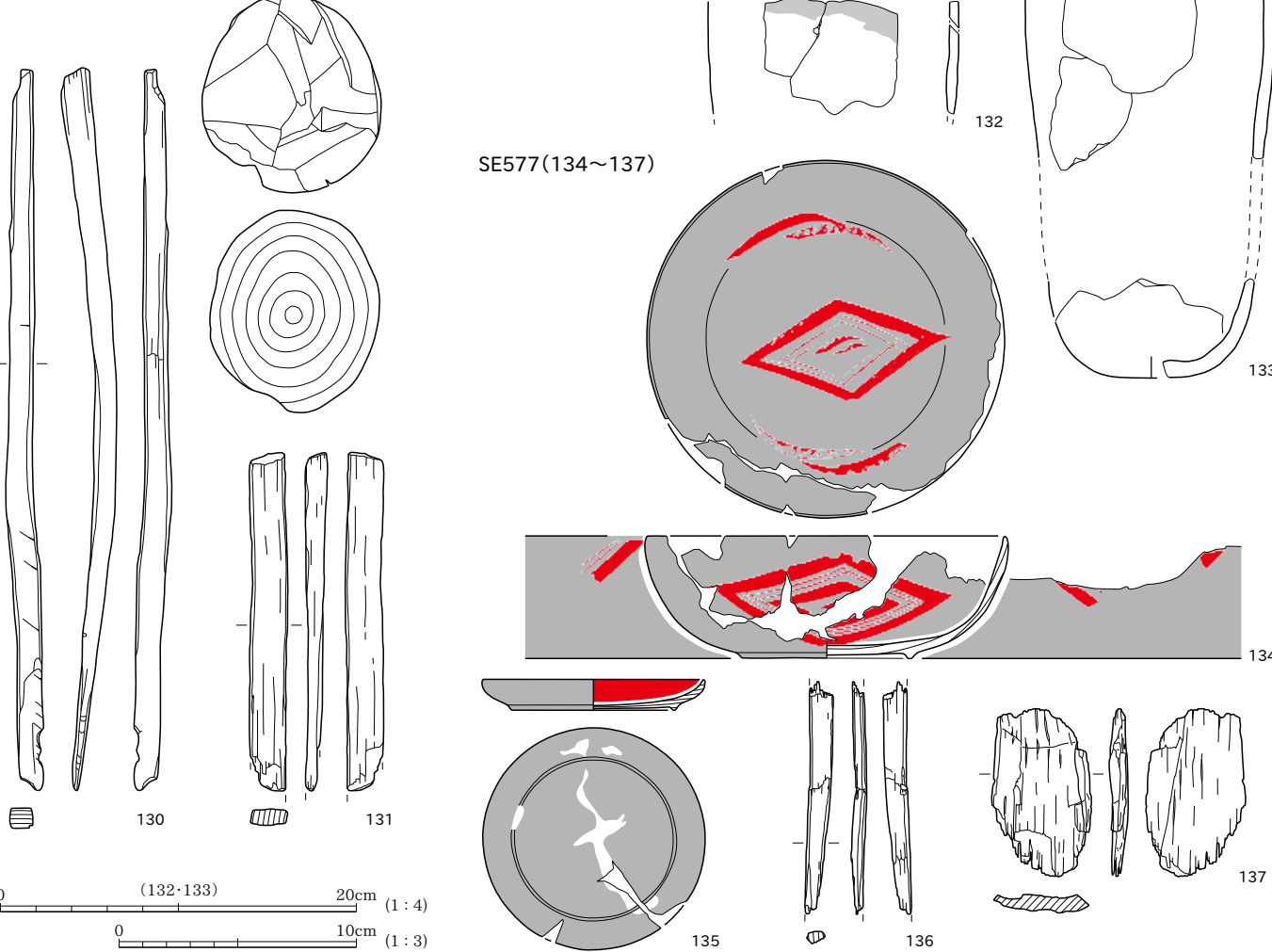

0 (132-133) 20cm (1:4)
 0 10cm (1:3)

SE917(138・139)

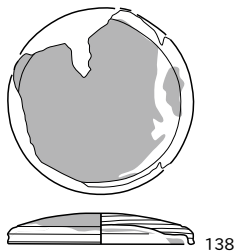

SE709(142)

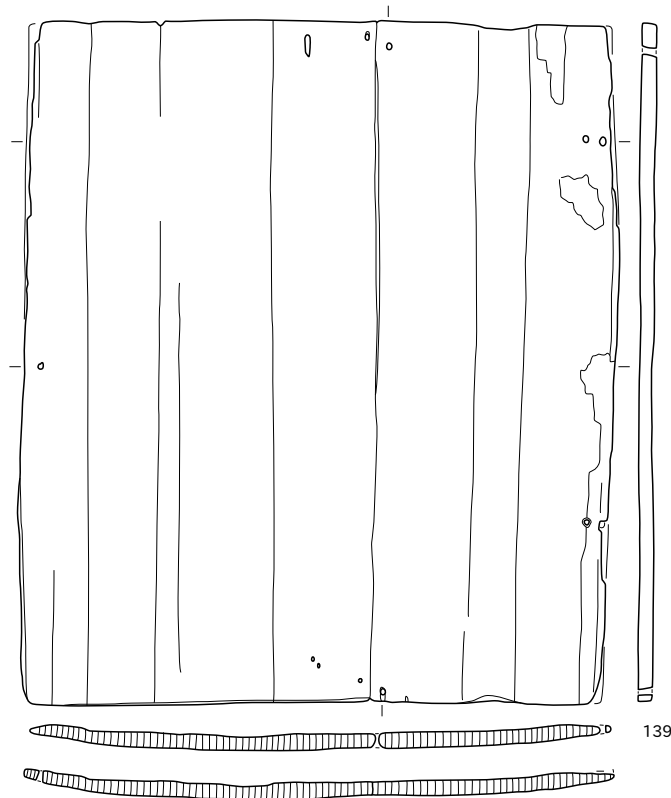
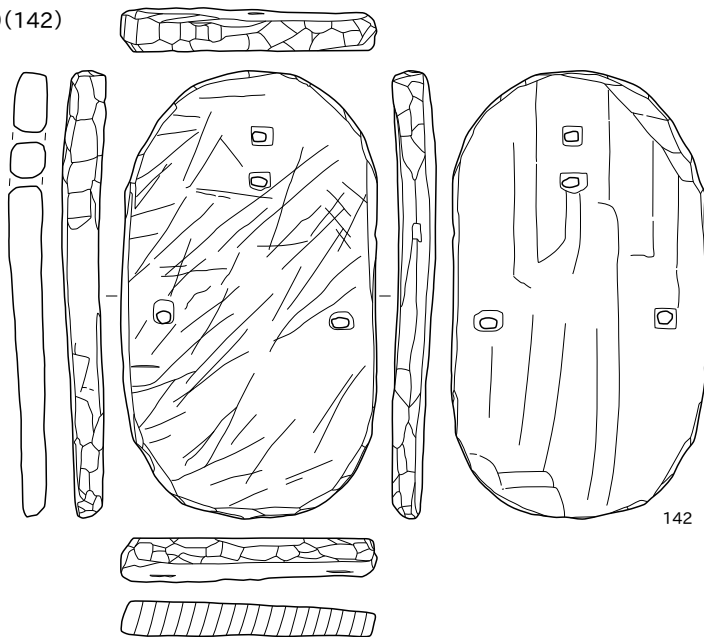

SE912(143)

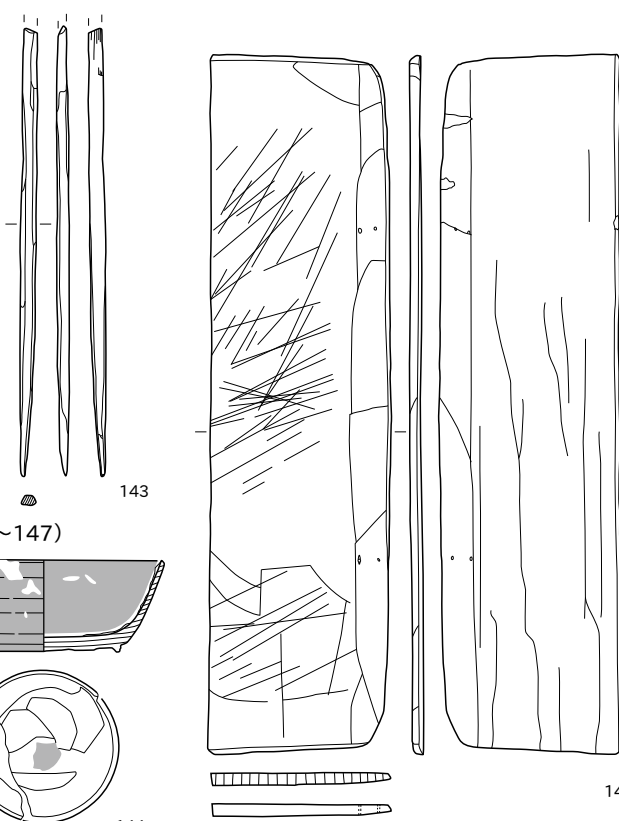

SE541(140・141)

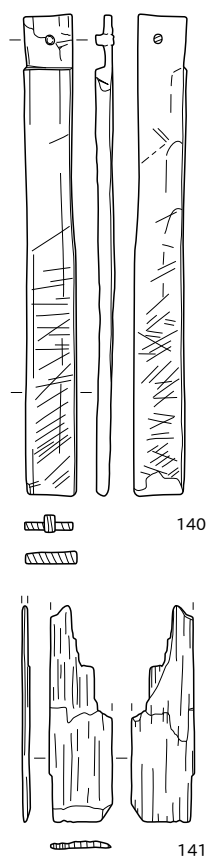

SE882(144~147)

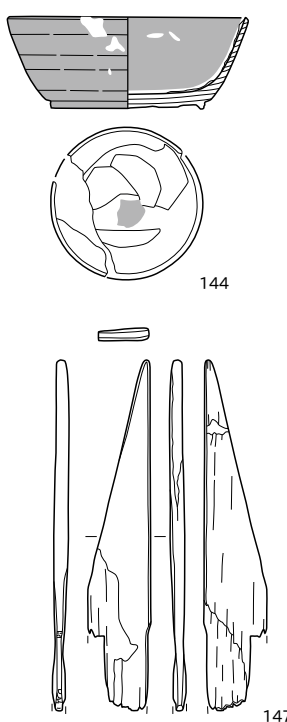

SE1070(148~150)

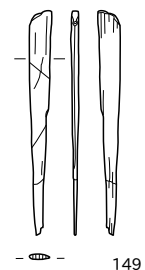
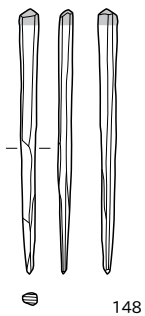

SE987(151)

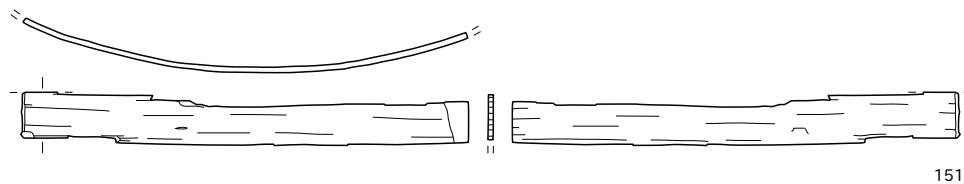

SE1363(152~154)

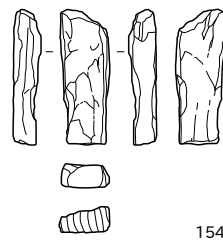
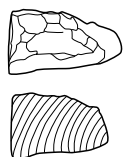
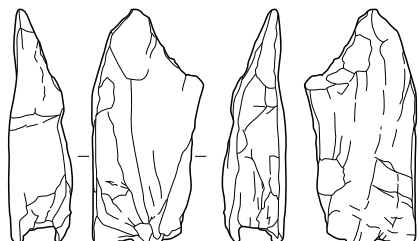
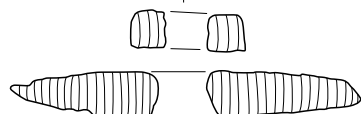

SE1363(155~159)

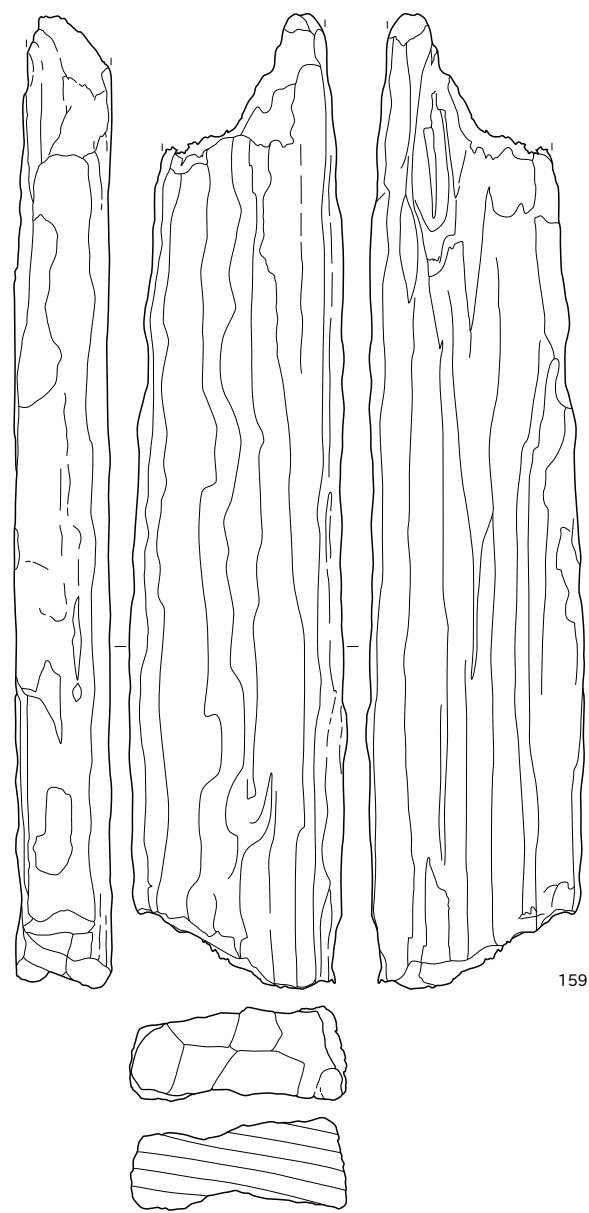
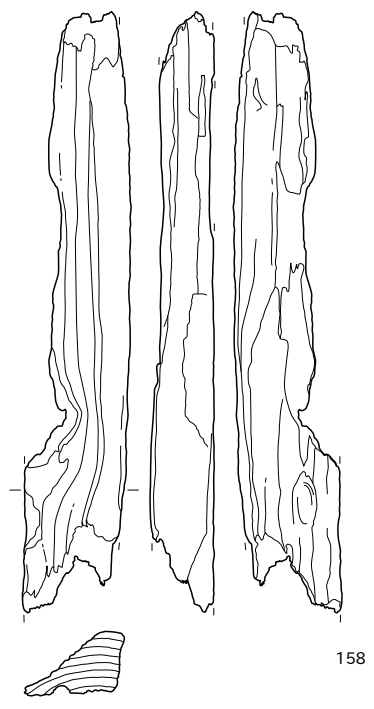
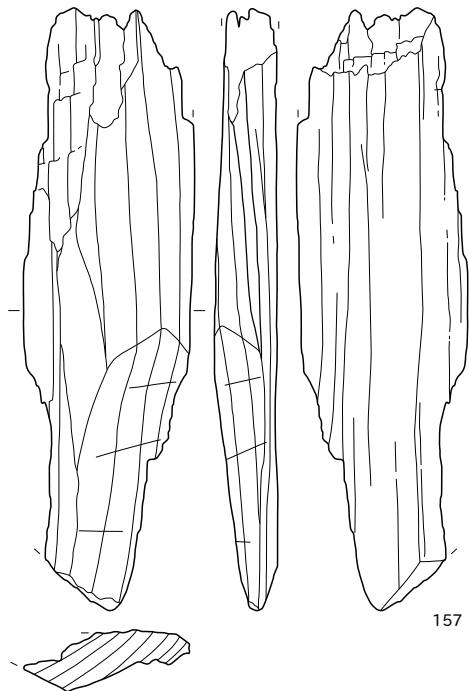
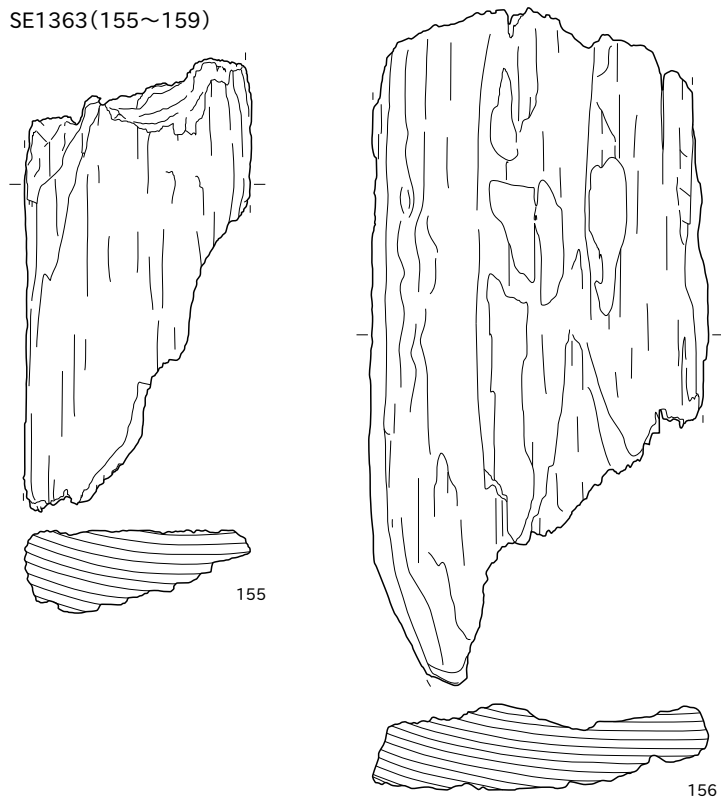

0 (158) 20cm (1:6)

0 10cm (1:3)



160



SE1363(160)

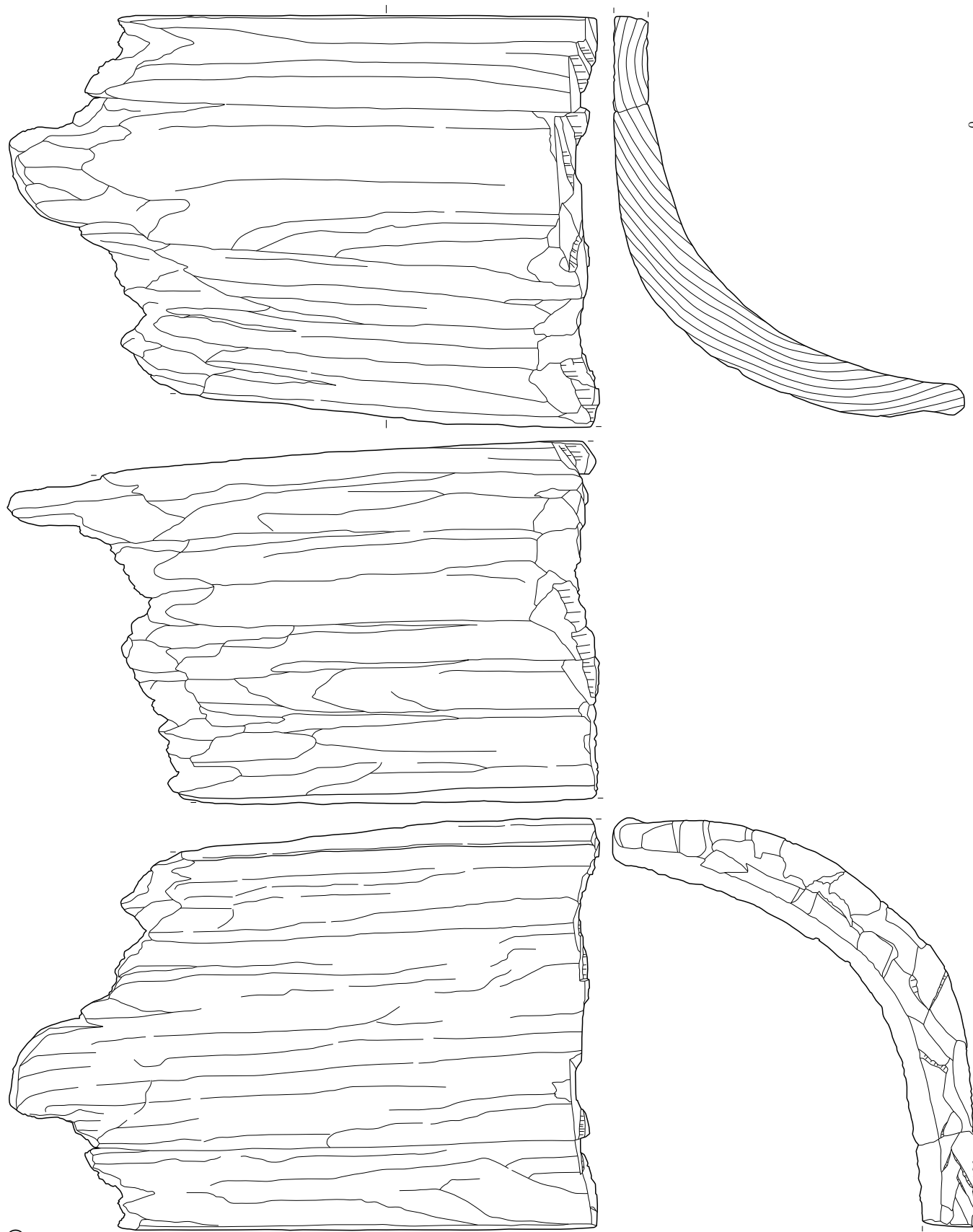

SE1363(161)

SE1363(162~169)

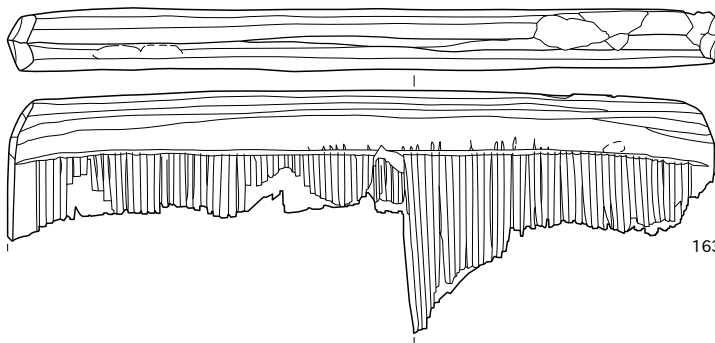
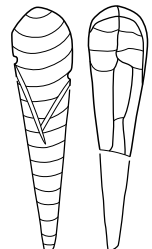

163

SE920(170・171)

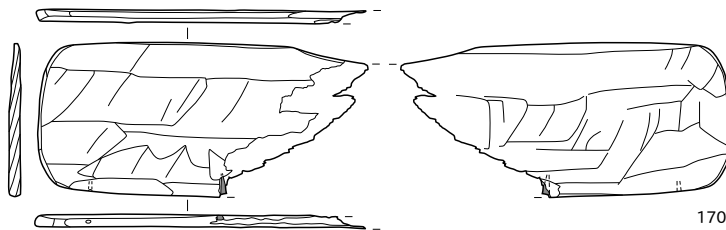

170

162

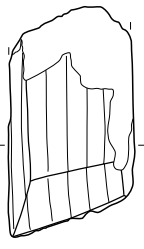
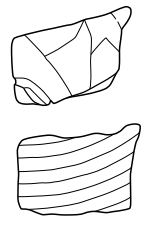

166



167



168



169



SK268(172)

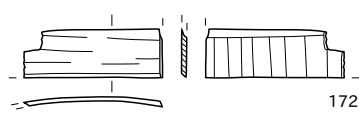

172

SK69(173~175)

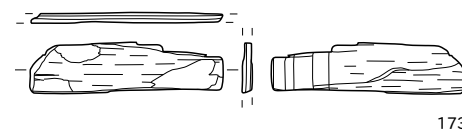

173

174

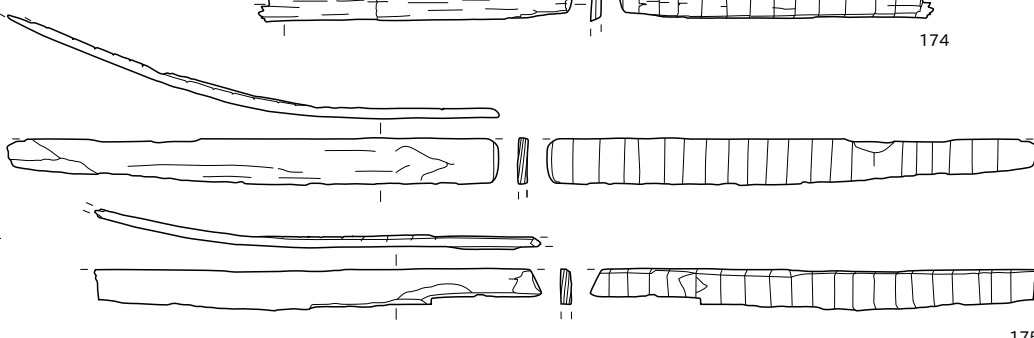

175

165



164

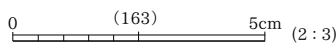

(163)

5cm (2:3)

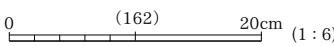

(162)

20cm (1:6)



10cm (1:3)

SK69(176~192)

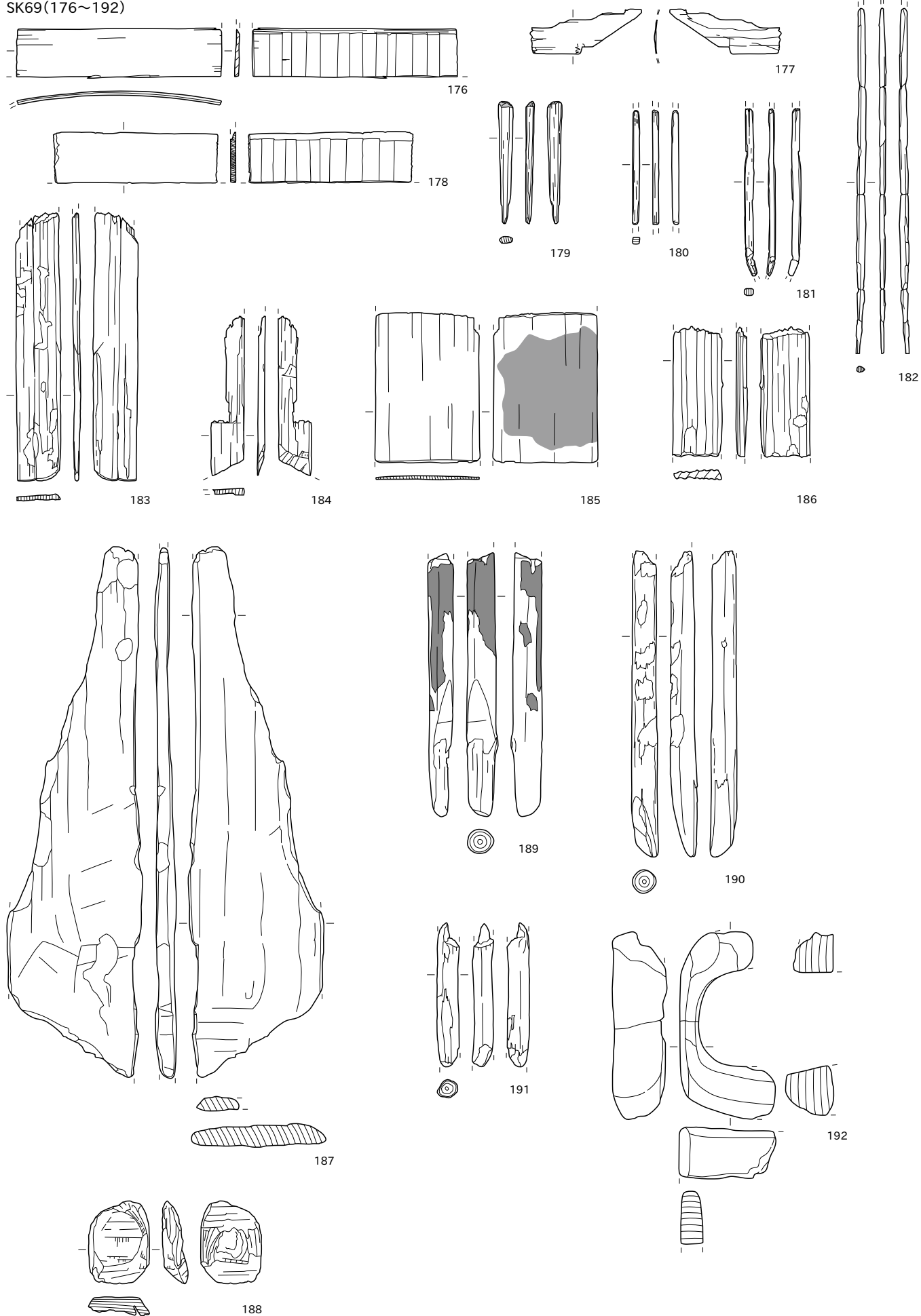

SK83(193)

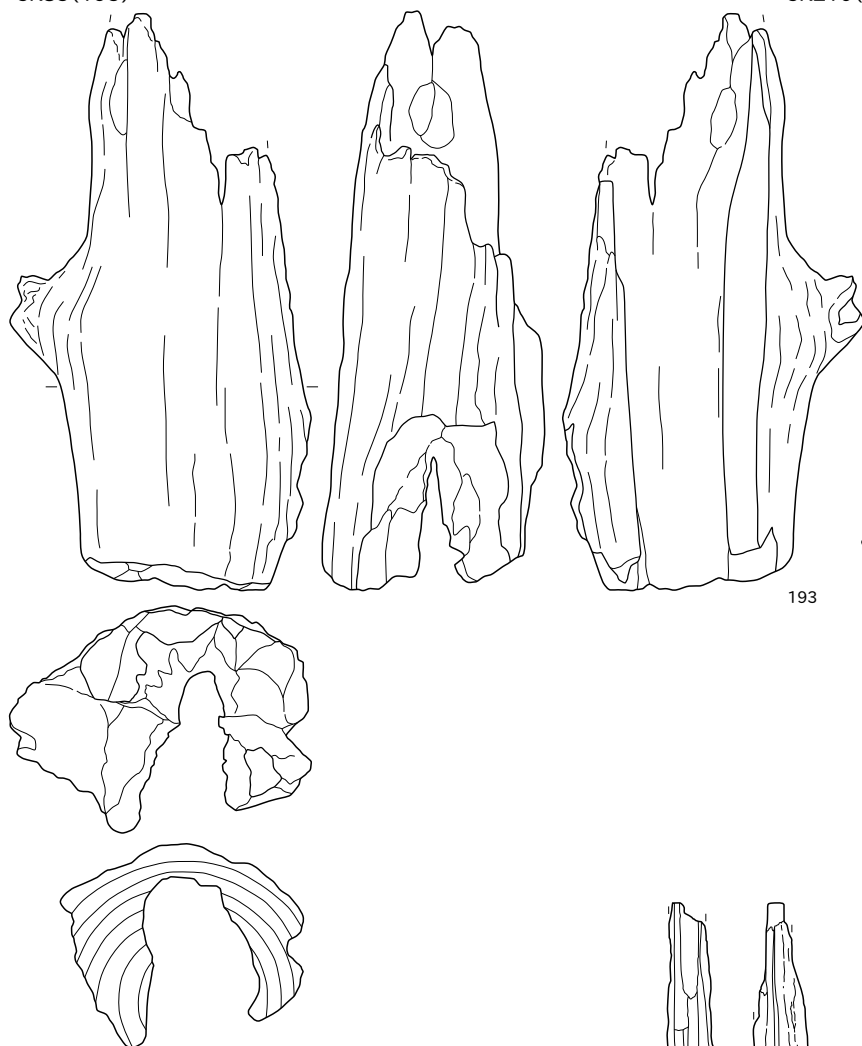

SK210(194)



SK555(195~199)

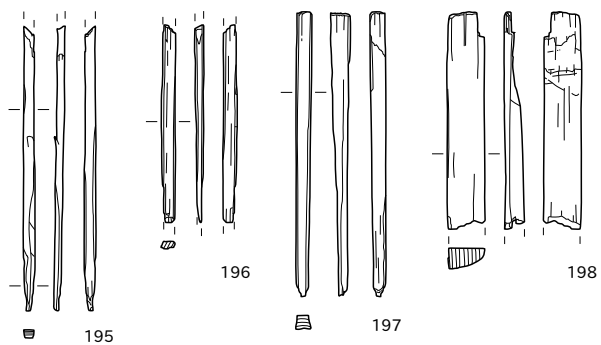

SK1115(200~202)

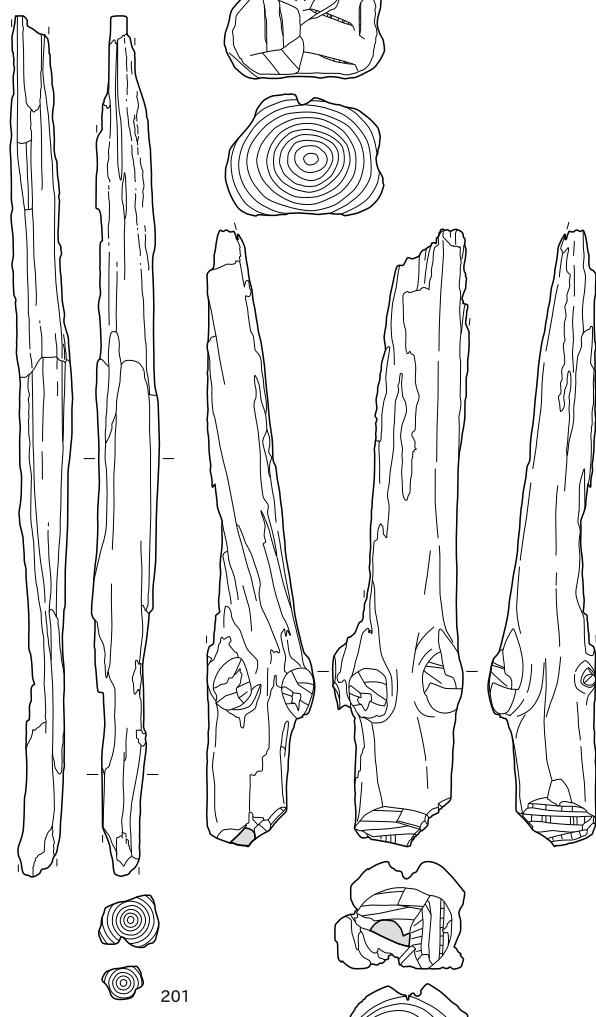
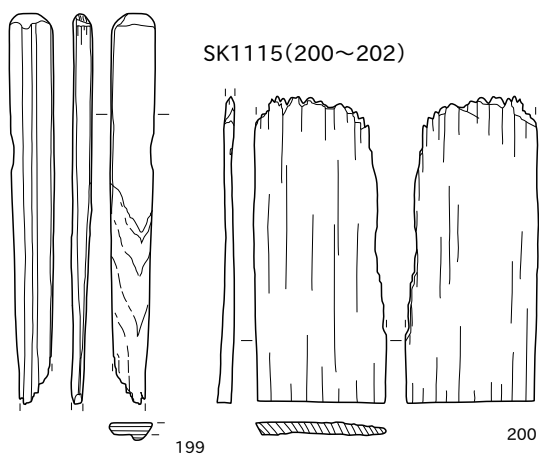

0 (194・201・202) 20cm (1:6) 0 10cm (1:3)

202

SK1115(203~208)

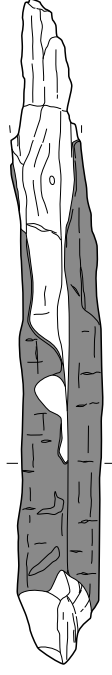
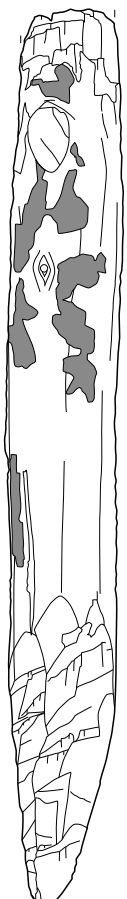
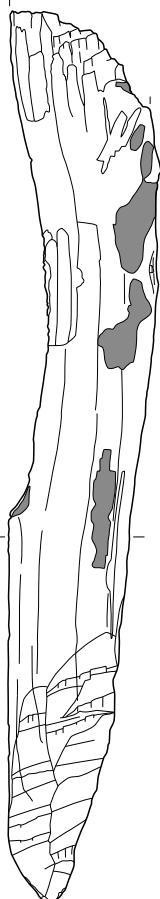

204

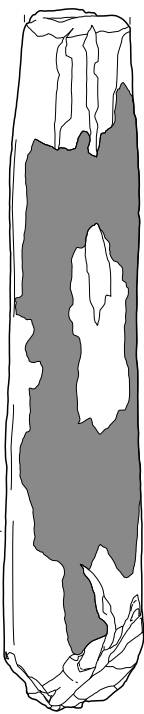
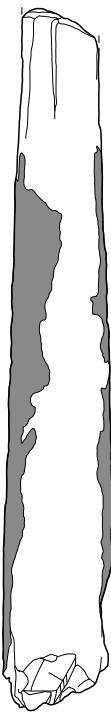

205

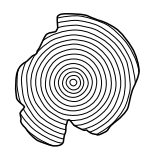
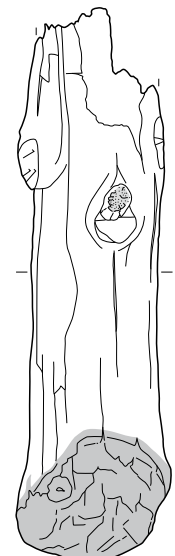

206



207



203

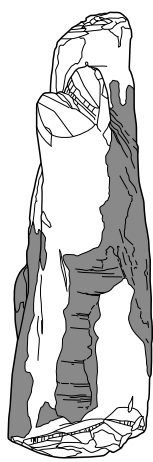
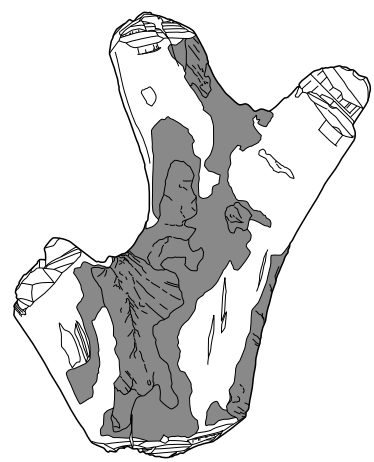

208

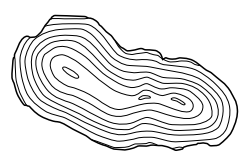
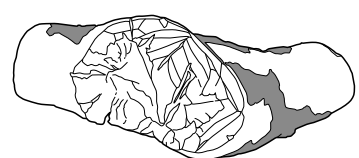

0 (205-208) 30cm (1:8)

0 (203-206-207) 20cm (1:6)

0 (204) 10cm (1:3)

SK1115(209・210)

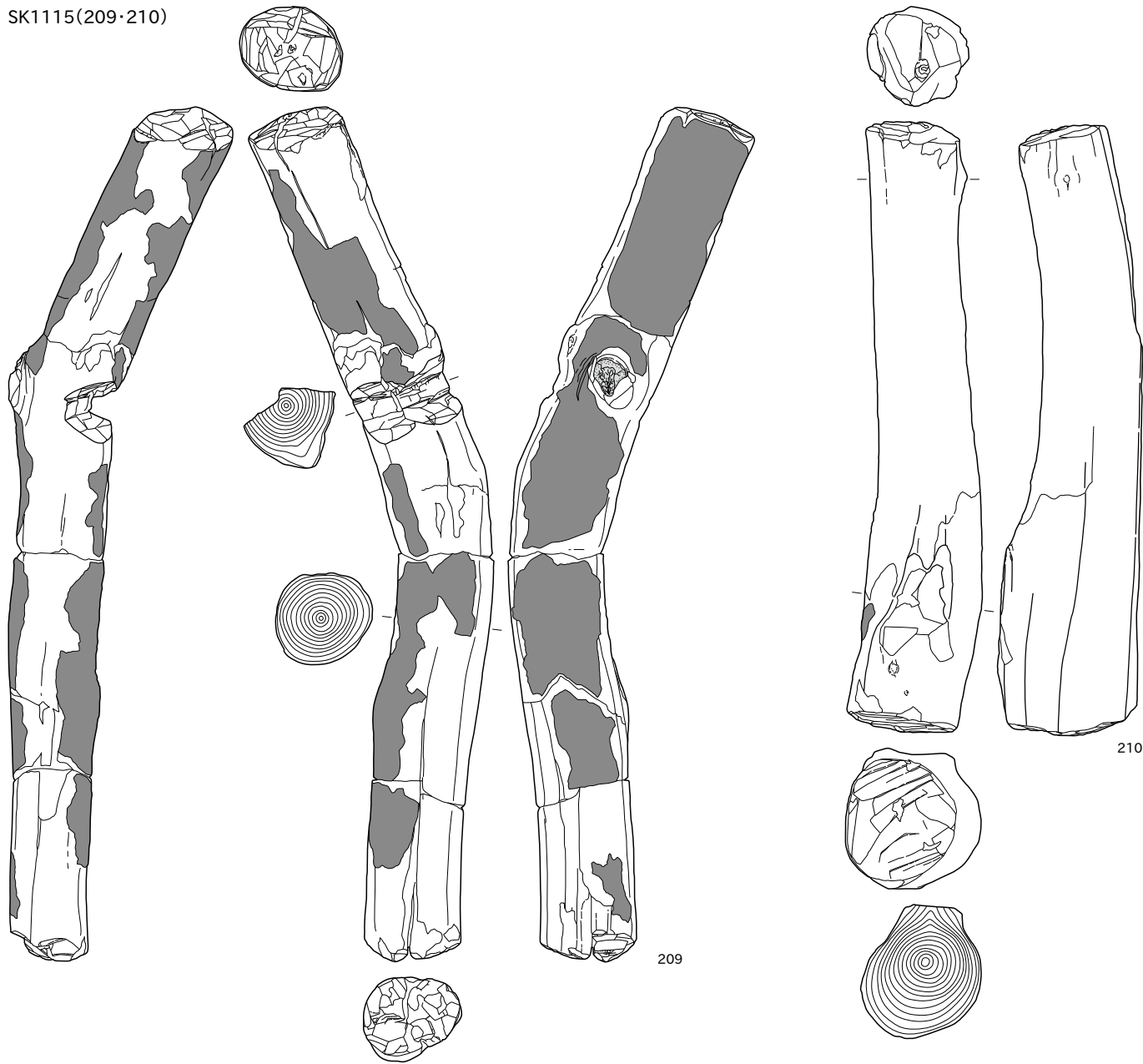

SX275(211~213)

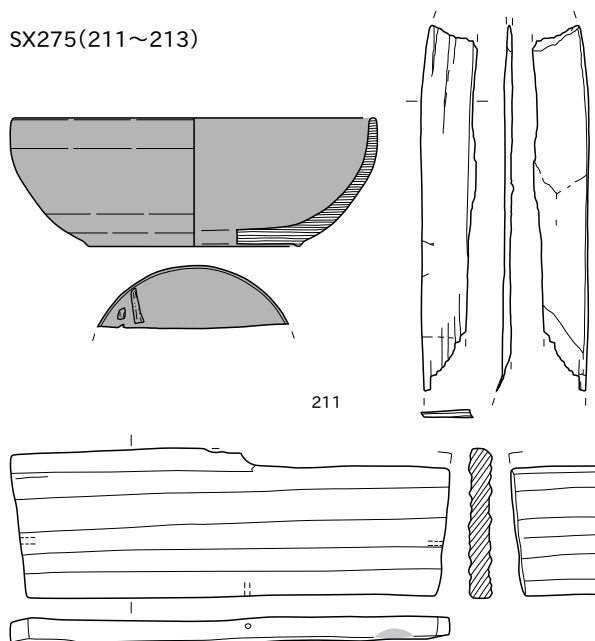

SX227(214~216)

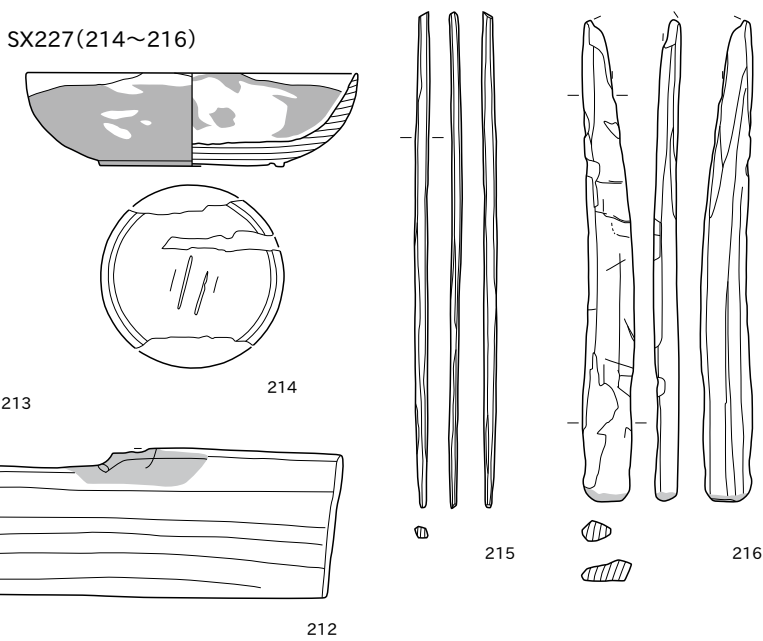

0 (209) 50cm (1:10) 0 (210) 30cm (1:8) 0 10cm (1:3)

SX227(217~220)

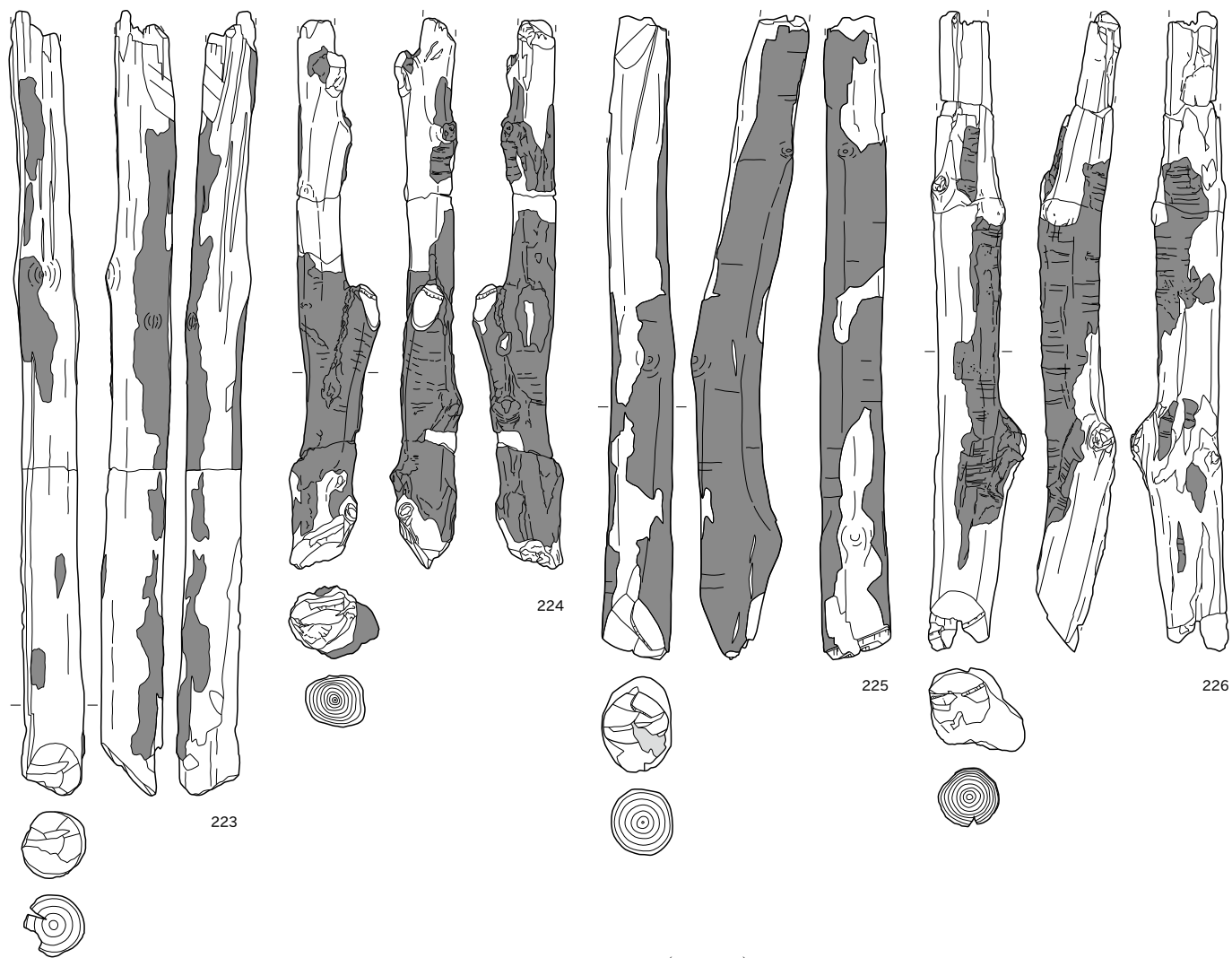
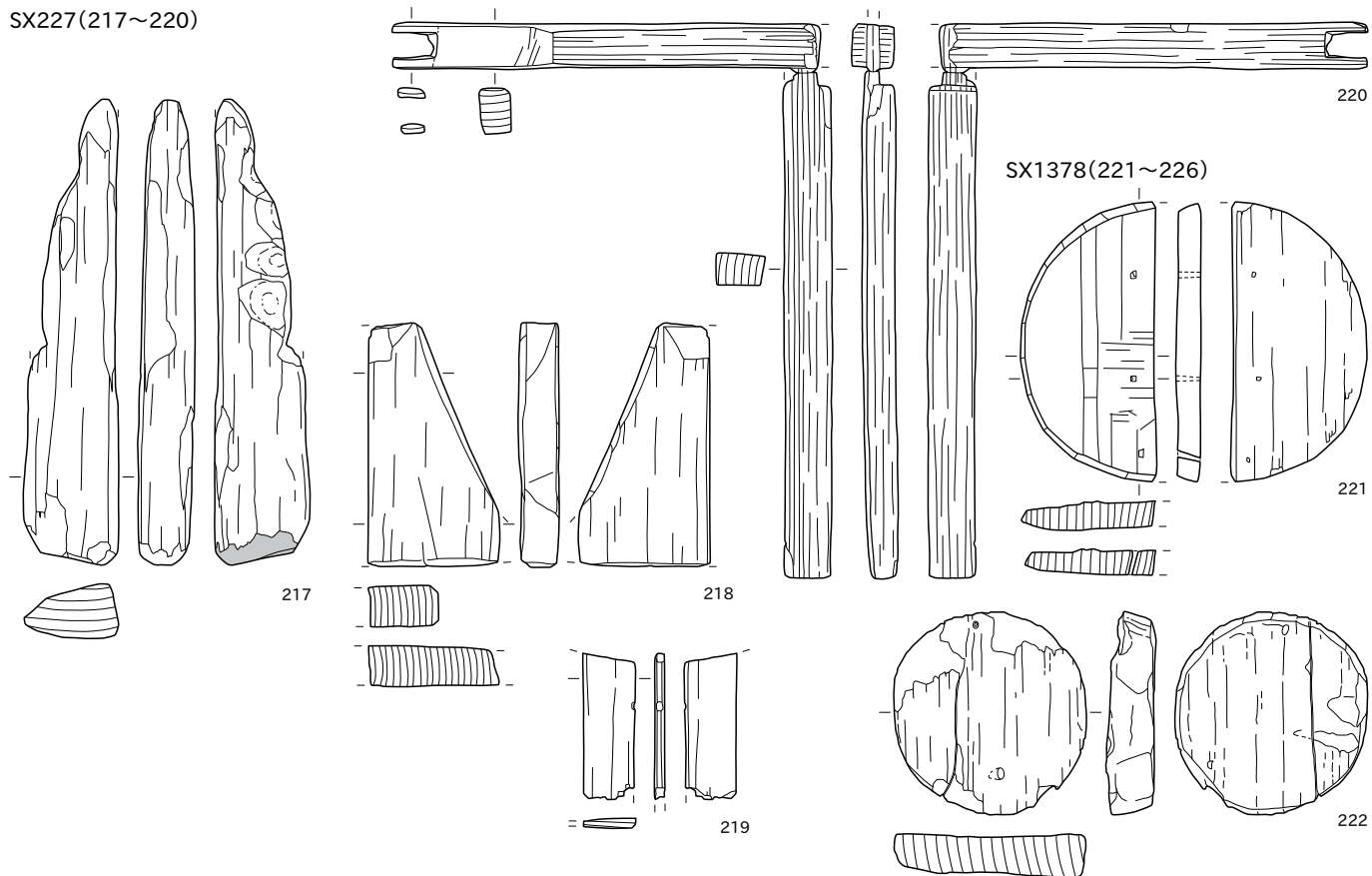

0 (223~226) 30cm (1:8) 0 10cm (1:3)

SX1378(227~231)

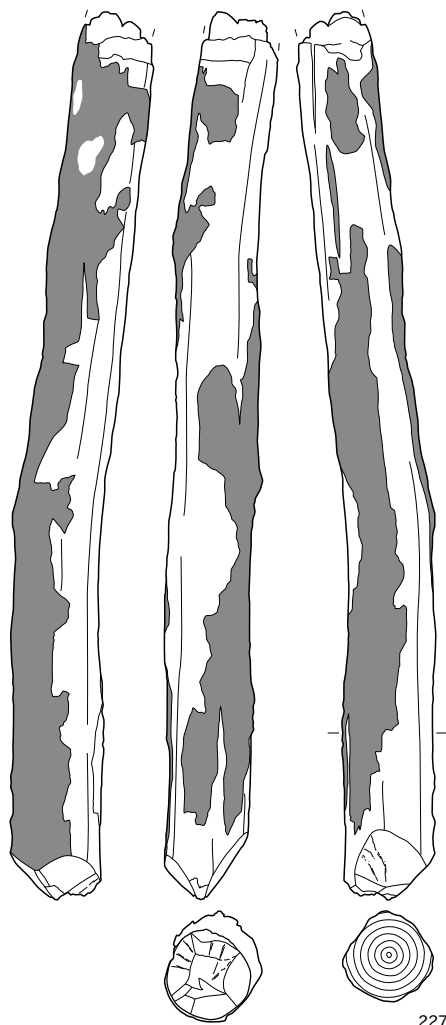

227

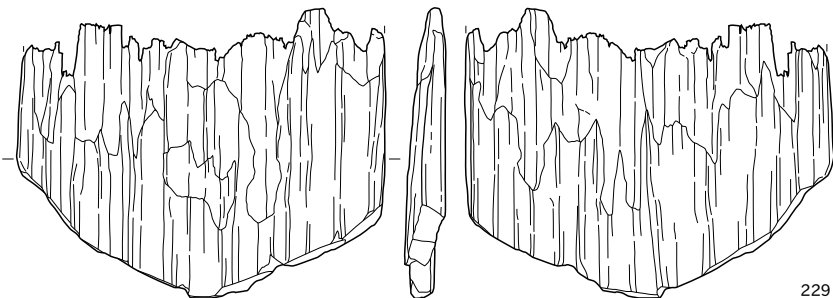

229

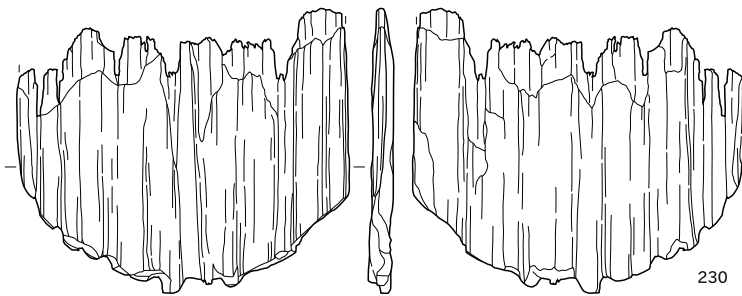

230

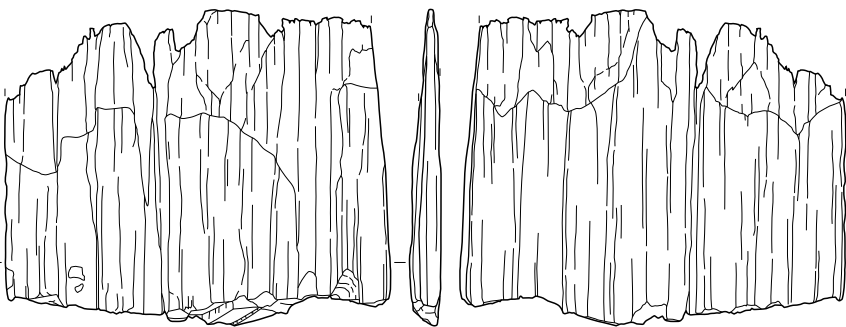

231



SX473(232)

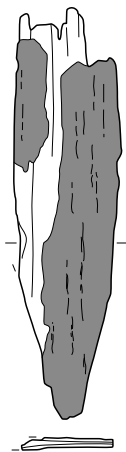

228



232

0 (227) 30cm (1:8)

0 (229~231) 20cm (1:6)

0 (228・232) 10cm (1:3)

SX950(233~239)



233

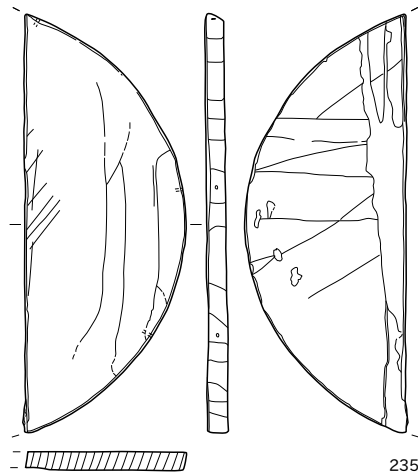

235

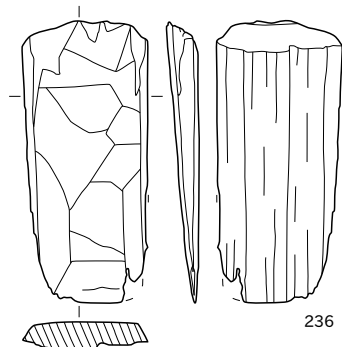

236

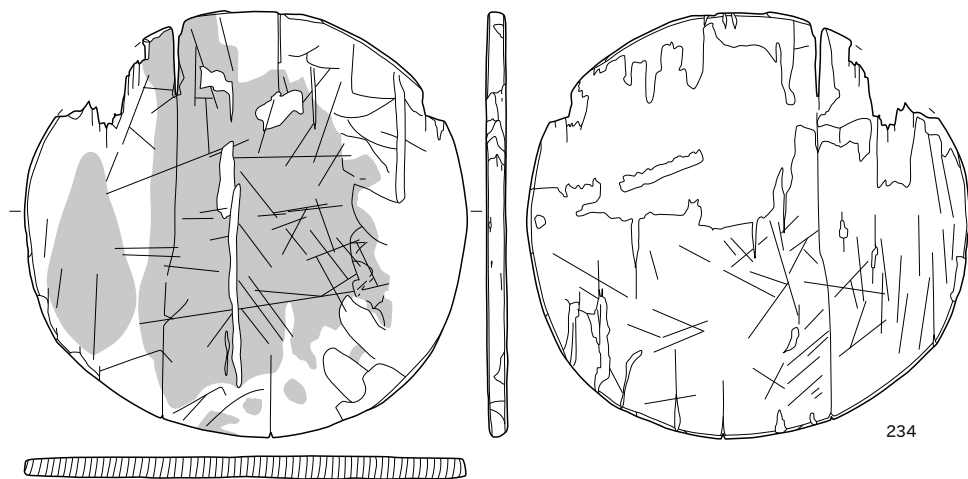
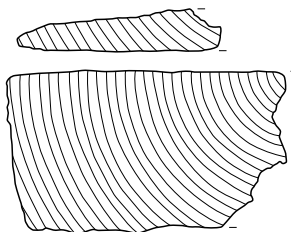

234

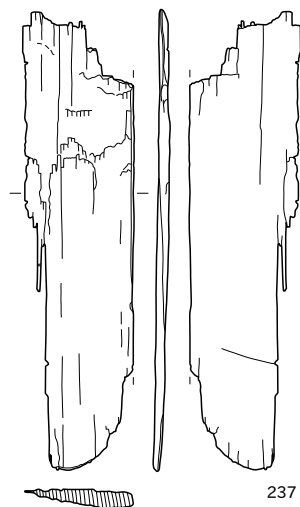

237

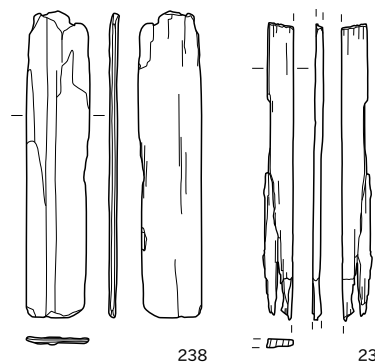

238

239

SX950(240~250)

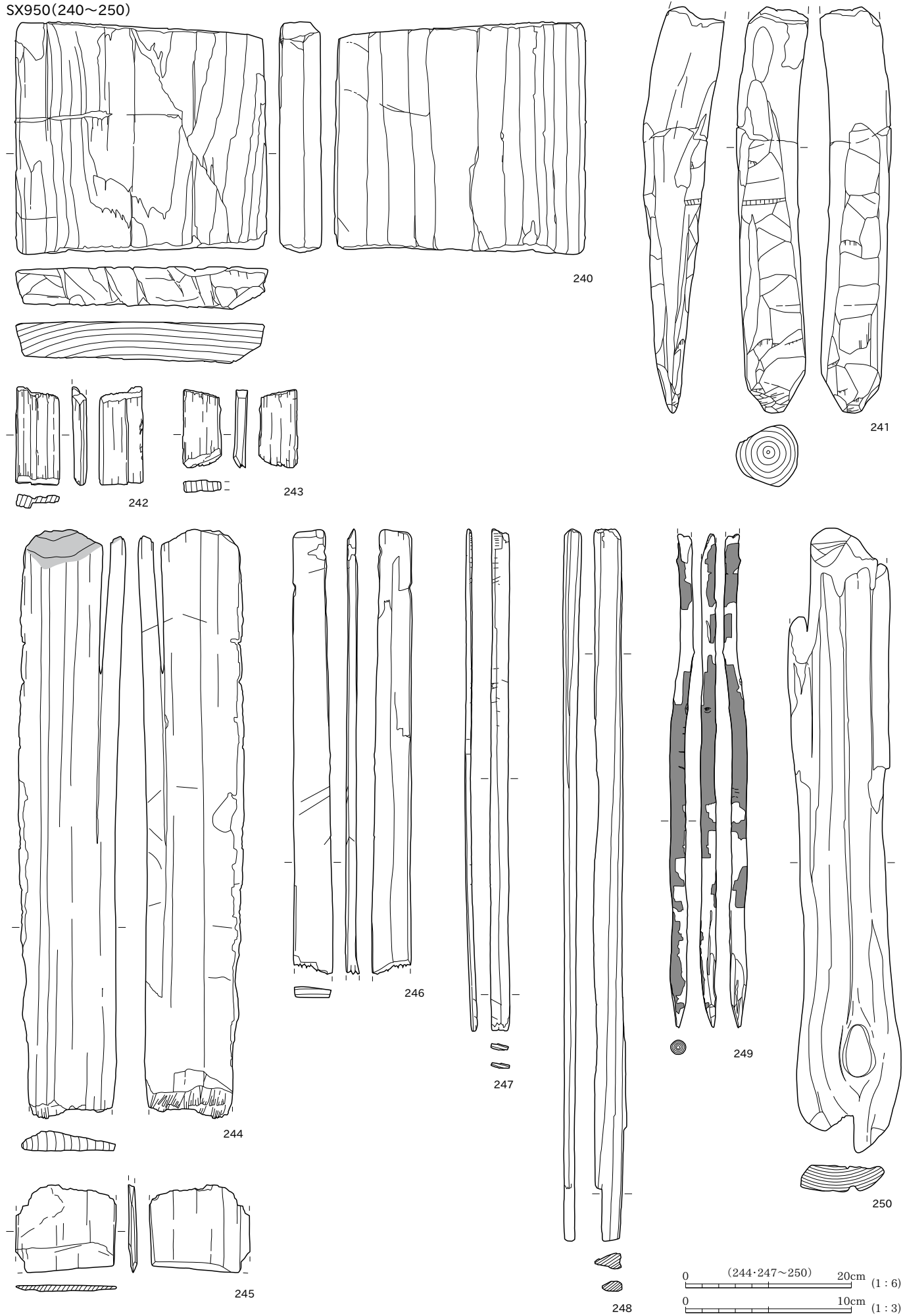

SX950(251~256)

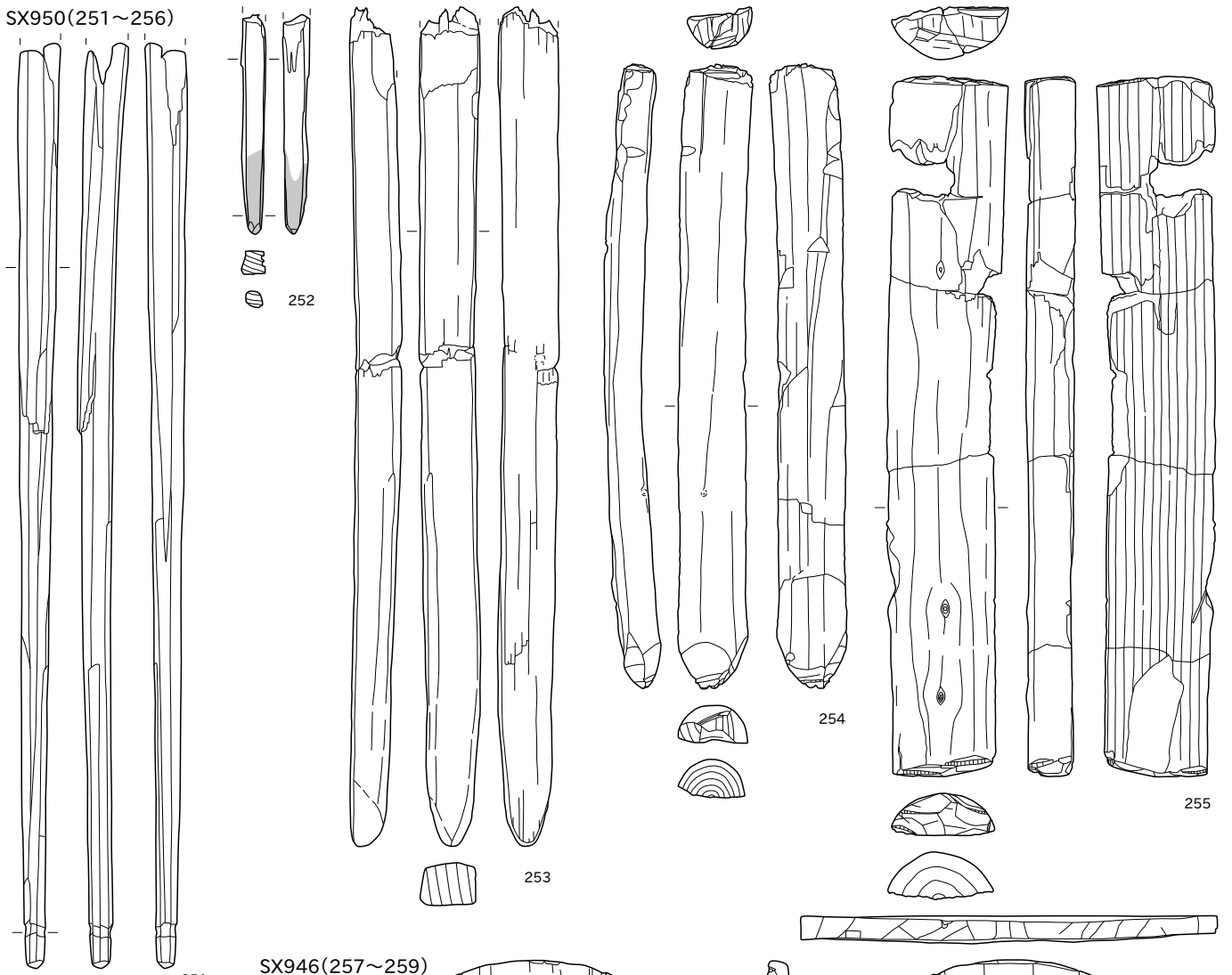

SX946(257~259)

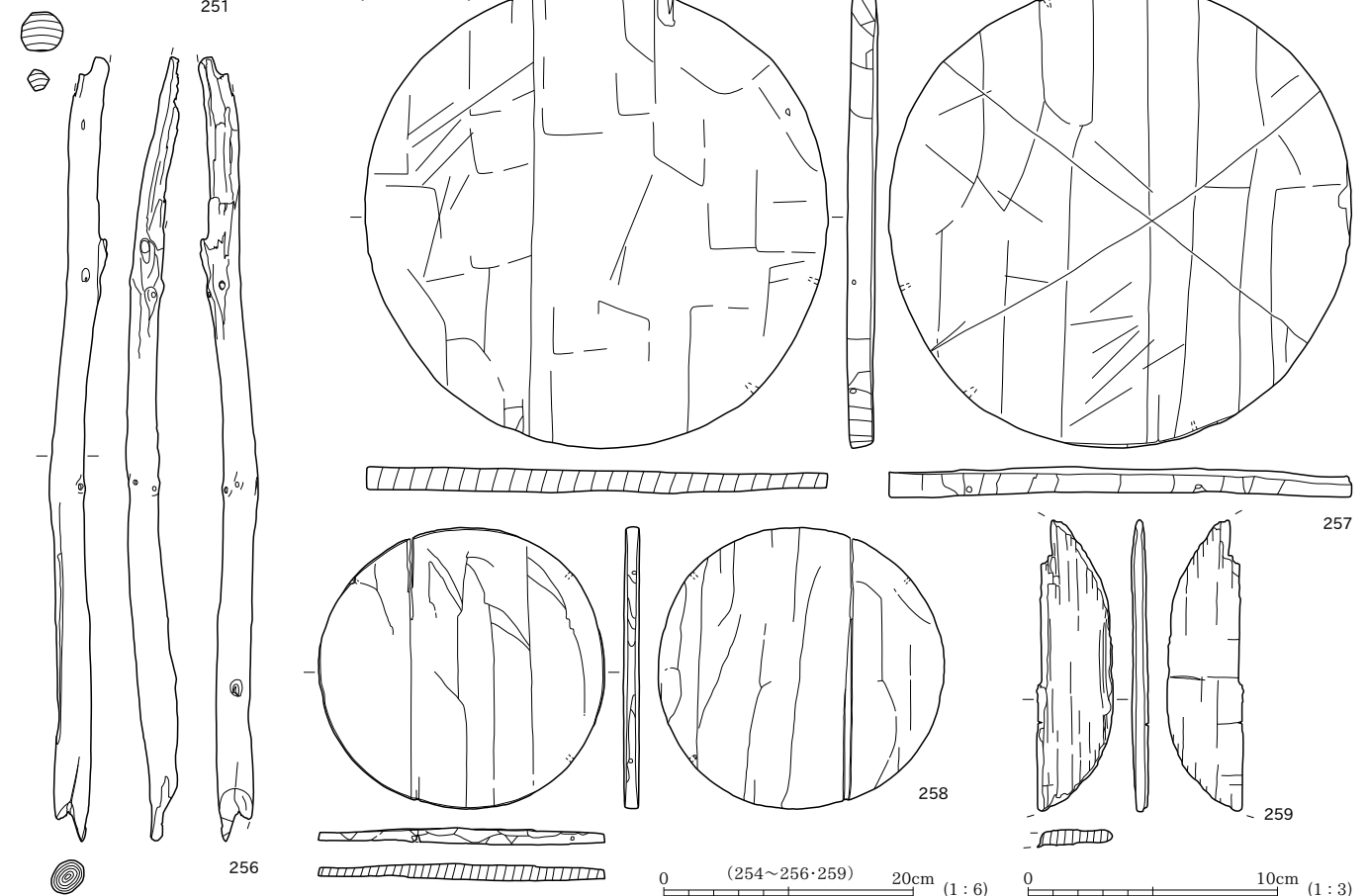

0 (254~256・259) 20cm (1:6)

0 10cm (1:3)

SX946(260~266)

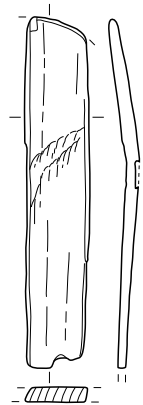

260

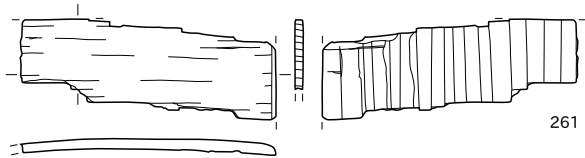

261

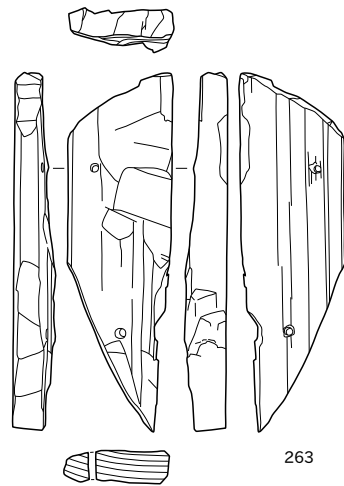

263

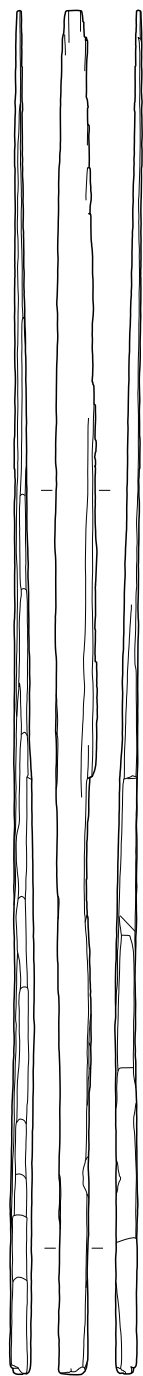

262



264



265



266

0 (262・264・265) 20cm (1:6) 0 (260・261・263) 10cm (1:3)

SX946(267)

SX947(268~272)

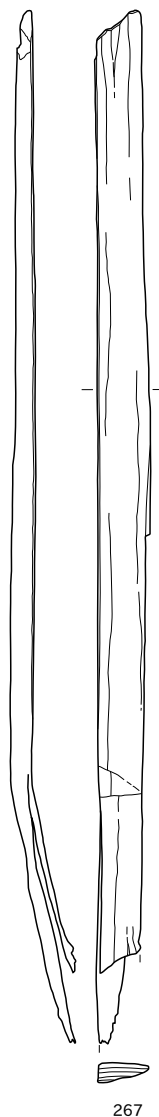

267

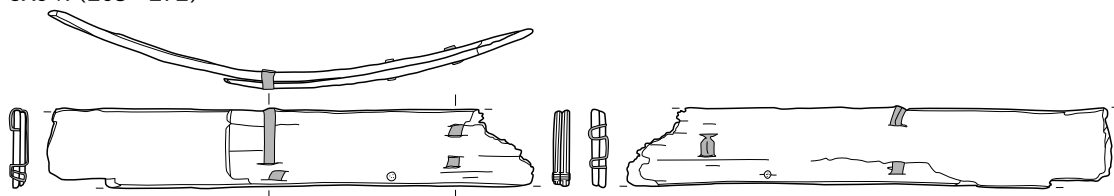

269

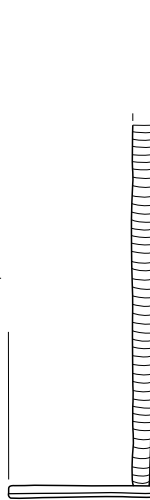
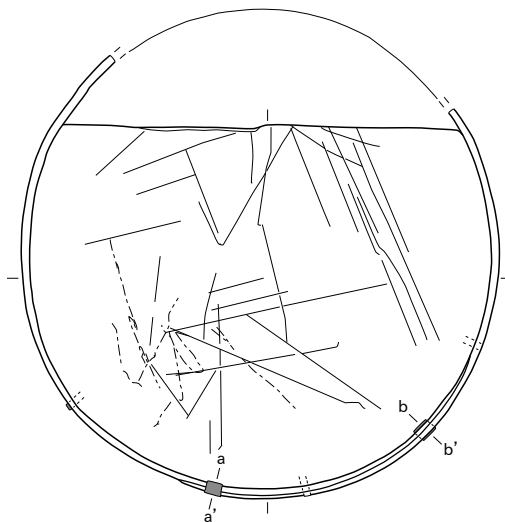

270

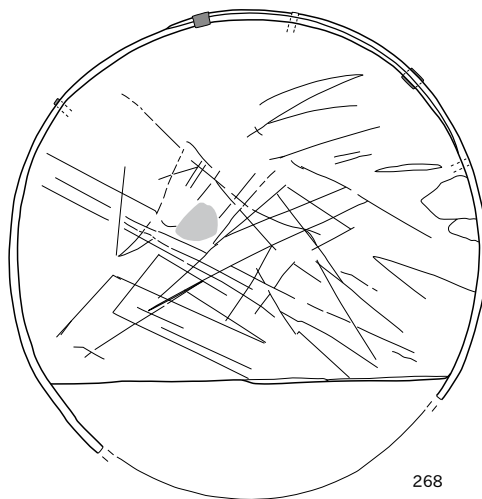
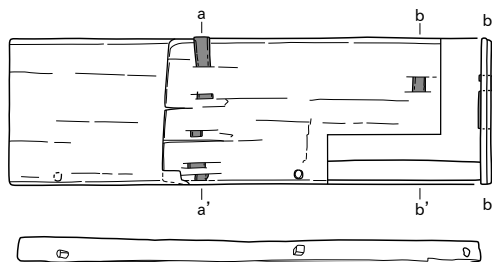
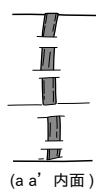

268

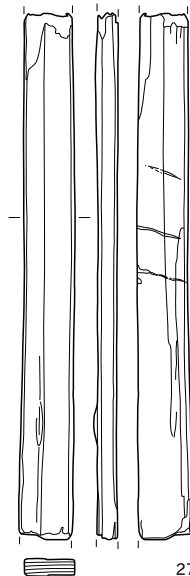

271

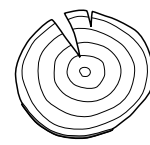
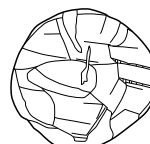
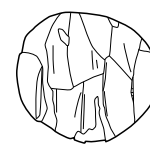

272

0 (272) 20cm (1:6)

0 10cm (1:3)

SX947(273~278)

SX951(279~282)

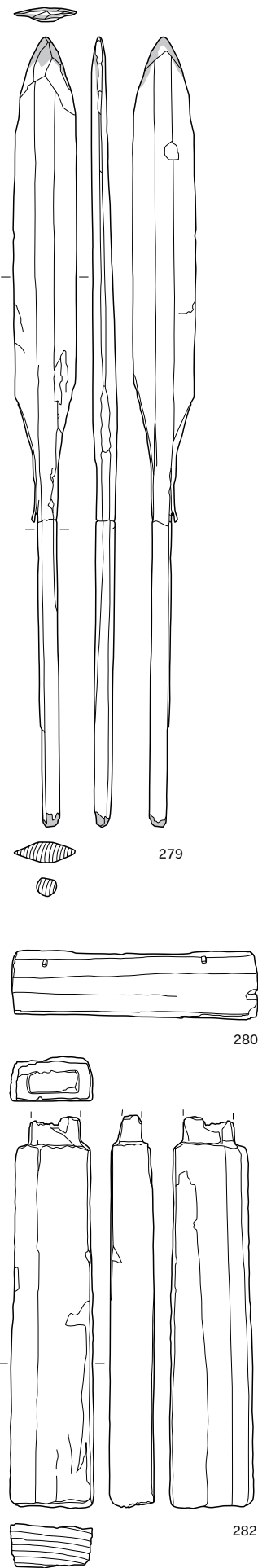
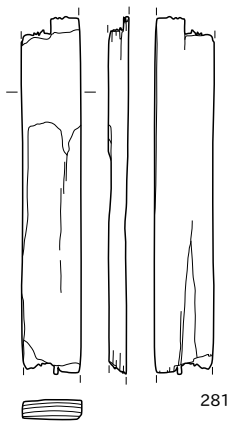
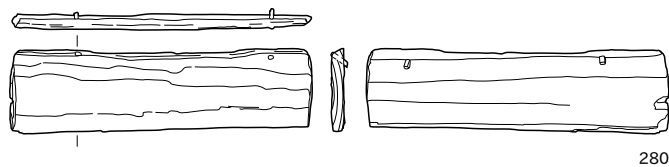
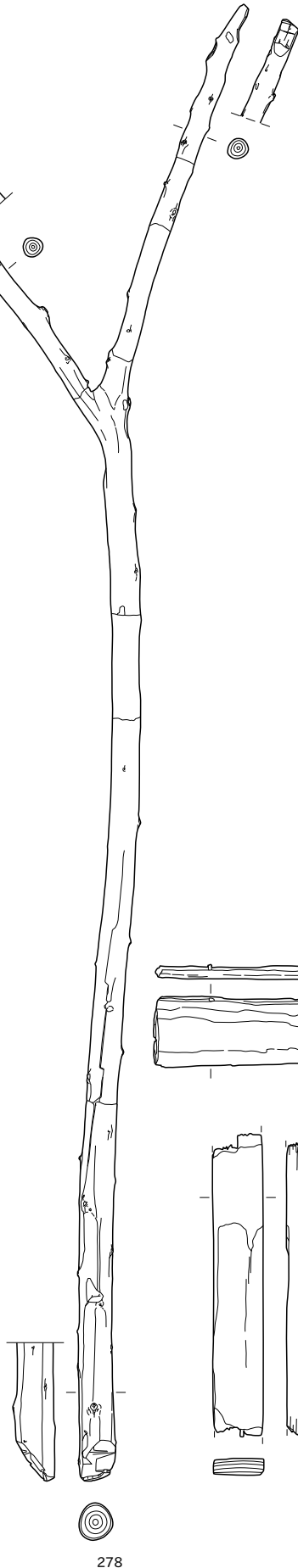
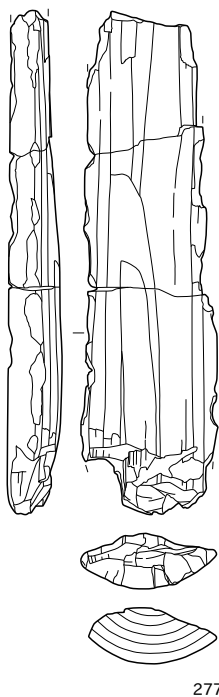
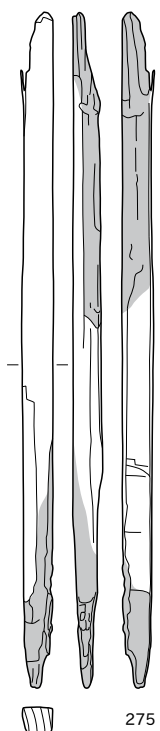
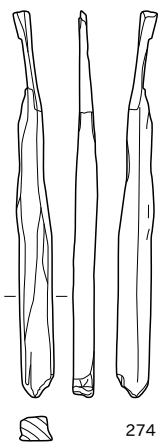

0 (278) 30cm (1:8)

0 (277・280) 20cm (1:6)

0 10cm (1:3)

SX951 (283~289)

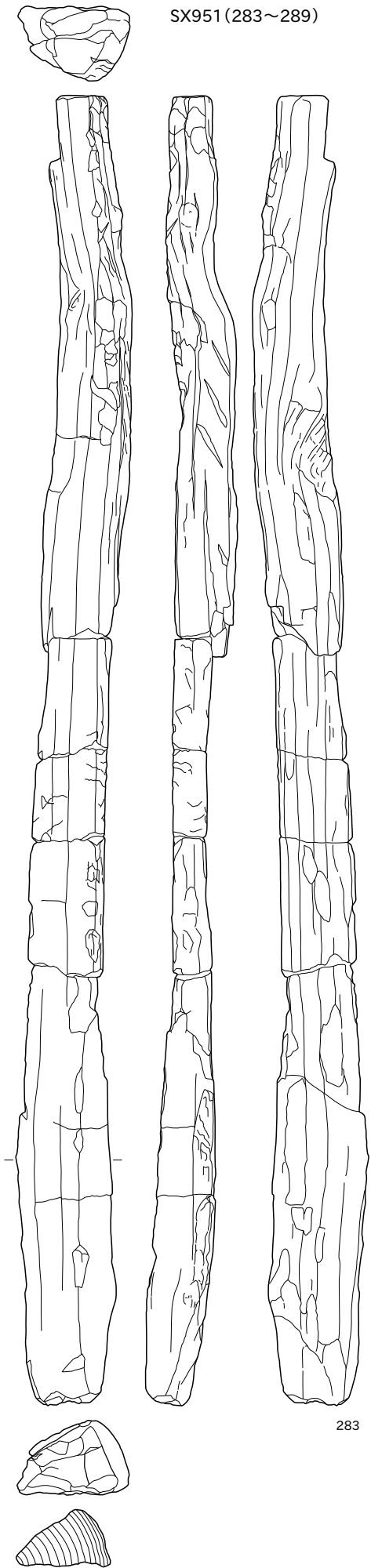

283

284

285

286

287

288

289

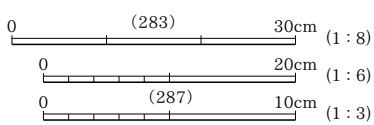

SX945(290・291)

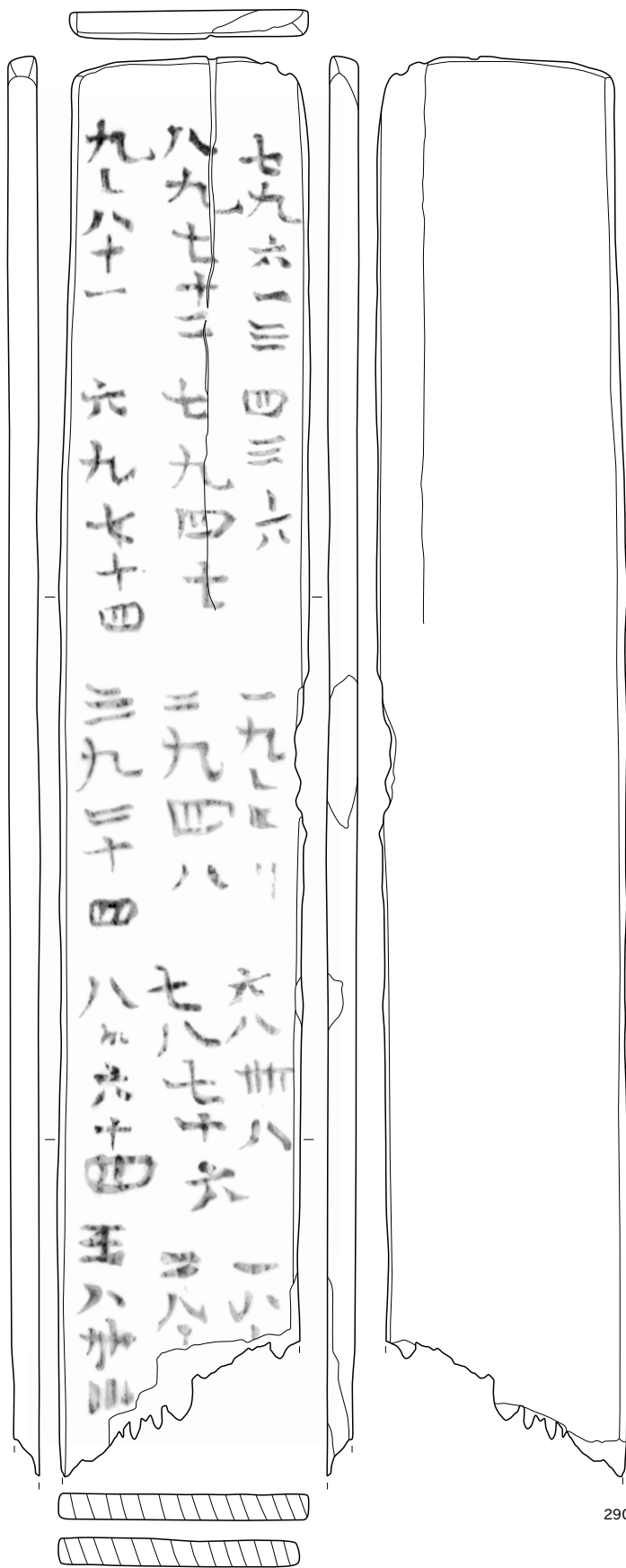

0 (290) 3cm (1:1) 0 (291) 10cm (1:3)

SX945(292~294)



292

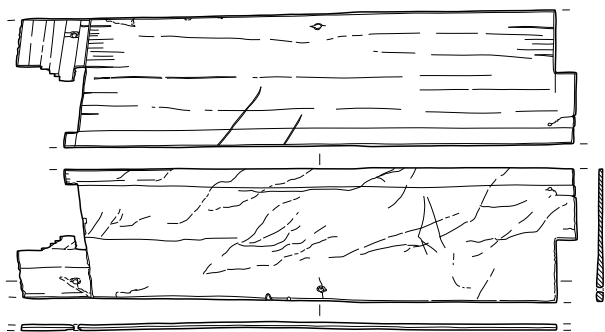
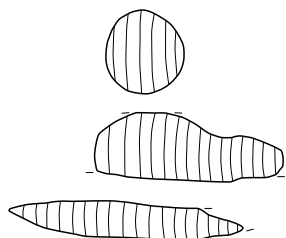

293

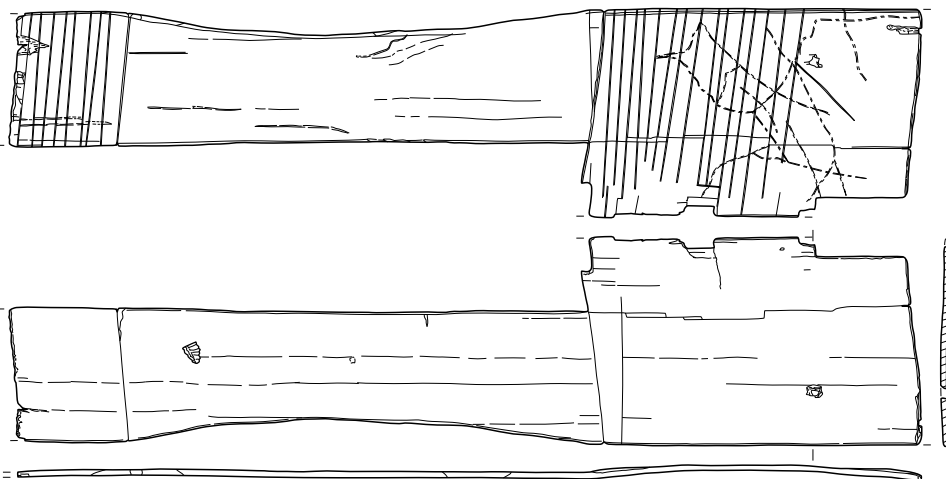

294

0 (293·294) 20cm (1:6)

0 (292) 10cm (1:3)

SX945(295~303)

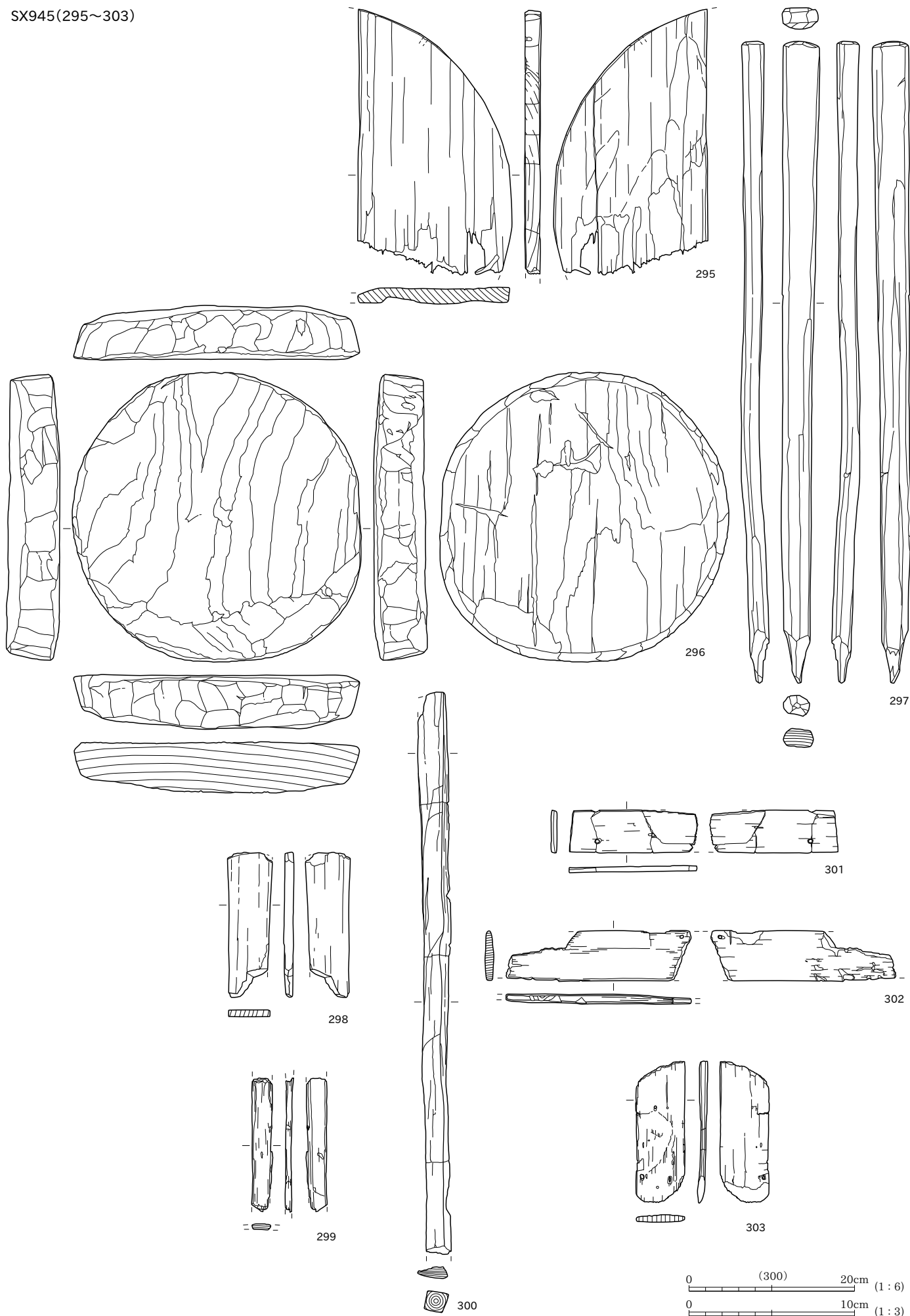

SX945(304~308)

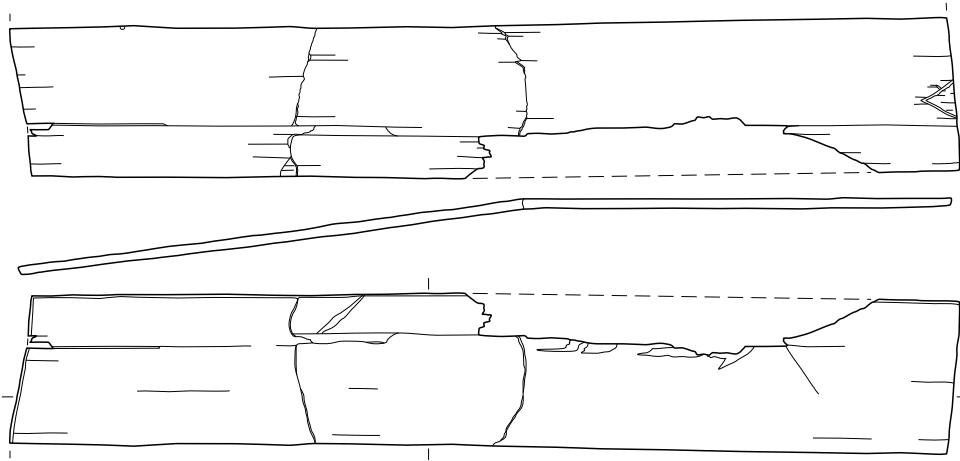

304

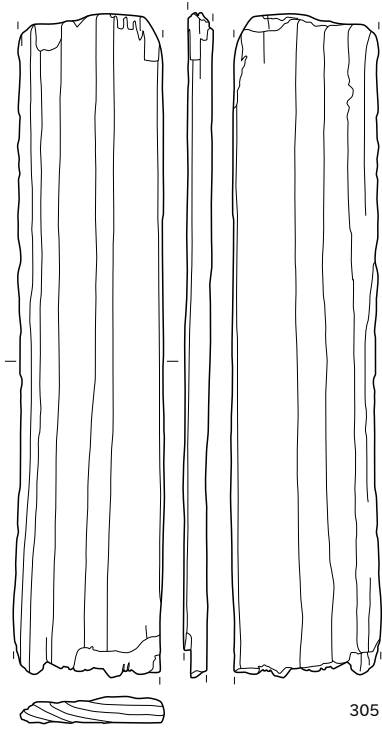

305

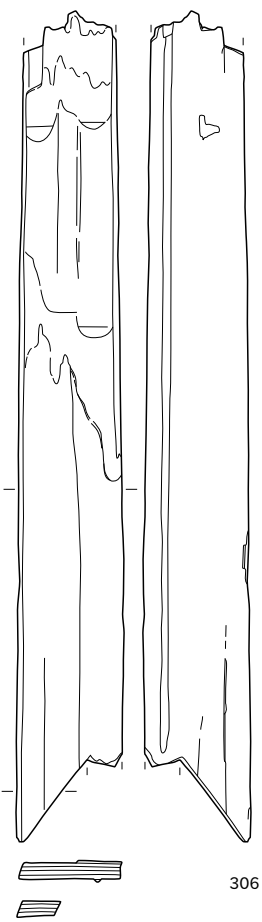

306

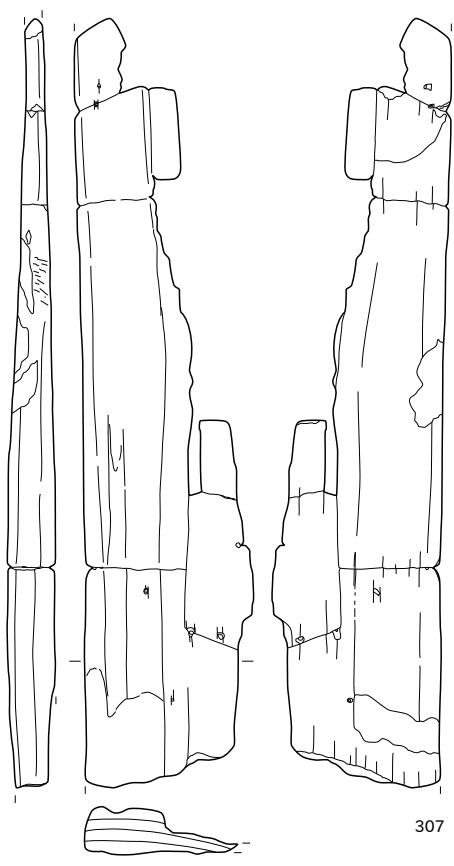

307

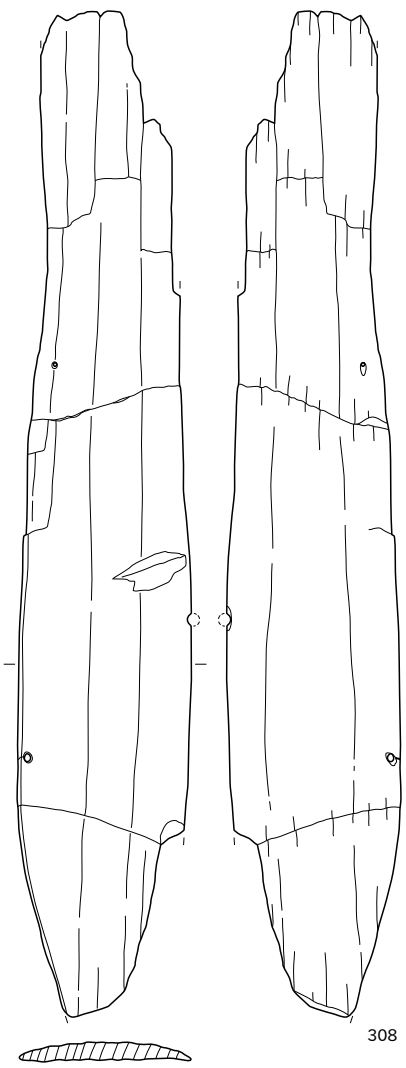

308

SX945(309~316)

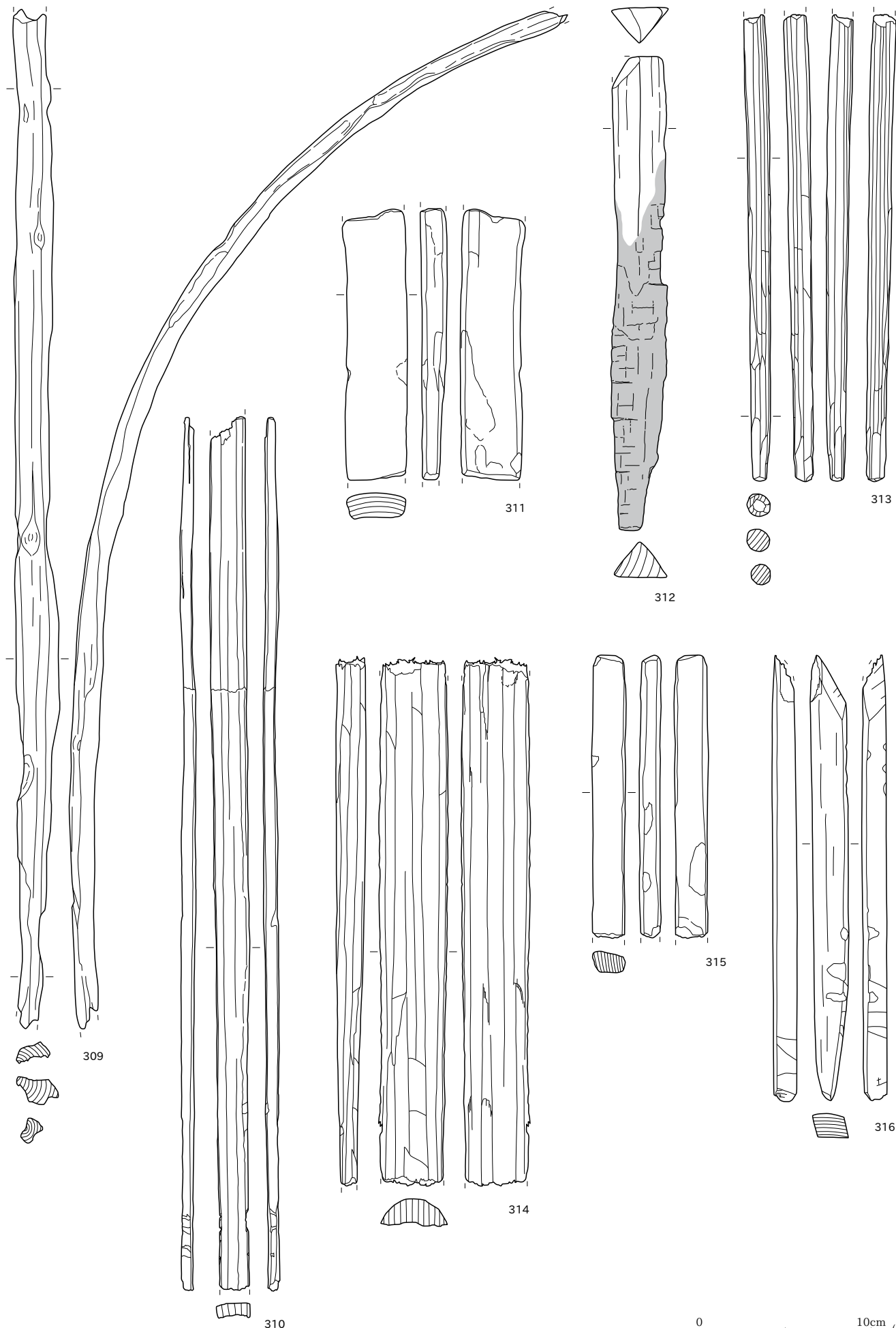

0 10cm (1:3)

SX948(317~319)

3K-5A・5B(323)

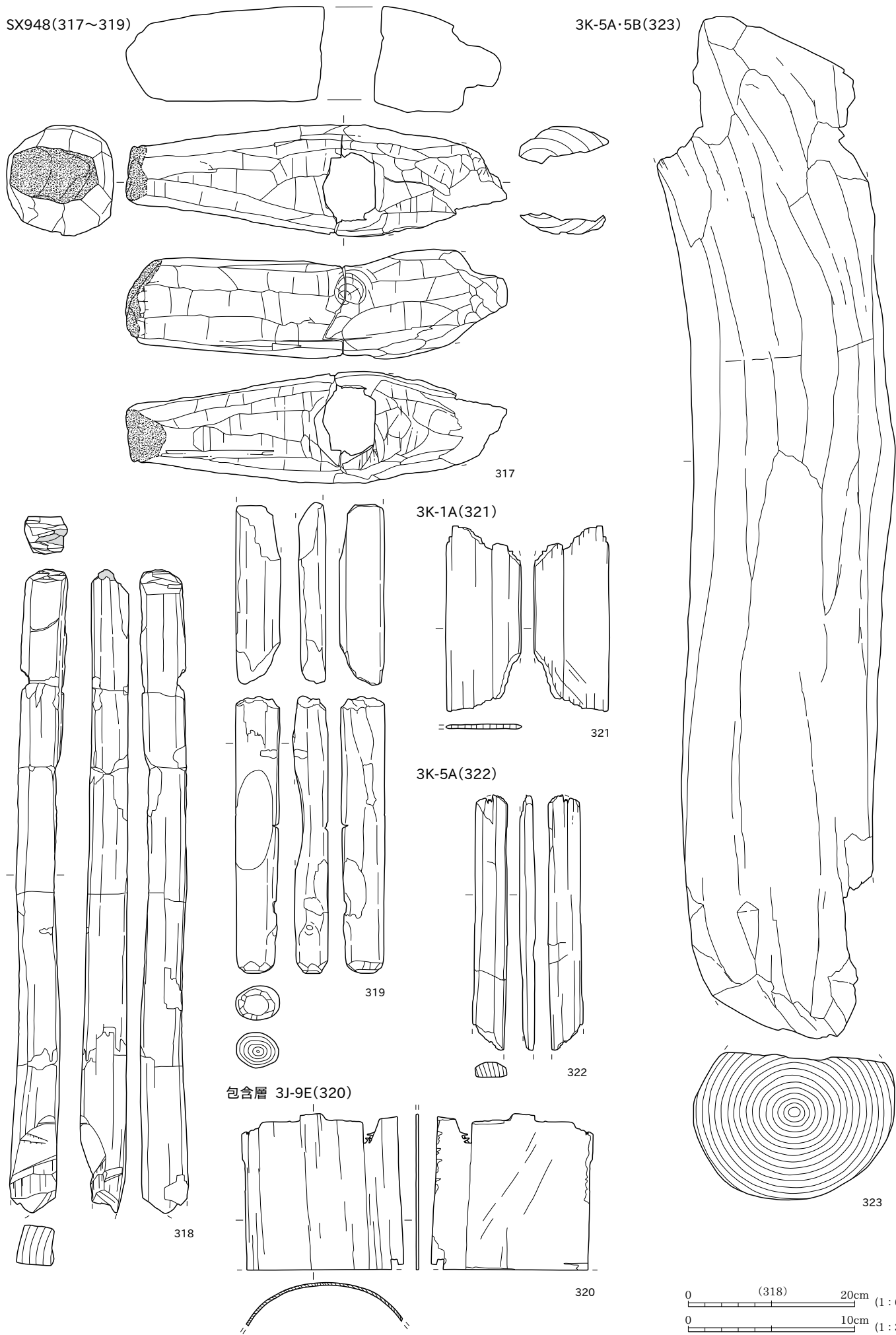

317

3K-1A(321)

3K-5A(322)

包含層 3J-9E(320)

318

319

321

322

320

323

0 (318) 20cm (1:6)

0 10cm (1:3)

4J-4C(324)

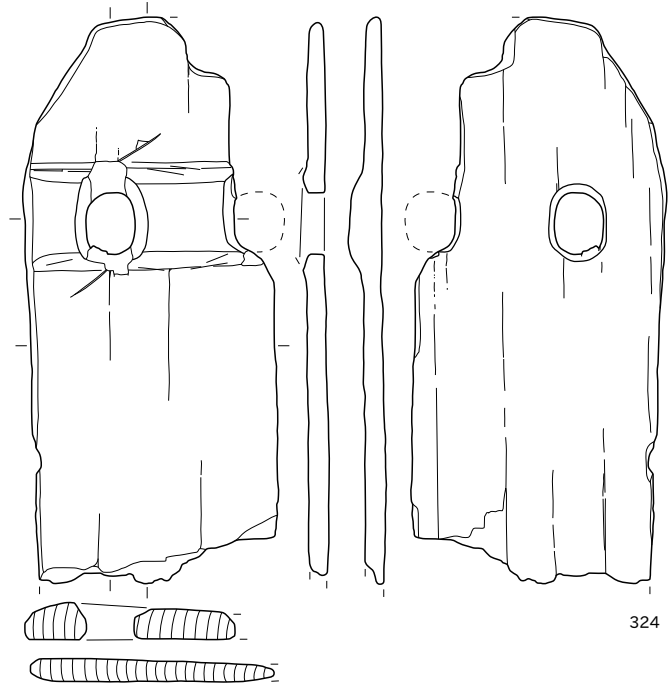

324

4J-4G(325)

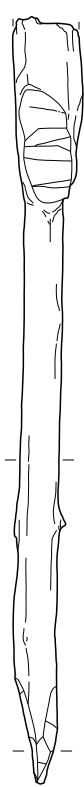

325

4J-5A(326-327)

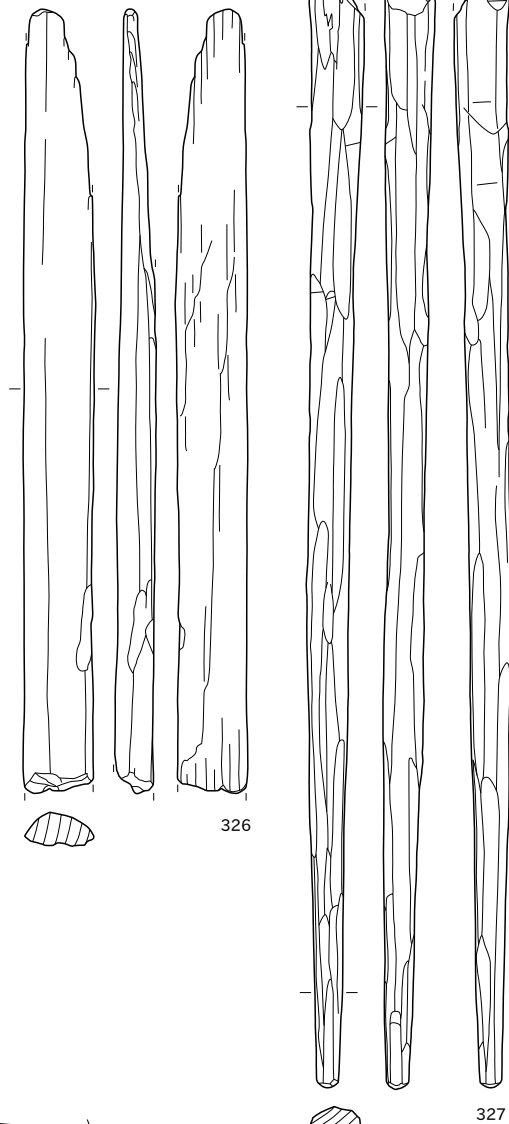

326

327

グリッド不明(328)

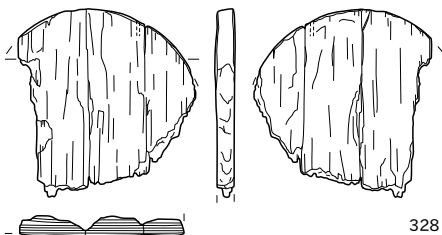

328

河138(329-330)

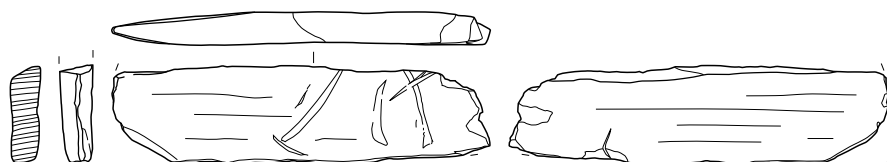

329

330

攪乱(331)

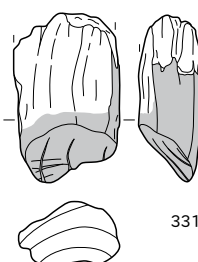

331

南谷部(332-333)



332

333

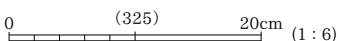

南谷部(334~337)

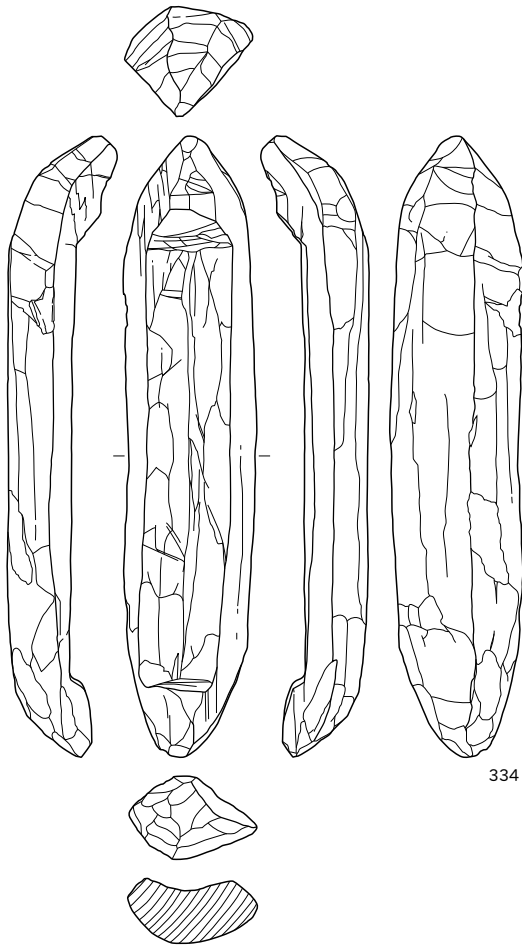

334



337

黒溝直上(338)

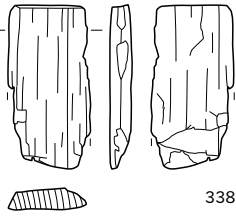

338

溝直上(339)

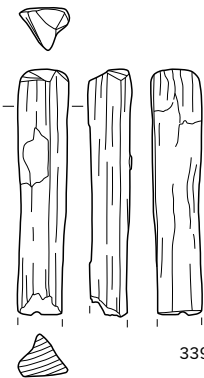

339



335



336

遺構外(340~342)

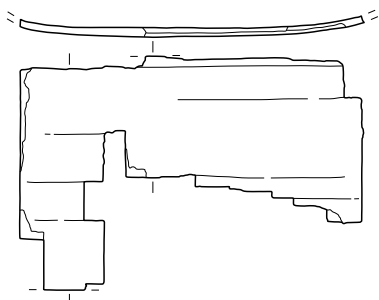

340

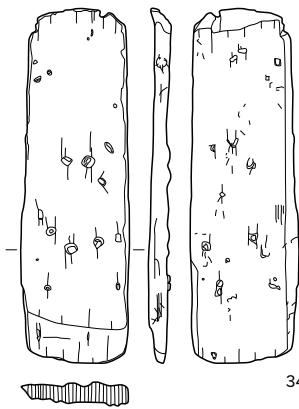
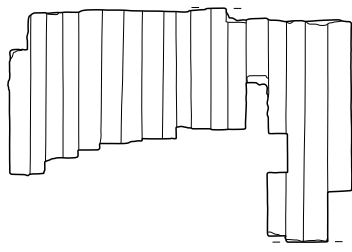

341

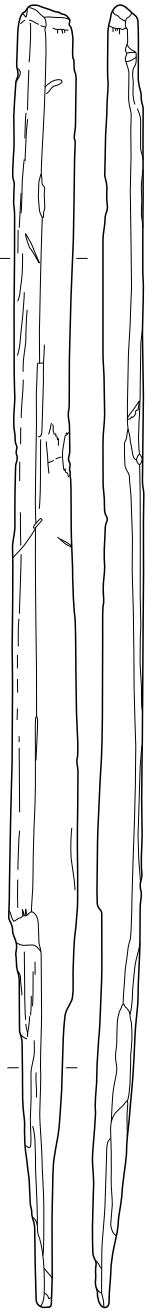

342

SD76・155・158、SE542・853・987、SK503・555・1115・1500、SX951、包含層
SD76(1) 4J-3D(2) SD155(3)

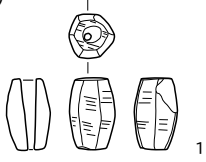

1

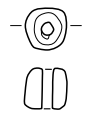

2

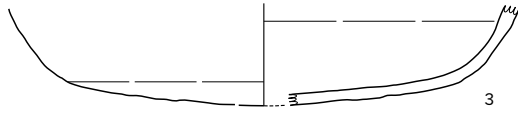

3

SD158(4)

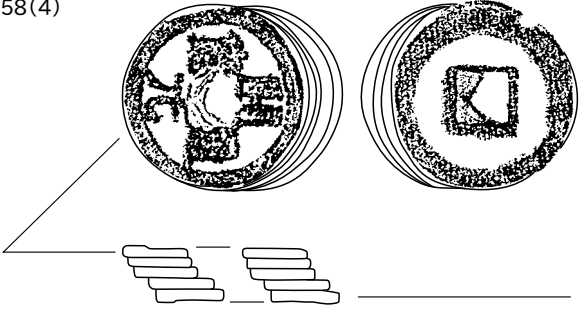

SE542(5)



5

SE853(6)

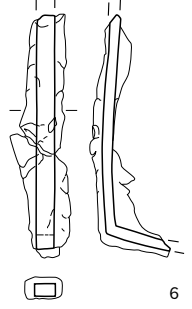

6

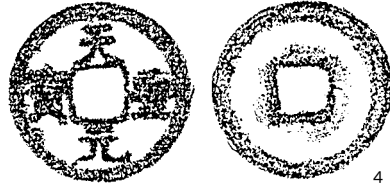

4

SE987(7)

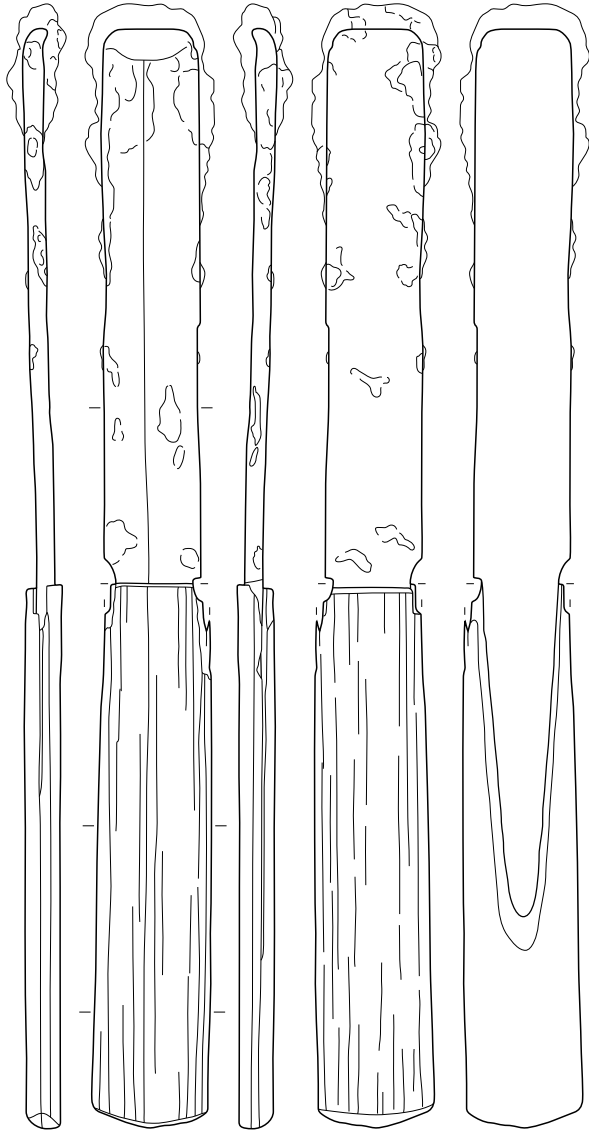

7

SK503(8)

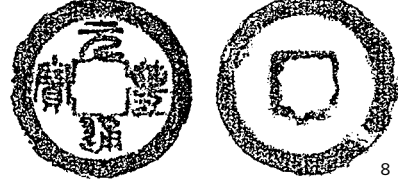

8

SK555(9)

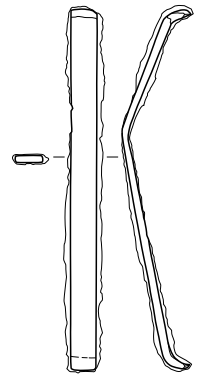

9

SK1115(10)

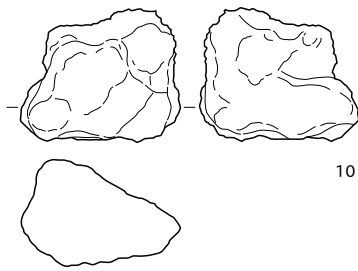

10

SK1500(11)

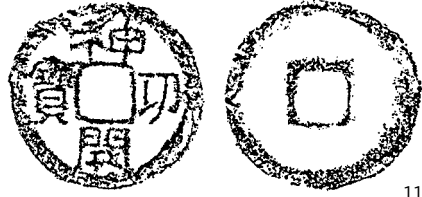

11

SX951(12)

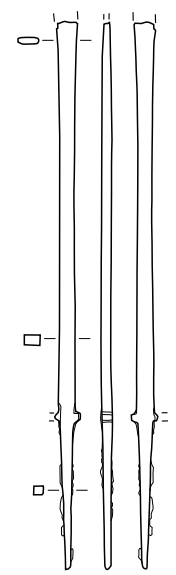

12

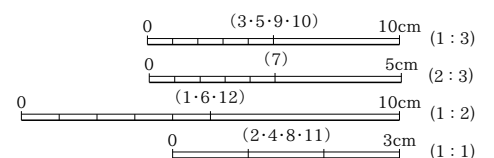
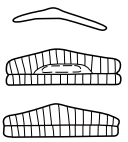

SX945(13)

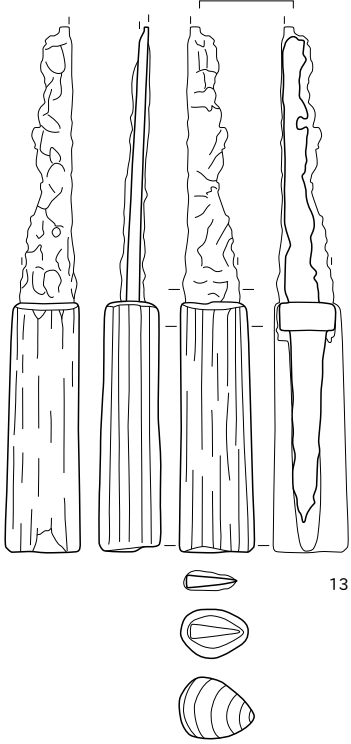

13

包含層 3J-6H(14)

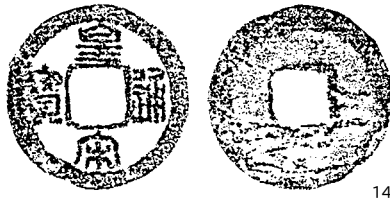

14

3J-7I(15)

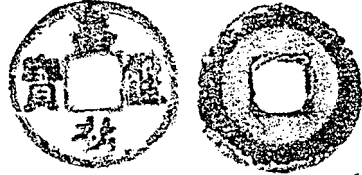

15

河138(17・18)

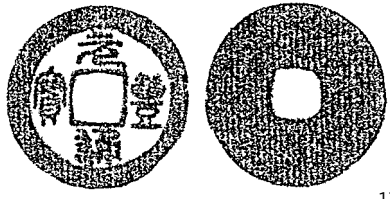

17

3J-7J(16)

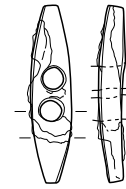

16

東側土側溝(19)

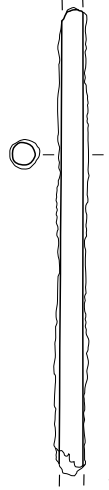

19

攪乱(20)

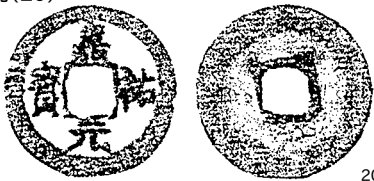

20

表採(21)

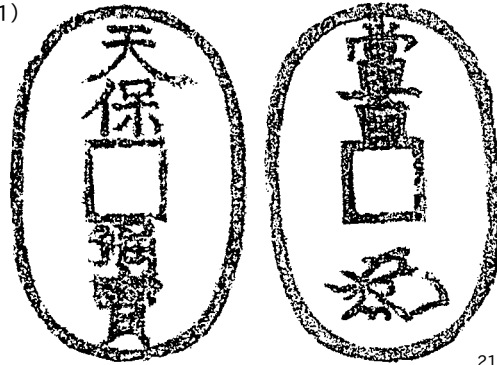

21

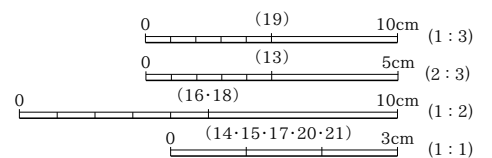

下層出土アスファルト
SK722(1・2)

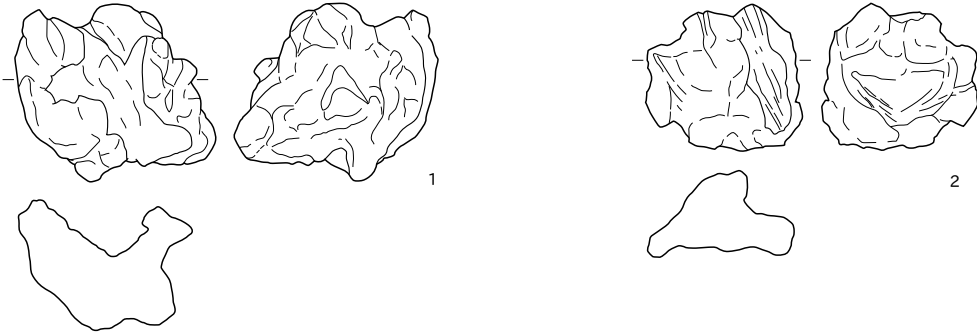

SI837(3)

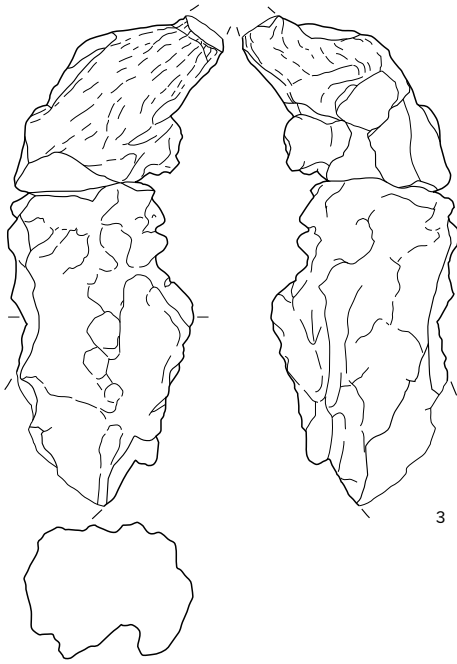

SK985(4)

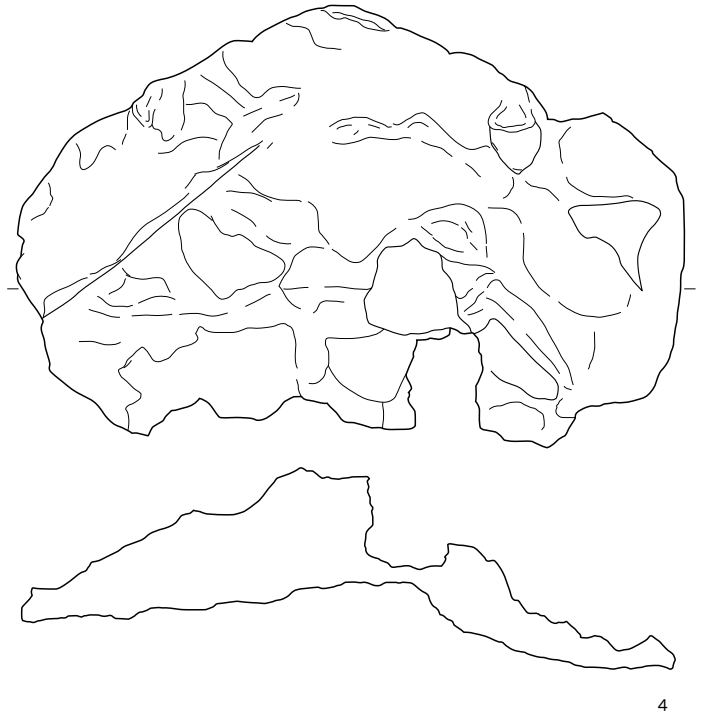

SD192(5)



4J-2D4(6)

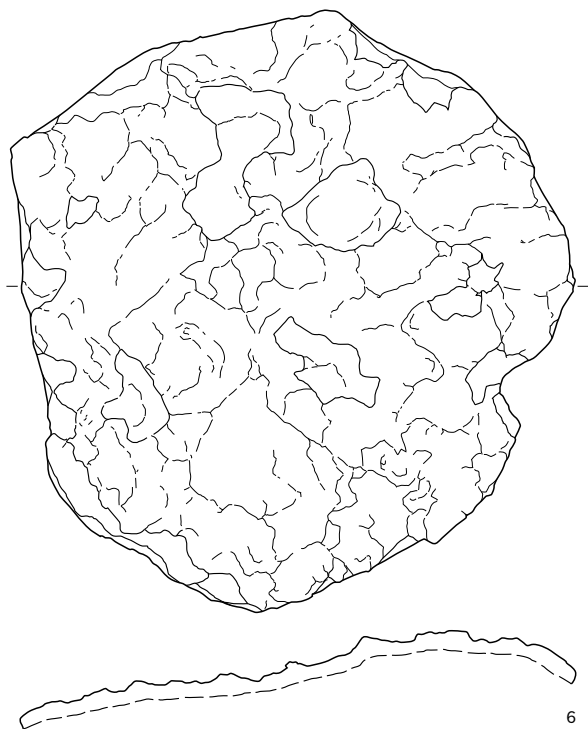

6

4J-2D5(7)



7

上層出土アスファルト
SE504(8)

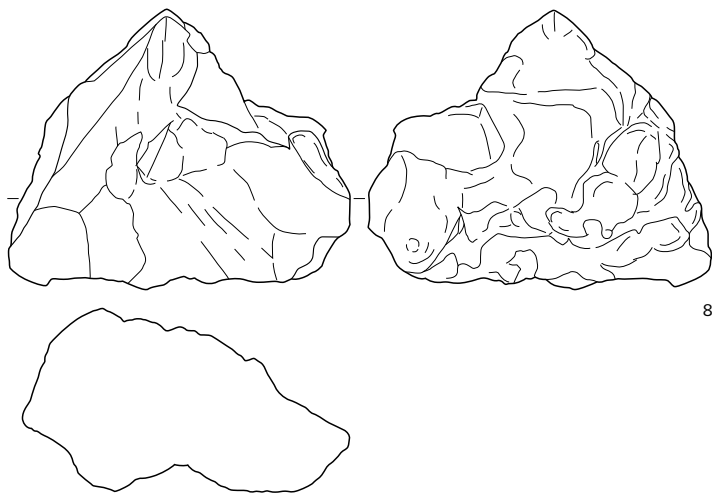

8

SD800(9)

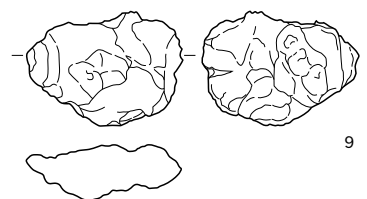

9

大沢谷内遺跡Ⅱ 第7・9・11・12・14次調査

— 一般国道403号小須戸田上バイパス整備工事に伴う
大沢谷内遺跡第2・4・6・7・9次発掘調査報告書 —

図 版 編

2012年 3月15日印刷

2012年 3月26日発行

編 集	新潟市文化財センター 新潟県新潟市西区木場 2748 番 1 〒950-1122 TEL 025(378)0480
発 行	新潟市教育委員会 新潟県新潟市中央区学校町通一番町 602 番地1 〒951-8550 TEL 025(228)1000
印 刷	株式会社 第一印刷所 新潟県新潟市中央区和合町2丁目4番 18 号 〒950-8724 TEL 025(285)7161